

BGMF KENTUCKY  
**GENTLEMAN**

Volume 8, No. 6 • May 22, 2026

TLStarcraft x Patchwork Simply Amazin by Simply Maserati



**THE  
BUSY  
BEAVER**<sup>TM</sup>

Helping you  
sell anything  
from A - Z

of  
TUCKESSEE (KY & TN)  
and BEYOND

Also Includes IA, IL, MO, MS, WI, AR,  
TX, OK, KS, CO, MN, MT, ID, NE & WY



Scan for a better  
Beaver experience

**Delivered to over 17,000 homes! Every 7 days!**  
**Exposure for your products - Like no other....**

# CATAMOUNT

CHARGE THEM BATTERIES!



## •ORGANIZE •CHARGE •SAVE ENERGY

*The catamount Charger offers  
Safe, Efficient, & Reliable DC Powered Battery Charging*

### FEATURES:

- Full communication with the tool battery for unsurpassed safety.
- Efficiently DC powered, using up to 20% less energy than an inverter with AC chargers
- 12 Volt to 60 volt input

### POWERED BY:

- Batteries: 12 volt, 24 volt, 36 volt, and 48 volt
- Solar panels (up to 24 volts)

### NEED THE SUN'S POWER?

Check Out Our Pre-Wired Solar Kits:

- KIT 1 – Charges 3–5 tool batteries per day
- KIT 2 – Charges 8–10 tool batteries per day
- KIT 3 – Charges 12–15 tool batteries per day
- KIT 4 – Charges 8–10 tool batteries per day, plus runs a 15 cu ft freezer



**CONNECT MULTIPLE UNITS  
TO MAKE THE MOST OF  
CHARGING TIME!**

Multiple chargers can be connected to each other, then to one DC charging cable.



**Models for  
DeWalt, Milwaukee,  
& Makita Batteries!**

**IN STOCK  
READY TO SHIP**



PHONE: 270-465-0821 • FAX: 270-465-0154  
898 Merrimac Rd Bradfordsville, KY 40009

### Editor's Note:

Zach is finished with school until the fall. He graduated elementary school and is now officially a middle school tween. Matthew and Evelyn have one more week to go before they are out of school. They are looking forward to swimming and camping.

The boys are signed up to go on two camp outs this summer. Evelyn is wanting to go so bad. We have decided to go on a family camp out over one weekend this summer. If everything goes smoothly we will probably do it more.

I'm looking for a good watermelon. I think it might be too soon in the year for a good one. The stores are carrying them, but I hate to spend the money and it not taste good.

Mary Brenner

Take Your Business to the *Extreme*

Pages 47, 70-71 & 84

Start your BEARABY therapy today PAGE 90

TheOUT Technique, LLC EMERGE VICTORIOUS Page 66

Health Core-TRANONT PAGE 19

Rosie's Roost Premium Organic Coffee Pages 54

Pharm-Aloe A Natural Alternative Page 72 & 88

CDI Can Do Initiatives Page 92

## Are You Prepared You're Invited!

**June 4th 2026**

**6:30 PM**

Location: Wheat Ridge Community Building  
3760 Wheat Ridge Rd West Union, OH 45693

**Hosted at Multiple Locations**

**June 3rd 2026**

**6:30 PM**

Location: Mayslick Community Building  
6398 Helena Rd Mayslick, KY 41055

**BUY 5 OR MORE GET 5% OFF**

**BUY 10 OR MORE GET 10% OFF**

**Join us for a Fire Pro fire safety presentation!**

Fires kill; fire safety knowledge saves. Many people believe that they are prepared for a fire... until they aren't. Join us for an interactive evening and learn something that can make a difference between life or death in a fire scenario! Prepare today to save tomorrow.

**The first 10 customers get a free aerosol can!**

**Free refreshments will be served.**

**Everybody Welcome!**

Hosted by: **Sunset Bikes**

For questions regarding any of these demos, please contact Darren at Sunset Bikes. 937-798-3021

## King's HAPPY EARTH Products

A FULL LINE OF CHEMICAL FREE PRODUCTS, FORMULATED AND HOMEMADE, SCENTED W/ ESSENTIAL OILS

**INGREDIENTS you can trust!**

**WHOLESALE & RETAIL**

LAUNDRY PRODUCTS

CLEANERS

BATH & BODY

CANDLES

ESSENTIAL OILS

BABY PRODUCTS

& LOTS MORE

Call today for a Free Catalog

**WE SHIP TO YOUR DOOR | FREE PALLET SHIPPING AVAILABLE**

call for more information

6285 Engletown Rd | Honey Brook PA 19344 | PH 717-768-0645 | Fax 717-208-4550

Email [happyearth@ibfay.com](mailto:happyearth@ibfay.com)

Article space donated to CAM



A channel enabling the church to minister to physical and spiritual needs around the world

**FARM ANIMALS**

# Hope in the form of chicks

Tsira was only 30 years old when her husband passed away unexpectedly. She lives in the country of Georgia which is located in southeastern Europe. Life was difficult for Tsira and her two young children. “We were left without means of support. I raised my children in great poverty,” Tsira reminisced.

Time went on and Tsira’s children got married and started their own families. Life was a little easier for Tsira, now that she had only herself to support. But recently, Tsira suffered yet another loss when her son passed away suddenly. “The loss of my son was a double blow for me. Now I live with my daughter-in-law and we are raising three fatherless children. We live in great need,” Tsira told our contacts.

“Many nights I woke up thinking about what I would feed the children in the morning,” she shared. “With tears I prayed to God for help because it was painful to see my hungry grandchildren. We were going through very difficult times.”

Once again Tsira’s life changed, this time by the gift of chicks. “God’s people brought us chicks,” she rejoiced. “What surprised us even more was that



Tsira and her three grandchildren are excited to receive chicks from CAM.

along with the chicks they also brought good quality feed!” How glad Tsira and her family were for these chicks!

“Words cannot describe the joy of seeing my grandchildren smile again,” Tsira told our contacts. “Your help showed us there are still kind and caring people in the world. Now we look to the future with hope and believe that together many things can change.”

## Response Coupon

**FARM ANIMALS (FA):** Funds to provide animals like cows, chickens, and goats in Moldova, Kazakhstan, Ukraine, and other countries

- \$50       \$100       \$250       \$500
- \$1,000     \$2,500     \$5,000     \$10,000
- \$15,000    \$25,000    \$\_\_\_\_\_ any amount

Make checks payable to **Christian Aid Ministries**  
P.O. Box 360 | Berlin, OH 44610  
To make a donation by debit/credit card, please call us at **330.893.2428**.

*A receipt will be sent unless otherwise noted.*

- Check here if you DO NOT wish to have a receipt.
- Check here if you wish to have only a year-end statement.

Name \_\_\_\_\_

Address \_\_\_\_\_

City \_\_\_\_\_ State \_\_\_\_\_ Zip \_\_\_\_\_

Phone \_\_\_\_\_



QUICKBOOK CHECKS

**CORNERSTONE**  
**BUSINESS PRINTING, LLC**  
*Equip • Empower • Elevate*

sales@cornerstone.info | promo@cornerstone.info  
 14589 US Highway 20 | Middlebury, IN 46540  
 P: 574-642-3430 | F: 574-642-4059



SALES BOOKS STAMPERS



INVOICES, PROPOSALS, CUSTOM FORMS

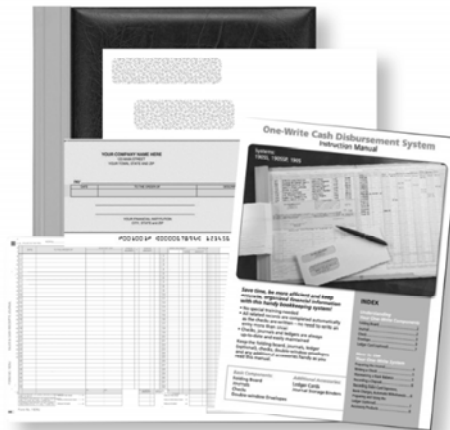

ONE WRITE CHECK SYSTEMS



PERSONAL CHECKS



BUSINESS POCKET CHECKS



CORPORATE GIVAWAYS



CUSTOMIZED DRINKWARE



EMPLOYEE APPRECIATION



TRADESHOW ESSENTIALS



BRANDED APPAREL



**BUSINESS OWNERS: CALL FOR FREE CATALOG**

# A healthy gut is the first step to a successful relationship with your dog!

# Joy Gold

Proven results under microscope.

Imagine never using dewormer again!

Use Joy Gold in your everyday feeding program and eliminate Diarrhea, Giardia and Coccidia



### GUT HEALTH:

- Removes toxicity from body
- Promote better gut health and eliminate unwelcome visitors
- When dog is healthy, increases odds of bigger litters
- It is not about selling a puppy, it is about providing healthy puppies to your client and you will have happy repeat customers!
- Helps eliminate loose stool
- Unwelcome visitors

**2 quart Canister .....\$69.98**  
**3 gallon bucket..... \$227.98**

### GUT BIOME:

- Without a healthy gut your dog will struggle
- Happy dog - happy owner
- Dogs love Gut Biome, no need for nasty tasting pastes and slurries
- Let's treat the problem/issue instead of the symptoms

**Gut Biome 16 oz .....\$46.98**

## Home, Farm, Business, Garden

Expandable system, Uses No electricity, 120 Day money back guarantee

Physically, as water passes over, around and through the helix formations inside the NU-FORCE Water Revitalizer, the actions churn the water similar to the action of water rolling and tumbling over rocks and crevices down a mountain stream. Enjoy all the benefits of revitalized water for cooking, drinking, showers or baths, laundry, gardening, pets and so much more.

Additional units can be installed where needed for even greater results.



Additional plumbing not included

Stray Voltage/ Static Unit (2 pieces) **\$1527.00**



Stainless Steel Garden Hose Unit (includes fittings) **\$598.00**



Stainless Steel Whole House Unit Unit is attached to the incoming water supply. **\$1098.00**

Soften your water Natures Way!

# The Original WATER REVITALIZER



Distributed by:



717-715-3498  
332 Hollow Road  
Quarryville, PA 17566

Dealer inquiries welcome. Call for wholesale pricing.



**CALL IN YOUR CLASSIFIED ADS!**

**1-800-355-2192**  
(Mon - Fri 8-5 EST)

Deadline:  
NOON  
Wednesday

You may also fax **1-800-574-4204** or email **classifieds@busybeaverpublicationsllc.com**

Ads must be paid with credit/debit card (call us w/ info).  
A \$3.00 convenience fee will be applied.  
All ads must be pre-paid to run.

**New! ADD AN EMOJI**

**Your ad just got more exciting!**  
Circle your emoji & draw a line to the spot you'd like it placed in your classified ad below. Easy!  
Add \$1.50 per emoji when calculating your final cost.  
*Shown actual size.*

dog tractor smiley megaphone deer star ball/bat horse scooter

**SUBMIT A CLASSIFIED AD**

Place one word only in each box below.

\$15.00 for first 12 words			
15.45	15.90	16.35	16.80
17.25	17.70	18.15	18.60
19.05	19.50	19.90	20.40
20.85	21.30	22.75	22.20
22.65	23.10	23.55	24.00
24.45	24.90	25.35	25.80
26.25	26.70	27.15	27.60

Name \_\_\_\_\_

Address \_\_\_\_\_

City \_\_\_\_\_

State \_\_\_\_\_ Zip \_\_\_\_\_

Phone# \_\_\_\_\_

**FOR FREE, include my:**

name  address  phone #  
must choose at least one

**Choosing more than 1 category?**

Remember, you must pay the full ad price for EACH category you check. Example:  
**\$15.00 ad x 2 categories x 2 times = \$60.00**

- |  |   |
|--|---|
| <input type="checkbox"/> Horses & Tack           | <input type="checkbox"/> Household/Furniture          |
| <input type="checkbox"/> Livestock               | <input type="checkbox"/> Lawn & Garden                |
| <input type="checkbox"/> Pets & Supplies         | <input type="checkbox"/> Maple/Maple Supplies         |
| <input type="checkbox"/> Poultry & Small Animals | <input type="checkbox"/> Miscellaneous                |
| <input type="checkbox"/> Beekeeping              | <input type="checkbox"/> Office Supplies/Publications |
| <input type="checkbox"/> Bicycles/Scooters       | <input type="checkbox"/> Produce/Edibles              |
| <input type="checkbox"/> Building Supplies       | <input type="checkbox"/> Produce Equip/ Supplies      |
| <input type="checkbox"/> Business Opportunities  | <input type="checkbox"/> Real Estate (For Rent)       |
| <input type="checkbox"/> Carriages               | <input type="checkbox"/> Real Estate (For Sale)       |
| <input type="checkbox"/> Clothing/Dry Goods      | <input type="checkbox"/> Rentals                      |
| <input type="checkbox"/> Construction Equip.     | <input type="checkbox"/> Sawmill Equipment            |
| <input type="checkbox"/> Crafts                  | <input type="checkbox"/> Services Rendered            |
| <input type="checkbox"/> Electrical/Solar        | <input type="checkbox"/> Shop/Tools                   |
| <input type="checkbox"/> Farm Related            | <input type="checkbox"/> Special Events/Notices       |
| <input type="checkbox"/> Garage Sales/Benefits   | <input type="checkbox"/> Sporting Goods               |
| <input type="checkbox"/> Greenhouse/Growing      | <input type="checkbox"/> Transportation/Taxi          |
| <input type="checkbox"/> Hay/Straw/Feed          | <input type="checkbox"/> Wanted Items                 |
| <input type="checkbox"/> Health/Naturals         | <input type="checkbox"/> Lost & Found/ Free Items     |
| <input type="checkbox"/> Help Wanted             | <i>(No Charge, 1 time only)</i>                       |

Payments for classified ads in one or multiple issues are **NON-REFUNDABLE.**

**Mail this form AND check payable to: Busy Beaver of Tuckesse & Beyond P.O. Box 3 Charm, OH 44617**

**MAIL-IN classified questions: CALL 330-204-9199**

**Next TK DEADLINES**

**May 27**  
**June 3**  
**June 10**

<b>1</b>	<b>\$15.00 first 12 words</b> 45¢ each additional word per each Ad Category Cost for ONE TIME
<b>2</b>	EMOJI 🐻 how many? \$1.50 ea.
<b>3</b>	<b>SUBTOTAL</b> ADD box 1 + box 2
<b>4</b>	PENNSYLVANIA how many issues
<b>5</b>	OHIO how many issues
<b>6</b>	MICHIANA how many issues
<b>7</b>	NEW YORK how many issues
<b>8</b>	TUCKESSEE how many issues
<b>9</b>	TOTAL Number of issues (add boxes 4-8)
	<b>TOTAL COST</b> (Multiply box 3 x box 9)

**Helping you sell anything from A - Z!**

# Display Ads

**IMPORTANT:** We do not publish ads without a full ad order and print-ready PDF file (both must be received by deadline).

**MULTIPLE TIME DISCOUNT GUIDELINES:** In order to enjoy the multiple time rates listed here (12-25 time or 26-52 time rate), you must schedule specific edition dates and ad size must remain the same for the entire run. You may send new artwork for each time. If nothing new is received by the deadline, we will re-run from the previous edition.

**DESIGN SERVICE?** Sorry, in order to keep placement costs low for everyone, we do not offer design services at this time, so be sure your file is submitted print-ready.

**WORKING WITH A DESIGNER?** If a third party is sending your ad file, be sure he/she includes all required ad order information from the submission form. Or, you may contact us with the required info by calling the Busy Beaver of Tuckesse and Beyond at 800-886-2704.

**Pricing** All prices shown are *PER TIME*

Full Page 7.4" w x 9.6" h	Discount	B&W	COLOR
1-11 times (or ads)		\$312.00	\$412.00
12-25 times (or ads)	5%	\$296.40	\$391.40
26-52 times (or ads)	10%	\$280.80	\$370.80

1/2 Page Horizontal 7.4" w x 4.7" h or Vertical 3.6" w x 9.6" h	Discount	B&W	COLOR
1-11 times (or ads)		\$204.00	\$262.00
12-25 times (or ads)	5%	\$193.80	\$248.90
26-52 times (or ads)	10%	\$183.60	\$235.80

1/4 Page Vert. 3.6" w x 4.7" h	Discount	B&W	COLOR
1-11 times (or ads)		\$133.00	\$171.00
12-25 times (or ads)	5%	\$126.35	\$162.45
26-52 times (or ads)	10%	\$119.70	\$153.90

Business Card Horiz. 3.5" w x 2" h	Discount	B&W	COLOR
1-11 times (or ads)		\$ 66.00	\$ 86.00
12-25 times (or ads)	5%	\$ 62.70	\$ 81.70
26-52 times (or ads)	10%	\$ 59.40	\$ 77.40

**Classified Section Only Ads**

2 x 2 Display Ad 2.33" w x 2" h <b>PREPAID</b>	Discount	B&W	COLOR
1-11 times (or ads)		\$ 54.00	\$ 54.00
12-25 times (or ads)	5%	\$ 51.30	\$ 51.30
26-52 times (or ads)	10%	\$ 48.60	\$ 48.60

Business Card Vert. 2.3" w x 4" h	Discount	B&W	COLOR
1-11 times (or ads)		\$ 80.00	\$102.00
12-25 times (or ads)	5%	\$ 76.00	\$ 96.90
26-52 times (or ads)	10%	\$ 72.00	\$ 91.80

Banner Ad Horiz. 7.5" w x 1.5" h	Discount	B&W	COLOR
1-11 times (or ads)		\$123.00	\$155.00
12-25 times (or ads)	5%	\$116.85	\$147.25
26-52 times (or ads)	10%	\$110.70	\$139.50

Banner Ad Vert. 2.3" w x 8.25" h	Discount	B&W	COLOR
1-11 times (or ads)		\$141.00	\$178.00
12-25 times (or ads)	5%	\$133.95	\$169.10
26-52 times (or ads)	10%	\$126.90	\$160.20

1/4 Page Horiz. 4.8" w x 3.6" h	Discount	B&W	COLOR
1-11 times (or ads)		\$152.00	\$194.00
12-25 times (or ads)	5%	\$144.40	\$184.30
26-52 times (or ads)	10%	\$136.80	\$174.60

3/8 Page Vert. 4.8" w x 5.9" h	Discount	B&W	COLOR
1-11 times (or ads)		\$178.00	\$230.00
12-25 times (or ads)	5%	\$169.10	\$218.50
26-52 times (or ads)	10%	\$160.20	\$207.00

WE RESERVE THE RIGHT TO REFUSE ANY ADS WE DEEM INAPPROPRIATE.  
 Busy Beaver of TK is not responsible for the outcome of products advertised within.

# SUBMISSION FORM

Ad Size: \_\_\_\_\_

Print my ad in:  B/W  COLOR

How many times should we print your ad? \_\_\_\_\_

If more than 1 time, print my ad...

consecutively  every other issue  once per month

specific dates \_\_\_\_\_

How will we receive your ad?  Mail  Email

Do we have your ad already on file?  Yes  No

How will you pay?  Payment is enclosed  Send me an invoice  
**2x2 Display Ads must be prepaid**

**BILLING INFORMATION:**

Business Name \_\_\_\_\_

Contact Name \_\_\_\_\_

Billing Address \_\_\_\_\_

Billing City/State/Zip \_\_\_\_\_

Phone \_\_\_\_\_

**Mail:**  
 Return this form and a clear, ready-to-scan ad to **Busy Beaver of Tuckesse and Beyond PO Box 3046, Clarksville, TN 37043**

**OR**  
**Email:**  
 Email required info from this form and a print-ready PDF ad file to **bbtuckesse@gmail.com**

## Have you moved? -or- Want to Subscribe?

and want your Busy Beaver of Tuckesse and Beyond to arrive in your new mailbox?

These horse and buggy residents are eligible for a free Tuckesse and Beyond subscription: TN, KY, IA, IL, MO, MS, WI, AR, TX, OK, KS, CO, MN, MT, ID, NE & WY.

**Out-of-state OR non-horse and buggy folks:**  
 Return this form and a \$50/year check payable to "Busy Beaver of Tuckesse and Beyond".

Fill in your old and new address below.

**Old Address (for change of address request only)**

Name: \_\_\_\_\_

Address: \_\_\_\_\_

City: \_\_\_\_\_ State: \_\_\_\_\_ Zip: \_\_\_\_\_

**New Address**

Name: \_\_\_\_\_

Address: \_\_\_\_\_

City: \_\_\_\_\_ State: \_\_\_\_\_ Zip: \_\_\_\_\_



Mail completed form to:  
**Busy Beaver of Tuckesse and Beyond PO Box 3046 Clarksville, TN 37043**

Please allow 3-4 weeks for your subscription to become active.



**Sell your horse in the**  
Busy Beaver

# Horse Corral

\$85 first region (5 Available Regions: PA, OH, MI, NY, TK)  
\$65 each additional region

**Deadline is**  
**Thursdays at noon**

**330-201-9582**



To trot your horse in the corral contact: [horsecorral@busybeaverpublications.com](mailto:horsecorral@busybeaverpublications.com)

CLASSIFIEDS



\$15,000

4 y/o Morgan Mare. S: Merri Hill After Hours, Dam by Mizrahi. Rides & Drives. 574.364.0849



\$8,500 OBO

8 y/o Mare. S: Conway Court, SOD: Mr Lavec. Big. Travels good. TSS. Women broke. 618.417.0249



\$14,200

6 y/o Mare. My MVP x Conway Hall. Buggy broke. Long & Stretchy. Would make good broodmare. 16.2hh. 330.521.1299



\$2,750 PKG

5 y/o Shetland Stallion with cart & harness. 606.210.1050



\$1,200 OBO

15 y/o Arabian Gelding. Broke to ride. 606.210.1050



\$5,400

OH,PA,TK  
Eli Miller

3 y/o Reg Morgan Stallion. S: LGB Richard, SOD: JMF Irish Coffee. Broke to ride/drive. 606.209.1588



\$6,000 OBO

6 y/o Friesian Morgan Mare. TSS. Horse for wife w/children. 620.953.2334



\$15,000

16.2hh Mare. S: Daniel Diamond by Kadabra, D: Pinetucky. Sweet Mare. For more info, Please call 563.880.1986



\$11,000

TK (OH Filler)  
Marvin Yoder #2

16.1hh Mare. S: Crazy Royal, D: Pine Springs. For more info call 563.880.1986



**Sell your horse in the Busy Beaver**

# Horse Corral

**\$85 first region (5 Available Regions: PA, OH, MI, NY, TK)  
\$65 each additional region**

**Deadline is  
Thursdays at noon**

**330-201-9582**

**To trot your horse in the corral contact: [horsecorral@busybeaverpublications.com](mailto:horsecorral@busybeaverpublications.com)**



Reg Gypsy Stallion, headed to 5 Star Auction, May 30. Any questions call 563.880.1986



**\$2,750**

14 y/o Stdb Broodmare w/Colt. S: Rakety Tam, D: Dream Of Glory, SOSD: King Conch. 417.262.4475



**\$18,000 OBO**

8 y/o M. Father Patrick x Muscle Yankee, 2NDD: Pine Chip. TSS. Drives w/tight lines. Good commercial pedigree. Foal is KY elig. HCP. 440.226.0364



**\$4,000 OBO**

5 y/o Belgian Mare. Broke & Ready for the fields. 606.210.1050



**\$3,500 OBO**

3 y/o Belgian Gelding. Broke to lead. 606.210.1050



**\$11,500**

PA,MI (TK Filler)  
Nate Troyer

3 y/o Mare. Marsielle x Pinetucky. Fresh. Started to buggy. Pretty. 440.855.2667



**\$18,500 OBO**

8 y/o M. Kan Classic x Bands Gold Chip x Overcomer. 15.3hh. Blk & Pretty, Fast, Fancy, Fun. Sound. Personal 3yrs. Bred to Jasper The Man. 812.486.8884



**\$3,000**

14 y/o M. Cash Hall x Conway Hall x Pine Chip. 16.1hh. Sells mostly as Broodmare. Shortbred to Royal Trump. 812.486.8884



**\$9,500 OBO**

PA,MI,TK (OH Filler)  
Lester Raber #3

12 y/o M. S: Neely Dunn x Like A Prayer x Garland Lobell. 16.1hh. In foal to Royal Trump. Sells w/pd. breeding to Royal Trump for '26. 812.486.8884

**HORSES & TACK**

**1 Dreamster contract. LFG. \$1,200.00.**  
717-201-9126

**1 y/o bay Accurate Citation** x Guccio colt. \$4,000.00 OBO. 717-490-1819

**1 y/o Sorrel Stud STB** Pony cross 4 whites, star. Call Information. Sam Schwartz 2222 Turner Rd Flemingsburg, KY 41041, 606-407-1980

**14 Y/O Dark Bay broodmare** Reg# 5k262. Sire Western Terror SOD Real Desire. \$3500.00. 731-415-1794

**2 y/o mare. Tactical Landing** x Groton Hall. Fresh. Lots of potential. \$9,500.00. 330-600-7885

**2 y/o Percheron gelding, Sired** by Spring Waters Ozzy, started in harness. 260-739-2843

**2 y/o stud by Newtown Chocolatier/** Incredible Abe. Ready for training. \$3,800.00. 517-270-8303

**2- 2026 Breedings available to** Uppiter Laksmey, \$1,250.00 a piece or \$2,250.00 for both. 519-595-7402

**2026 Breeding Contract to Master** Plowden. LFG, \$1,100.00 OBO. 260-383-1424

**2026 breeding to Mister Sunchip,** make offer. 330-521-8794

**3yr old red sorrell Belgian** geldings half brothers 16.3H Broke to most farm machinery, ready for a full time job. Nice team! They Back well and respnd nicely to Gee and Ha- \$4400. each 7Y/O red sorrel Belgian Mare 16.2H Broke to all farm machinery. Tough and willing! \$3500.00 Joel Brubaker 11178 S 1150 Road Rich Hill, MO 64779

**2026 only Four White Socks** breeding contract. \$2,800.00. 231-349-7283

**4 y/o Standardbred gelding Cantab** Hall son X Federal Flex X Sierra Cosmo X Balanced Image. 16+H, black bay with star. A very chunky gelding, 100% in all ways. Old men and Ladies can drive him, but extremely fancy, one cool dude. \$11,500.00. 260-760-1288

**4 y/o Standardbred mare a** Credit Winner Son X Chip Chip Hooray X Conway Hall X Self Possessed X Worthy Bowl. 16H, bay with star and 1 white ankle. This mare has a loaded pedigree, bomb proof, anyone can drive her but very heads up and fancy. Very quiet mare in the barn. Comes with a Newtown Chocolatier breeding. Asking \$14,000.00. 260-760-1288

**4 y/o STB gelding by** Carland Eddy/ Spirit Seeker. 16.1H, handsome trotter. Family broke. \$5,500.00. 517-270-8303

**4Y/O fresh trotting mare 16h** a pretty mare that drives nice, also has some commercial family. Sire: Propulsion Dam: Broadway Hall 2nd Dam: American Winner. \$8,750. OBO. Charms Rocket 2026 Breeding LFG usually \$3,000. for only \$1,500. 330-275-4146 or 330-473-3595

CLASSIFIEDS



**Is Your Horse Struggling With One Of The Following??**

- ⌘ Under Weight / Hard Feeder??
- ⌘ Parasites / Bad Hair Coat??
- ⌘ Tying Up / Kidney Shot??
- ⌘ Kidney / Liver Problems??

**Consider Doing a Haarlem Oil & or Agri-Cleanse Detox!!**

Our **Genuine Haarlem Oil** is the original Mr. Tilli formula dating back to 1696. The power of this Haarlem Oil comes from the sulphuric amino acid content. This is a form of bio available sulfur that is immediately utilized. The higher the percentage of sulfur, the more effective it will be. Our Haarlem oil is 16% Sulfur, the highest percentage you will find on the market!!



Oregon Ag LLC 717-656-0067 1150 E Oregon Rd, Lititz PA 17543  
Agri-Tonic \* Repro-Plus \* Equi-Sentials \* Agri-Cleanse

**Display Ad Sales**

**Busy Beaver Publications**

**Virgil Raber**

**812-642-7076**

vraber@busybeavertuk.com



**All ads are appreciated! Any Size. Any Color.**

*Classified ads? Refer to page 7.*

## HORSES & TACK CONTINUED

**4 year old Muscle Network** LockKeeper Mare with a Winning American stud colt on the side. \$8500.00 James Detweiler 21907 170th St Bloomfield, IA 52537, 641-242-2733

**4yr. old Friesian/ Stbd. mare.** S:BrylantZJN SOD: Jailhouse Jesse. SOSD: Donerail. TSS, 16HH, boys horse deluxe. In foal to LNS Dust N Deisel Smoke who is sired by Ledgefield Potenza \$10,600. Alton Miller 5800 Kansas Ave SW Riverside, IA 52327

**5 Y/O Bay Reg DHH** Stallion sire: Maxin SOS: Ccraaf Kelly SOD: Atleet. Throws colts with chrome and style. Buggy broke. TSS \$4000.00 Also yearling pony stud colt 42". In your pockets type. \$1200.00 Cold Valley Stables 19226 City Hwy N Tomah, WI 54660

**5 y/o mare, Neely Dun** x Crazed, 16.2HH, long neck, well broke, and sharp. solid built, ready for miles, TSS, \$12,500.00 OBO. 7 y/o mare, Cantab Hall x Muscles Yankee, 16.1HH, long neck, well built, TSS, the kind we all like! \$11,500.00 OBO. 5 y/o mare, Muscle Mass son x SJ's Photo, Sierra Kozmos. Solid built, four whites, TSS, \$9,000.00 OBO. 4 y/o mare, EL Phantom x Chocolatier, fresh and pretty, \$9,000.00 OBO. Trucking available. 315-730-1598

**5 y/o Stallion Mohegan Hanover** His Highness Pine Chip, 2 yearling fillies from this stallion, need to sell. Stephen Shetler 77 W 100 S Monroe, IN 46772, 202-826-6587

**For Sale: 3 yr. old** mare, light bay, 2 whites, stripe, TSS, Very pretty, Jasper J x His Highness x Arnie's Exchange. HCP \$14,000. OBO. 440-855-9036

## LIVESTOCK TRANSPORT

**Pennsylvania  
to  
Missouri**

**DR Livestock**

**484-796-3952**



ULTRASOUND MACHINES STOCKS PHANTOMS AVAILABLE



**KAYCEE'S**

(330)390-6012

SALES@KAYCEESOH.COM

DEALER  
INQUIRIES  
WELCOME

**7 y/o STB gelding, Dewycheatumn-howe** son x Cincinatti Kid, 16.1HH, dark bay, big solid gelding that absolutely anyone can drive, bomb proof in every which way! Beautiful long neck, very up headed, extremely fancy, \$7,800.00. 260-760-1288

★ **8 y/o Morgan mare** by ICF Reasonably Certain filly at side by Queen's Sebastian. Very sharp and upright. Both mare and colt (Broke) \$6,500.00 OBO. 31903 Township Rd 236 Fresno, OH 43824, 330-897-0178

**"Agri-Tonic," Great option for Strangles,** Pneumonia, Colic, EPM, West Nile, Poor Body Condition, Low Energy, etc. Available at your local Agri-Tonic Dealer. Oregon Ag LLC 1150 E Oregon Rd Lititz, PA 17543, 717-656-0067

**For Sale 4 y/o bay** STB mare, stands around 16 hands, TSS, buggy broke, a good traveler, \$5,800. 3 y/o bay STB gelding, stands around 16 hands, TSS, buggy broke and a boys horse, \$5,800. Andy Bontrager Oseeola IA, 641-414-9753

**For Sale! 8 y/o big** black stallion. Strip and 3 whites. Sire Sierra Storm, SOD: Mr Lavec, SOSD: Dream of Glory. Call for more info 641-242-2640

**P.E.P.**  
INNOVATION MEETS EQUINE EXCELLENCE

**MOTOR OPTIONS**  
● GAS  
● ELECTRIC

FINANCING AVAILABLE

FINANCING AVAILABLE

NOW AVAILABLE  
IN PONY SIZE

**Distributed By**

**KAYCEE'S**  
(330)390-6012  
SALES@KAYCEESOH.COM

**DEALER  
INQUIRIES  
WELCOME**

**Looking to buy well broke** draft crosses for riding. Any age as long as they are gentle and calm. Please call 252 943 1724

**“PF Wonder Salve,” Proud Flesh Cure, Heal wounds without scars. Proven Results!!** Available at your local Agri-Tonic Dealer. Oregon Ag LLC 1150 E Oregon Rd Lititz, PA 17543, 717-656-0067

**Quarter horse yearling bay roan,** Catt sophisticated. \$5750. Quarter horse mare, confirmed breed to son of Stevie Reyvon. 12 yr.old Colonol Freckles bay, located in ARK. \$4,500. 731-518-6184

**Registered Morgans for sale. 3 yr old** chestnut mare, started under saddle, in foal, \$3600 OBO. 8 yr old chestnut mare, up-headed, not for women, \$5200 OBO. Black yearling filly, pretty, \$2200. Brown yearling filly, Grunden Ranch Breeding, \$1800. 717-947-0461

**Standing at Stud: Russian Orlov Trotters,** black with white markings, one is homozygous black, \$700 and \$800 fees, both are proven by offspring on the road. They are performing with extra stamina and an effortless trot averaging 12-15 mph, with a few surpassing that. Farbig Farm 61788 Co Rd 35 Goshen, IN 46528, 574-825-3943

**For Sale: 19 yr. old** registered standardbred mare. Black w/star and one white sock. Sire: Rail Splitter Dam: Sandy Becc. Sire of dam: Sand Chaser. She came up open this year again. Still very drivable. Nice well built gritty mare. \$5,000. OMO For more info call Kathy 608-629-5284

**For Sale: 3 y/o black** Dutch cross gelding. Top buggy broke. Needs miles. \$3,500.00. 641-242-0559

**For Sale: 4 yr. old,** 16.1H Standardbred gelding, bay w/one white sock, TSS, Sire: Stonebridge Lord. He is pretty much blind, still has some eyesight, but not much. Very well broke gelding thats ready for the surrey or ladys horse. Stands to hitch and at corners. He will do anything for you. Not fast but steady. \$4,000. OMO call Kathy for more info. 608-629-5284

**Fresh mares available: 4 y/o** Muscles Mass EL Titan 16H, commercial value. 3 y/o Don't Let Em/Andover Hall 16H black with chrome, pretty. Call 330-521-8794

**“Genuine Haarlem Oil for Horses,”** Stimulates liver, kidney, and urinary tract functions. Eliminates and prevents parasite problems. Less problems with colic, tying up, arthritis, thrush, scratches, etc. Cheap insurance for your horse's health! 200ml bottle for \$35.00, 6 or more \$32.00. Available at your local Agri-Tonic Dealer. Oregon Ag LLC 1150 E Oregon Rd Lititz, PA 17543, 717-656-0067

**Purebred Gypsy Vanners, several blue** roan studs, bred and open mares, and crossbreds. Also, quarterhorses, top bloodlines, Metallicat, One Time Pepto, and others, ready to train. 608-726-0903

*Poole Forge*  
**STABLES**

**EQUINE TRANSPORTATION  
AVAILABLE:**

**BI-WEEKLY: PA-IN-MI  
MONTHLY: KY-NY-MD-DE-VA**

**WILEY KING  
717-271-8254**

**CALL FOR SCHEDULING**

**WILEY@POOLEFORGESTABLES.COM**

## HORSES & TACK CONTINUED

**Lucky Chucky for stud service.** Call for details. Owned and standing at Clearview Farm 5630 IN-120 Shipshewana, IN 46565, 260-214-5009

**STB Stallion Classic Li'l Bro.** Sire: four starz Robro, Dam by: Kan classic. A young 16.2H stallion with a long neck, Pretty head, conformation and pedigree, \$600.00 fee due upon live foal. write with phone# for first contact. Travis Stauffer 1421 E 700 Ave Shobonier, IL 62885

**Team of 13 y/o Belgian Geldings.** Half brothers, well matched. Broke the best. \$15,000.00 OBO. Salem, MO. For more info, call 573-996-8584

**Team of 2 year old Blonde Belgian Mares.** Green Broke. A nice young team that is ready for work! Exposed to Belgian stud for 2027 \$4250.00 each Sammie Schrock 4346 300 St Stanberry, MO 64489

**Wanted: 2026 Breeding for Majestic Monarch.** 330-260-2123

**Yearling Reg Blue Roan Gypsy Pony Cross Filly,** \$4,000.00. 2y/o Reg. Palomino QH Gelding, \$6,500.00. 2y/o Stdb Cross Mare, black/bay w/chrome, \$6,000.00. 641-895-7862.

9<sup>th</sup> Annual

# MIDWEST PONY AUCTION

## Friday, June 12th, 2026

at the Timberline Arena  
23783 320th St. • Jamesport, MO, 64648



- Driving at 2:30 p.m.
- 4 p.m. Stallion Presentation followed by the Pony Sale

Bring the Kids and Enjoy the Evening!

### 150 Head of Ponies to Sell!



**AUCTIONEERS -**  
**Robert Helmuth & Calvin Raber**

Email: [Sunshinefabrics@ibyfax.com](mailto:Sunshinefabrics@ibyfax.com)

Fax: 660-620-8310

To Consign Call David Gingerich 660-684-6481

For Catalog or Questions Call Steven Graber 660-605-0806



We Reserve the Right to Reject Any Buyer #'s, Consignments, or Bids.

## LIVESTOCK

**22 head CAE free doelings.** Mostly Alpine genetics. Born Jan. and Feb. Dams peaked at 12# RHA on our own hay. 🐾 Last years BF average was 3.64 and pro. ave 2.77 Dewormed. Easy hand milkers. \$375. each OBO. Levi Schrock 2975 430 Rd Stanberry, MO 64489

**Livestock Concentrate 100% Natural.** Aids in animals digestive system for horses, cows, veal calves, goats, sheep, hogs. Faster weight gain, good bone structure, fights against hostile viruses and bacteria. Good for scours. 1pt\$19.00 SH\$8.00, 1qt\$30.50 SH\$8.50, 1gal\$88.00 SH\$12.00. OH residents add 6.75% sales tax. Schlabach Supplies, 8908 Barrs Mills Rd. NW, Sugarcreek, OH 44681. 330-897-0150

Deadline is  
Thursdays at Noon

# Horse Corral

330-201-9582

horsecorral@busybeaverpublications.com

*Are you thinking about selling your horse in the Horse Corral?*

**Tip:** For a better quality picture make sure to take your picture from the sunny side it will print much lighter.

Picture taken on the shadow side ←

Picture taken on the sunny side →

Bird-in-Hand Pet Structures



**DEPENDABLE SOLUTIONS FOR DOG BREEDERS**

**BEST SELLERS!**

Water Nibbles Always Fresh Water \$15.19 Brackets: \$33.75

Elite Nutrition A.S.A.P Puppy 5 pk \$36

4 lb Stainless Steel Feeder w/Lid \$48.94

Giraffe Tools Retractable Hose Reel \$249.75

470 Millwood Rd. Willow Street, PA  
717.435.8222 ext 102  
**Call for a Catalog**

Vaccines, Grooming Supplies, Trusscore Panels & Trim, Andis Clippers & Blades

CLASSIFIEDS

**9 Jersey heifers. Some fresh, some springing, A2-A2 tested.** \$2,500. Call 8-8:15Am Mon. Wed. Fri. Jacob Yoder 2792 N Convict Rd Sharpsburg, KY 40374, 606-247-5634

**“Agri-Min,” Minerals, Vitamins, and Direct Fed Microbial** premix for all animals. Better Body Condition, Better Reproduction, Less Foot Problems, Less Pneumonia. Great free choice option. \$40.00 for 50lb bag. Available at your local Agri-Tonic Dealer. Oregon Ag LLC 1150 E Oregon Rd Lititz, PA 17543, 717-656-0067

**2 y/o Welsh Corgi female.** Stunningly beautiful blue merle! Fluffy! Bred to a fluffy red/white Corgi stud! Due 7-10-26. Male also for sale. 2 1/2 y/o blue merle female. Fluffy! Bred to a triple-clear tri-color fluffy. Due 7-12. 4 y/o blue merle female. Mom to both above. Bred to a tri-color fluffy. Due 7-15. Call/text for price/photos. L H Corgis 265 Weidmansville Rd Ephrata, PA 17522, 717-201-0780

**4 Maltese female puppies for sale,** DOB 4/5/26, AKC registered, Imported Champion Korean bloodlines. Parents are genetic tested clear. Call for more information. 812-295-6032

**6-run Kennel for sale. 10’** outside runs, 4’ and 6’ inside runs. Total width 22’. Made by Trail Farm Supply. Also, some accessories, feeders, waters and whelping box, \$5,000.00. Can send pictures. 440-313-3311, Eve or 440-636-3120, Day

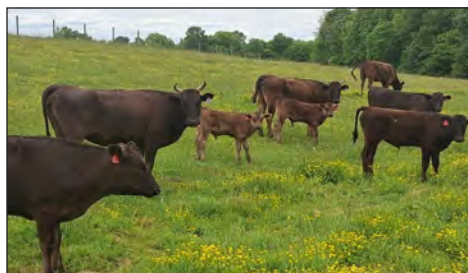

Fullblooded registered Wagyu. Open heifers or cow calf pairs also feeder steers available. Call 270-268-0652 for your Wagyu needs.

**Dairy goat Doelings, CAE negative,** high production genetics herd, Jan. Feb. kids. \$475. We have Doelings available every year. Eden Farm 250 N 500 E Rockville, IN 47872, 765-569-7235

**Jersey Family cow A2A2 2nd** Laction \$1600.00 has been expose Nice milker Joe Troyer 3458 Harriet Rd Hillsboro, OH 45133

**Mini Jersey cow. In milk, 43.5”** Polled, had 2nd calf in April. Bred back to A2 painted bull. 2 y/o mini Jersey Bull, 39”. Polled. Package deal, \$9,000.00 OBO. Dusty Rose Ranch 740-485-0983

**PETS & SUPPLIES**

Looking to buy a variety of puppies-good prices. 716-949-5941

*Signature* — CARTS BY P.E.P.

**Sulky Cart Options**

- Air Ride
- Torsion
- Coil Spring
- Bench Seat
- Quick Hitch Shafts
- Air Tire Wheels
- Flat Free Wheels
- Steel Wheels
- Light Kit

**Jog Cart Option**

- Long Shafts
- Quick Hitch Shafts
- Bench Seat
- Light Kit

FINANCING AVAILABLE

**Distributed By**

**KAYCEE'S**  
(330)390-6012  
SALES@KAYCEESOH.COM

**DEALER INQUIRIES WELCOME**

## PETS & SUPPLIES CONTINUED

**AKC Mini Dachshund Cream male** puppies. Born 4/10/26. UTD shots, dewormed. Very cute, out of good stock. Goshen, IN. 574-862-7185

**AKC miniature Poodle male, black tri-parti.** DOB: 8/1/25. Health clear, bright tan points, atat, kyky, Bb, 15lbs. 260-593-0987

**AKC red toy Poodle males** born 1/17/26. Health clear, one is no parti and one is 1sp., kbky. Parents are 6-7lbs. 260-593-0987

**AKC toy Poodle male born** 12/6/25. Black and rust, 5.12lbs., atat Bb Ee, 1sp, cddy, cdpa. 260-593-0987

**AKC toy Poodle male born** 12/6/25. Red gold color, 4lbs.12ozs. Health clear, atat ee kyky, 1sp. 260-593-0987

**AKC toy Poodle male born** 6/5/23. Chocolate tri-parti proven male, 5lbs., aat, Ee, bb, kyky, 1 cddy. 260-593-0987

**Are mice getting into your feed bags?** We have high quality, Poly horse feed and dog food carts that will last a long time. Also, tack boxes and farrier carts. Keystone Sales 332 Hollow Rd Quarryville, PA 17566, 717-715-3498

**Are you having problems with your dogs or puppies?** Eliminate diarrhea, Giardia, and Coccidia. Joy Gold Gut Health and Joy Gold Gut Biome is a natural and very effective way to eliminate these problems. Imagine never using dewormer again. It works! Keystone Sales 332 Hollow Rd Quarryville, PA 17566, 717-715-3498

**CHAMPION bloodline pup stud serviced.** Shipped semen available. Honey Brook, PA. 484-703-7554

**Brand new stainless steel dog** kennel runs, dividers are 40" high and 16' long, fronts are 40" high and have doors, will make 9-5'x16' pens, call for more details. 260-350-4766

**Puppy heaters propane/ natural gas.** New and used units available. GDM Dens LLC 895 Centerville Rd New Holland, PA 17557, 607-243-9718

**FOR SALE OR lease: Established** website [ohiocorgis.com](http://ohiocorgis.com), with 7-female, 2-male adult Welch Corgis and 5 younger breeding stock pups, all AKC registered, serious inquiries only. Joe Raber 330-473-8955

 **GDM**  **Pet Supplies** dog clippers, vaccines, wormer, dog feed, underground fences, pet carriers, dog kennels, new/ used whelping dens. Free catalog. GDM Dens LLC 4491 NY-14A Dundee, NY 14837, 607-243-9718

**Got Puppies? Accepting full & mixed** breed Adults! Get the price you deserve for your dogs! 419-551-7492

**PetSafe 900yrd wireless training collars** 50%OFF. Regular \$179.95, Sale \$89.98. GDM Dens LLC 4491 St Rt 14A Dundee, NY 14837, 607-243-9718

**Puppy Plus 100% Natural. Supports** immune gut, better heat cycle, increased reproductive and fertility, more puppies per litter, chubby healthy puppies. Stronger bones, weaning less stressful, supports diarrhea, benefits kennel cough, odor reduction. 1pt-\$19.00 SH-\$8.00, 1qt-\$30.50 SH-\$8.50, 1gal-\$88.00 SH-\$12.00. OH residents add 6.75% sales tax. Schlabach Supplies, 8908 Barrs Mills Rd. NW, Sugarcreek, OH 44681. 330-897-0150

**Purebred Blue Heeler puppies. Natural** stub-tailed, shots and dewormed. 330-359-5730

## POULTRY & SMALL ANIMALS

**Hatchery Business for Sale! Must** use electricity/ phone/ internet. We hatch and ship day old quail, operating since 2018! Great income for seasonal business! Contact Kristin Mell 414-640-9063

Strength You Can Trust. Quiet You Can Hear.

# HERE'S HOW:



## BECOME A DEALER TODAY!



- Built for **maximum durability** without sacrificing convenience.
- **Solid aluminum channel shaped perimeter** for maximum strength.
- Choice of impact-resistant clear or tinted polycarbonate, or insulated aluminum pannel.
- **Quieter kennels** lead to calmer dogs and happier staff.
- Covered by a **2-year manufacturer's warranty.**

**UPGRADE YOUR DOG  
DOORS TODAY.**

**COSI METAL FAB**  
610-273-3014

590 Beaver Dam Road, Honey Brook, PA 19344

**Poultry Booster 100% Natural. Happy** hearty healthy chickens, increase egg production with deep yellow egg yolks, eggshell development, greater percent hatchings, more energy during stress. Broilers faster weight gain, stronger bones. Chicks: head start less loss. 1pt \$19.00 SH \$8.00, 1qt \$30.50 SH \$8.50, 1gal \$88.00 SH \$12.00. OH residents add 6.75% sales tax. Schlabach Supplies, 8908 Barrs Mills Rd. NW, Sugarcreek, OH 44681. 330-897-0150

**BUILDING SUPPLIES**

**50'x100' Barn, Trusses and Roof** metal only Trusses are Hochstetler clearpan steel with 7' Attached posts used, But in good condition. Disassembled and ready to load \$8200.00 four available, Also some 20' used yellow Pine 2x4s \$2.00 each John Troyer 13323 E Indian Line Rd Richards, MO 64778

**CENTRAL BOILER OUTDOOR FURNACES.** **Traditional** and high efficiency available. Parts, accessories, insulated underground piping, and HITZ-HALTER radiant floor heat insulation and supplies in-stock. Southern KY Wood Furnaces, 8263 Glasgow Rd Burkesville, KY 42717, 270-459-1840.

**PVC Sheeting**

All sizes listed are 4' x 8', 9', 10' or 12'

- 1/4" sheets            1/2" sheets
- 3/4" sheets           3/8" sheets
- 5/8" sheets           1" sheets
- 7/16" sheets

First 75 miles of delivery are free.

**Write or call:**

**Hoyt Tidwell**

931-629-4869

2058 Tennessee St

Westpoint, TN 38486

**FLOORING SALE**

<i>3/4" Thick Solid Hardwood Unfinished T&amp;G:</i>		Per Sq/Ft
<b>5" Red Oak Super Rustic (shorts) Full Skids only</b>		<b>\$0.95</b>
<b>2-1/4" (choice) Red or White Oak Cabin Grade (nice quality)</b>		<b>\$1.00</b>
<b>2-1/4" Red Oak #2 Common (shorts) (Like Cabin Grade)</b>		<b>\$1.08</b>
<b>4" / 5" Red Oak #2 Common (character)</b>		<b>\$1.15</b>
<b>2-1/4" Red Oak #2 Common (nice quality)</b>		<b>\$1.60</b>
<b>3-1/4" Red or White Oak (also have 5" White Oak Cabin Grade \$1.15)</b>		<b>\$1.10</b>
<b>2-1/4" #2 Common White Oak</b>		<b>\$1.50</b>
<b>3-1/4" #2 Common White Oak</b>		<b>\$1.60</b>
<b>2-1/4" Cabin Grade Maple</b>		<b>\$1.35</b>
<b>2-1/4" Red Oak #1 Common</b>		<b>\$2.30</b>
<b>3-1/4" Red Oak Select &amp; Better</b>		<b>\$2.99</b>
<i>Prefinished T&amp;G:</i>		
<b>5-1/8" New Heart Natural Pine</b>		<b>\$2.10</b>
<b>2-1/4" Natural Solid Hickory - First Quality</b>		<b>\$2.50</b>
<b>3-1/4" Natural Solid Hickory - First Quality</b>		<b>\$2.99</b>
<b>2-1/4" Solid Hickory - Saddle Color - Pro Series (nice brown color)</b>		<b>\$2.89</b>
<b>4" Natural Solid Red Oak - Cabin Grade (long lengths) (also have 5" @ \$2.99)</b>		<b>\$2.75</b>
<b>5" Provencial Hickory Hand Sculpted - Cabin Grade (nice brown color)</b>		<b>\$2.99</b>
<b>Happy Feet Vinyl Loose Lay Flooring 22mil wear layer</b>		<b>\$3.35</b>
Easy to install with <b>no adhesive</b> or locking system, 100% waterproof, and very durable. Great for basements, concrete, or subfloors. Buy 1,440 sq. ft. or more and save 14¢ per sq. ft. on your entire order.		
<i>Other:</i>		
<b>1x10 Standard Grade Ship Lap Eastern White Pine</b>		<b>\$0.90 ln/ft</b>
<b>1x10 Industrial Grade Ship Lap Eastern White Pine</b>		<b>\$0.57 ln/ft</b>
<b>1x4x16 White Pine Furring Strips/Trim Boards (premium)</b>		<b>\$5.50</b>
<b>5/8" 4x8 Deco Grade T1-11 8" O.C.</b>		<b>\$28.00</b>
<b>1.5" 4x8 EPS Foil Back Insulation (1/2" up to 3" in-stock)</b>		<b>\$16.00</b>

**Shipping Available! Truckloads Available!**



12149 Gower Road \* Glenford, OH 43739  
 Phone: (740) 659-1480  
 Fax: (740) 659-1481

Call us today for more pricing info and to explore our wide range of flooring & lumber options in stock!

**Secondary Metal Ag Panel** for roofing/siding, some minimal defects, cut to length. Reasonable delivery available. Call about availability on colors: Black, charcoal, burnished slate, brown, rustic red, gallery blue, white, dark green, \$1.95/lin.ft. plus tax. Galvalume \$1.75/lin.ft. Lavern Chupp 20500 NW 2200 Rd Garnett, KS 66032, 785-433-1538

**KILN DRIED WHITE PINE SIDING**

Specializing in Tongue and Groove stocking 6", 8", & 10" widths. Rustic Cabin Grade - Standard Grade - Premium Grade Trim Boards in stock. Other profiles available by special order. Order a full truckload and save on freight.



**BUSINESS OPPORTUNITIES**

**Dealers Wanted! Sell Factory Second** Mattresses. New in Plastic. Name Brand. All sizes. Call for more info. Schlabach Mattress 330 E County Rd 600 N Tuscola, IL 61953, 217-543-3493

**CARRIAGES**

**3-seated STB size black poly** wagon w/hydraulic brakes. Good condition, \$3,700.00 OBO. 10479 Ava Rd Ava, IL 62907, 618-571-3443

**Signature cart, like new. Air ride** suspension, with lights and steel wheels, bench or single seat option. \$3,000.00 OBO. Henry King 1316 Anderson Rd Pembroke, KY 42266, 270-889-3977, 7-7:30pm Eastern time

CLASSIFIEDS

### CARRIAGES CONTINUED

**Plastic Delaware style buggies, Kits** or complete. Hardy Carriages 51205 864th Rd Orchard, NE 68764, 402-929-1538

### CLOTHING/DRY GOODS

**Enjoy summer with Crocs** or lightweight shoes. Call for FREE catalog! Creekside Shoe Store 370 Newport Road Ronks, PA 17572, 717-368-2218

### CONSTRUCTION EQUIP

**Durable Reliable Posthole augers 9", 12", 15", 18"** in stock. Also offer custom sizes, attachments in stock. Don't wait, Call today! 2666 Beltz Rd Sardinia, OH 45171, 937-446-0121

### REMINDER: BE AWARE OF SCAMS

Be aware of whom you are buying and/or selling to. Beware of scammers offering to sell your merchandise online for a commission Fee. If you are unsure ask for references and/or a website for verification..  
Busy Beaver Publications  
PO Box 3  
Charm, OH 44617

**717-615-5051**



2022 HANGCHA CPCD70 15,500 LB CAP DEUTZ DIESEL, 3 STAGE, SIDE SHIFT & FORKPOSITIONER , DAUL FRONT TIRES ONLY 329 HRS. \$35,500.

**717-615-5051**



2023 HANGCHA CPCD60 13,500 LB CAP DEUTZ DIESEL, CAB, HEAT & AC, SIDE SHIFT & FORKPOSITIONER 72" FORKS, DUAL FRONT TIRES. ONLY 1146 HRS. \$28,500.

### FARM RELATED

**Open 4X4 Loader Tractors**   
Farmall 40c \$18,900.00. JD 3025E \$17,500.00. Kubota M5400, 1,500 hours, \$17,500.00. 116 HP JD 24 SPEED! \$37,500.00. 6115R suspension \$59,900.00. More!! Glendon Hertzler 37137 Rte 35 N Richfield, PA 17086, 717-314-4974



6' x 10' E-Z Trail Wagon w/adaptor & shalfts. \$1,800 (OBO) Very good condition. 217-254-7294

**Are mice getting into your feed bags?** We have high quality, Poly horse feed and dog food carts that will last a long time. Also, tack boxes and farrier carts. Keystone Sales 332 Hollow Rd Quarryville, PA 17566, 717-715-3498

**CDI Cleaners for all your** cleaning needs. Buggies, Laundry, Kennels, Equipment, and so much more. Biodegradable and Eco-friendly cleaners for all your cleaning needs. Very effective! Keystone Sales 332 Hollow Rd Quarryville, PA 17566, 717-715-3498

**NH 354 grinder mixer, hyd.** drive scales available, long auger \$5500. NH 358 long auger \$13,500. Parting out NH, Gehl grinders. Scale sets and parts for all grinders. New windows and seals for NH windows. 3000 gallon diesel tank, \$1500. 301-992-3526

# Horse Corral

**HORSE CORRAL ADVERTISING FORM**

1. Name: \_\_\_\_\_
2. Billing Address: \_\_\_\_\_  
\_\_\_\_\_
3. Ad Phone Number: \_\_\_\_\_
4. Photo! 
5. Selling Price: \_\_\_\_\_
6. 12 Word Description: \_\_\_\_\_  
\_\_\_\_\_
7. What Regions? (Circle: PA, OH, MI, NY, TK \$80 = 1st, \$60 = Add'l)
8.  Send me an Invoice  
 Call me for Credit Card

\* Publication Date is Two Weeks After Thursday Deadline.

Contact: **330.201.9582**  
for details  
horsecorral@busybeaverpublications.com

**Horse Corral**  
8065 Twp Rd 652  
Millersburg, OH 44654

\$19,000



3 y/o Stud Mohegan Hanover/ Hard Rock-N-Roll/ Keystone Nordic. Very athletic proven. TSS. 518.384.5329

**Get a headstart on your** algae problems. Check out our selection of windmill aeration units, pond dye and more. Will ship. Miller Truss and Lumber 27547 Timber Ave Pulaski, IA 52584

**Howard 10ft rototiller & power** cart to run it, complete setup, nice, field ready. NH 790 Forage harvester, with Deutz engine, hay & corn head, field ready. Daniel Hostetler W548 Co Rd Q Saint Cloud, WI 53079, 920-898-4611

**NH 273 Baler, field ready.** \$2,500.00. JD 336 Baler, field ready. \$5,200.00. NH 311 Baler, excel. condition. \$8,900.00. NH 68 Baler, field ready. \$1,400.00. 4Star ztedder, good condition \$5,500.00. NH 488 Haybine, works. \$3,200.00. NH 258 Rake, field ready. \$2,800.00. 3pt 2 bottom plow, good condition. \$450.00. We do farm equipment repairs. Pickup and delivery available. Pleasant Hill Repair 4930 Lucas Perrysville Rd Perrysville, OH 44864, 330-521-4906

**“Sea-90 Trace Mineral Salt” Naturally** solar dried, ocean trace mineral salt containing a balanced mineral, biological, and trace element profile not found anywhere else in the world. Higher levels of minerals, lower sodium, and lower Iron levels compared to other mineral salts. Available as a mineral salt for all livestock, Ag salt with humates for soil, and foliar salt for all crops. Available at your local Agri-Tonic Dealer. Oregon Ag LLC 1150 E Oregon Rd Lititz, PA 17543, 717-656-0067

**HAY/STRAW/FEED**

**#1 Organic Certified Top Quality** Hay & Balage! Nationwide Delivery! Volume Discounts! Call to listen to the RECORDED UPDATES on availability & pricing! Buckeye Hay Co. 33656 Co Rd 126 Millersburg, OH 44654, 330-556-8221

**HEALTH/NATURALS**

**A Very Effective Way to** get rid of your aches and pains without those weekly trips to the chiropractor. The Rapid Release Massager is AMAZING! Keystone Sales 332 Hollow Rd Quarryville, PA 17566, 717-715-3498

**THE HEALTH CORE**

**A natural plant-based supplement program**



**Our powerful, top quality products are derived from real living plants on earth and sea.**

Are you looking for a good “maintenance” program to keep your immune system strong and healthy?? Or maybe you are searching for the right tools to heal your body from chronic issues. Don’t give up yet! **TRY TRANONT.** We have **REAL** testimonies from real people just like you.

**Ready to get started?**

1-5 bottles \$64  
or  
Pre-paid orders of 6 or more  
\$62 a bottle w/free shipping

**J & S Herbs**

**4004 E Newport Rd  
Gordonville, PA 17529**

**717-917-8208 - 8:10am-8:30am (ET)**



**AWESOME SPECIALS ON PHIX!!** Listen to this recording, 605-313-9878, code 6785553#. Lots of success stories. Call for Monthly Giveaways. Sarah Fisher PO Box 14 Madisonburg, PA 16852, 814-349-4849

**BODY BALANCE 8qts-\$234.00.** **OSTEOPRO CARE 4qts-\$185.00.** FREE SHIPPING. Miriam Ruhl, 1143 Briarwood Ln, Mount Joy, PA 17552. 717-653-4416

**DNA test can help you** uncover the reason for health issues that have plagued you for yrs. like chronic fatigue, constant rashes. Also, after the test comes back, you get access to a customized supplement - created for you according to the test results! Call or write for more info. Elevate Nutrition 7814 PA-147 Sunbury, PA 17801, 570-917-4884

**COLON/GUT/ PARASITES/ DIGESTIVE ISSUES??** After having parasites, trying all-natural products for 12 solid years, then having bowel obstruction, discovered being filled w/parasites--organs looking like Swiss Cheese. Ask for full story! Our Colon/Parasite Cleanse designed to open parasite nests and destroy them! Include Ningxia Red & get 2mo Supply for only \$355.00. Free Shipping. Don’t wait until it’s Too Late!!! Stephan Miller S4775 E Newburn Ave Hillsboro, WI 54634, or call Lena Wengerd, 269-721-3827

**Do you struggle with your** weight? Kill food noise with curbix! Also boosts your metabolism & helps to regulate blood sugar . . . call or write for more info or with any questions. Elevate Nutrition 7814 PA-147 Sunbury, PA 17801, 570-917-4884

## HEALTH/NATURALS CONTINUED

**DoTERRA PRODUCTS AT WHOLESALE PRICES!** New customer specials: 20% off \$250 orders, plus FREE 10ml Breathe, 15ml Citrus Bliss, Diffuser, and FREE shipping. Scenic Ridge Accents W8420 Rock Creek Rd Willard, WI 54493, 715-267-6493

**EHT All Natural Brain Food!** Great results with depression, bi-polar, insomnia, sleep disorders, Parkinsons, focus/brain fog, brain injury, bed wetting, children's IQ levels, ADD. 30 capsules, 1 month supply. \$59.95. Buy 4+ free shipping. In USA. Melvin Herschberger 65000 Meeksville Rd McArthur, OH 45651

**For all your healthcare needs,** call Valley View Health Clinic. 330-897-3232



**THE Blooming THISTLE**  
Berlin, OH  
330-403-3277

**EarthCup Creamer Is A Healthy Option that Mixes Easily With:**

- ✓ Coffee
- ✓ Tea
- ✓ Hot Chocolate

## BENEFITS OF Cell-Link

90 ct. \$42 360 ct. \$126

Restores mineral  
balance for bone health

Supports joints &  
reduces  
inflammation

Aids in healing  
broken bones,  
bone spurs, gout  
& arteriosclerosis

**15 Years**  
Elite Nutrition  
All Natural Supplements  
812-636-5055



*Natural Ingredients for  
Results you can feel!*



**REBUILD.  
RESTORE.  
DOMINATE.**

**Ever wake up feeling groggy,** or struggle with heartburn, sugar cravings, constipation, bloating, or mentally exhausted? It begins with GUT HEALTH! The gut health triad is designed give you the digestion you long for . . . Find out how it feels to feel good! Call or write: Elevate Nutrition 7814 PA-147 Sunbury, PA 17801, 570-917-4884

**Have Cavities? Tired OF Dentists?** New testimonies are coming in! (Amazing, we could just watch those cavities fade away! Grateful!- PA) Help infections, toothaches, cavities, and gum diseases. Try this Tooth Care pack for only \$171.50 plus tax and shipping. To increase chances of healing, add liquid minerals for \$33.75. Call for more info Rachel Nissley 989-802-9502

**Have problems with psoriasis or other skin rashes?** Try gelmicin creme. May special buy 3 get the 4th half price. 260-413-8939 x1

**Herbal extracts, herbal calcium, kidney/bladder,** throat & tonsil, super tonic, slippery elm, nerve calm, 4 oz \$14, 8 oz \$26.50, 16 oz \$42. Intestinal formula #1 \$16, super 5 \$26, sinus & allergy \$16.50, herbal mectin, complete wormer \$21, salves & more. Free catalog available. Pine Ridge Herbs 77 Pine Ridge Drive Port Royal, PA 17082, 717-527-9909

**HIP PAIN? KNEE PAIN? keeping** you up at night? What if you could avoid a hip or knee replacement with the proper nutritional supplement? What if you could feel the difference in as little as one month? It has happened over and over! Feel Better Fast! FREE information and FREE shipping! Midwest Solutions 260-627-5681

**LIFEWAVE: ACTIVATE your own stem** cells naturally. The lifewave patches activate the GHK-CU copper peptide which activates your own stem cells, so you start healing from the inside out. More information call Sharlene 816-686-4508

**Loaded T delivers smooth sustained** energy with every delicious dip. Say goodbye to coffee jitters and say hello to all day glow without all the extra sugar. The flavors are amazing! Effective weight loss. Convenient, especially when using the shakes with it. Also great to promote focus and concentration. Call or write for free catalog 1285 Maxey Knob Rd Canmer, KY 42722, 270-218-3715

**Mama Bear & Kirkland Diapers,** Free Shipping to your Door. Kirkland 1&2-\$35.00, Mama Bear-\$47.00. Both Brands, szs: 3-6-\$57.00. Wipes-\$27.00, Pullups-\$50.00. Kim Thomas 409 Creek Road Christiana, PA 17509, 610-780-8773

**THE Blooming THISTLE**  
Berlin, OH  
330-403-3277

Enjoy Every Morning  
With A Healthy Cup of  
Moringa Hot Chocolate

**Ivermectin tablets 12 mg (for humans!)** \$75 for 100. 18x48 pool, NEW! \$495. Silent Scott reel mower, make offer. 717-284-1022

**Men, no more nighttime trips** to the bathroom. People are having amazing results without meds or pills! Will send info. 330-317-8084

**Neurogen Brain Balancing now open** on Mondays, located at 12305 Palmyra Rd Oak Grove, KY 42262 Appointment only. Call Sonia Sears 714-222-8011

★ **Ningxia Red 8 bottles \$268.20!** Free shipping. \$20 refund! Free gifts, free samples! Try Inner Beauty collagen. Proven to thicken hair/strengthen nails! The Martin's 549 Milheim Rd Watsonstown, PA 17777, 570-464-1054 VM

**No more heartburn or acid** reflux after a cup of coffee, rather feel energized and alert and ready to tackle what's ahead-with RED COFFEE. 100% organic, low acid, infrared roasted, and coffee berry infused. Call or write to: Elevate Nutrition 7814 PA-147 Sunbury, PA 17801, 570-917-4884. Wholesale inquires welcome!

**PRECIOUS TOTS DIAPERS AND SERENE COMFORT SANITARY NAPKINS!** All products are natural, very absorbent, super soft, and TOXIN FREE! Diaper: \$48.00/case, plus shipping. Auto-ship saves \$2.00/order. 4 packs/case, sizes 1-5. NAPKINS: \$5/pack, 10 or more, free shipping, 10% case discount. (48) Sizes Xsmall- Xlarge. KY residents add 6% tax. Cash or Check. WHOLESALE AVAILABLE. T&L Enterprises 2903 Logsdon Valley Rd Munfordville, KY 42765, 270-218-8320. F. 270-514-5715. tlenterprises@YCmail.net



**LION'S MANE (60 CAPSULES)**  
\$34.50 +  
Shipping cost \$9

- Premium Lion's Mane Mushrooms.**
- US Grown in the Appalachian Mountains
  - 100% Fruiting Bodies
  - NO Filler's
  - NO Heavy Metals (Third party Tested)
  - Small, easy to swallow capsule

**Pure Path Distribution LLC**  
P.O. Box 151  
Emmitsburg, MD 21727  
1-888-401-7747



## HEALTH/NATURALS CONTINUED

**Reign Napkin Give Away** ★100 packs FREE!! Once a year customer appreciation. 3 winners total. To enter your name into drawing: Order 20 packs Reign napkins (Mix and match kinds) your name gets entered once and get 2 free packs. Order 60 packs, get 7 free, enter name 3 times. 100 packs+ 15 free, enter 5 times! Price per pack \$6. No tax, free shipping. All order is by June 30th, drawing will be July 1st. Call or write with your order. We also have Serene napkins available at 4-pack or 1 case (48 packs) \$180.00. Free shipping. Precious tots diapers, available by case. \$49.80 plus shipping. 1 case at \$10.00, 2 at \$18.00, 3 at \$25.00, 4 at \$30.00. Wholesale available on all products. Katie King 822 May Post Office Rd Strasburg, PA 17579, 717-687-8477

**REIGN NAPKINS. Save big! \$6** per pack. Free shipping on 25+packs. Mix or match. Plus tax where required. Free tax in IA, IL, MN, ID, NE, CO,MO. Buy 25 packs, get 5 free. 50-(12 free).80-(20 free). All orders must be prepaid. Emma Herschberger 65000 Meeksville Rd McArthur, OH 45651

**Reign Sanitary Napkins \$6.00/each package.** Free shipping on any order. Sales tax may apply. Free info &

samples. New customers welcome! Call or write, Martha Hochstetler, 60026 Nottawa Rd, Centerville, MI 49032. 269-467-4034

**SHAKLEE/MODERE: ask about free gift,** shipping, and distributor price. Independent Distributor. C&A Sales LLC. 5488 Township Rd 401 Millersburg, OH 44654, 330-893-7515

**Showtime 1gal/\$65.00, 5gal/\$255.00,** four 1 gallons/\$220.00, shipped. Add 7% tax in Ohio. Cephas Miller, 5488 Township Rd 401 Millersburg, OH 44654. 330-893-7515

**We've all been there: it's 2:00 PM,** the "brain fog" is rolling in, and the siren song of a third espresso or a sugary snack becomes impossible to ignore. For decades, caffeine and refined sugar have been the go-to fuel for the modern worker. But while they offer a quick spark, they usually leave us with a jittery heart and an inevitable "crash" that leaves us more depleted than before. If you're looking for a sustainable way to sharpen your focus without the roller coaster, Midday Focus Greens might just be the upgrade your brain has been waiting for. True mental clarity isn't about forcing your brain to work harder through stimulants; it's about giving it the raw materials it needs to perform at its best. By trading the temporary "buzz" of sugar for the deep, nutritional support

of greens, you're not just clearing the fog--you're building a more resilient mind. Midday Focus Greens \$51.87. (Includes tax and shipping.) Buy 2 or more for a 10% discount. Call or write NuLife today to place your order. NuLife Communities 1390 Co Rd 600 Baltic, OH 43804, 330-845-4004

**Weight Loss! Are you struggling** with weight management? GLP-1 weekly injections are extremely effective for weight management. Most people lose 15-30 lbs in 8 weeks or less. Call or text for more info. Call after 12pm. 814-547-2177

★**Will do mail orders for** vitamins etc. Now, Chupps, Trace Minerals and lots more. Send stamped envelope for price list. County Line Herbs & Variety 27939 Palmer Rd Edwards, MO 65326

**Would like to try Redox Cell Signaling Supplement** for your Health. Are you Desperate for help with your Health, and that Dreaded Health issues. There is Hope give this Product a try, 10% below wholesale, use ID# 1800820313 Kathy 561-346-7152

**Young Living special through May!** Buy this bundle: 4 bottles Ningxia Red for \$134.10. Receive free shipping, monthly newsletters, a free account w/ Y.L., plus be entered in a drawing to win 2 bottles free. BarbiEda King, 717-803-1102. Melvin King, 484-796-1923

## HOUSEHOLD/FURNITURE

**Brand New water Heaters 1yr warranty** \$449.00 Air conditioners in stock! Many Appliances in scratch and Dent in stock. 1yr Warranty, Everything New! Located In southern Ohio. R&G Sales 10144 US-68 Georgetown, OH 45121, 937-690-6006

**Lifetime and KitchenCraft Cookware.** Made in West Bend, Wisconsin since 1909. Waterless, greaseless cookware that has withstood the test of time. Need knobs and handles? Call for all your cookware needs. Book a supper and receive a free gift! Vernon Weaver Jr. 11431 CR 10 Middlebury, IN 46540 574-238-2687



### LION'S MANE (60 CAPSULES)

\$34.50 +  
Shipping cost \$9

**Pure Path Distribution LLC**  
P.O. Box 151  
Emmitsburg, MD 21727  
1-888-401-7747

#### Premium Lion's Mane Mushrooms.

- US Grown in the Appalachian Mountains
- 100% Fruiting Bodies
- NO Filler's
- NO Heavy Metals (Third party Tested)
- Small, easy to swallow capsule



# Insulated Thermo Bag

**NEW**



**Designed with convenient carry handles!**

- closes with zipper
- pouch on front
- dimensions 8"H x 15"D x 19"W
- keeps hot 5+ hours



### Thermo Bag Order Form

Name \_\_\_\_\_  
 Address \_\_\_\_\_  
 City, ST, Zip \_\_\_\_\_

	Qty	Price	Total
Burgandy	_____	\$89	_____
Black	_____	\$89	_____
Charcoal	_____	\$89	_____
		Tax	_____
		Shipping	\$14.00
		Total	_____

Mail order and check to: Mound Country Store



**ORDER  
 YOURS  
 TODAY!**

**Mound  
 Country Store**

30315 County Road 12 | Fresno, OH 43824

**740-502-9623**

**CDI Cleaners for all your** cleaning needs. Buggies, Laundry, Kennels, Equipment, and so much more. Biodegradable and Eco-friendly cleaners for all your cleaning needs. Very effective! Keystone Sales 332 Hollow Rd Quarryville, PA 17566, 717-715-3498

**Crib with drop sides, good cond.** \$75. One other crib \$50. Chest of drawers, good cond. \$75. Single bed with boxspring and mattress, \$50. Cherry serving "maud" with big wheels, good cond. \$75 obo. 1 buy Coleman lanterns. Bird-in-Hand, PA 717-661-5936 x1

**For Sale: Dew/Mil meat grinder** for \$1000.00 New price \$1440.00 Dew/Mil Vacuum sealer for \$100.00 New price \$329.00 Both were only used once. Dewalt Diffuser for \$5.00, Dew/Mil Massager for \$30.00 Contact: 618-835-4469

**Hand cream separators in stock.** They are slightly used but rebuilt with American made parts and are good as new. 1 year warranty. 1 gal. milk bowl, capacity 18gal per hour. \$360.00. FREE SHIPPING. Rolling Acres Housewares 33434 Township Rd 231 Baltic, OH 43804, 330-204-3523

**New Schwartz oil stoves in stock.** Ready to ship. 1 burner vat Effly open style. \$425. 1 burner vat Effly enclosed. \$475. Shipping \$30. 2 burner tabletop Effly. \$665. Shipping \$50. 2 burner oil stove. \$900. shipping \$75. 3 burner \$1050. Shipping \$100. 4 burner \$1295. Shipping \$150. 5 burner oven on top. \$2595. Truck freight. All stoves are in black. Rebuilt New Perfection 5 burner tabletop and oven on top stoves in stock. \$1,650. Full line of replacement parts in stock. Troyer's Repair 7655 State Route 241 Millersburg, OH 44654

## LAWN & GARDEN

**Bradley Mowers. User friendly mowing** for women and kids! Fully hydrostat, 25 hp electric start engine, loop handle steering. Optional accessories- cloth bagger, lawn striper, stand-on sulky. 48"-\$4800, 52"-\$5000, 60"-\$5700. Fast Shipping! Falcon Engine, 574-642-4353

## USED EXMARK Stand on MOWERS

60" 2019 models.

Fully serviced and repaired.



**\$3500.00**

County Line  
 Engine  
 260-593-2792

Pellets **"Chicken Manure"** Lower Prices Organic

### Pelletized Poultry Manure

No Toxins, No Weed Seeds,  
 Less Odor, 4-3-2  
 Pastures, Hay, Alfalfa,  
 Gardens, and Lawns

### Custom Blends

Slow Release - Very Affective

### Hoosier Organic LLC

Neil: 805-342-8428  
 Terry: 812-444-9071



**WHISKEY BARREL TABLES  
 BARREL SHELVES  
 BARREL COFFEE BAR  
 UNIQUE DECOR**

**Call For A Catalog!**

Call for pricing:  
 Ph. 260-214-5125 • Fax 260-214-5126  
 — DEALER INQUIRIES WELCOME —

## Countryside Milwaukee Tools MULTIPLE TOOL DISCOUNT

**M18 FUEL** DRIVEN TO OUTPERFORM

**21" MOWER**  
 Baretool \$450

**\$950** Kit w/Forge Battery

**\$850** Kit

**FREE SHIPPING!**

**812-621-1913**  
 4799 W.C.R. 600 S, Holton, IN 47023

## LAWN & GARDEN CONTINUED

**Dutch soil concentrate 100% naturally** designed for soil, seed plants, and a stronger root system. Increase yields, sweeter veggies and fruits. Works great for grass-fed famers. Increase growth and yields on hay and corn. Pint \$18.00 shipping \$8.00. Quart \$29.50 shipping \$8.50. Gallon \$86.00 shipping \$12.00. OH residents add 6.75% sales tax. Schla-bach Supplies, 8908 Barrs Mills Rd. NW, Sugarcreek, OH 44681. 330-897-0150

## MAPLE/MAPLE SUPPLIES

**FOR SALE Gas powered reverse osmosis** model 625, made by Deer Run Maple, mounted on 12in air tires, \$5,000.00 OBO. Mark Beiler 362 NY-28 Richfield Springs, NY 13439, 315-858-0692

**Pure Michigan maple syrup, available** in 5 gal. buckets or 55 gal. drums. 5 gal. pail \$35 per gal. 55 gal. drum. \$32 per gal. John Troyer 1877 N Ocqueoc Rd Millersburg, MI 49759

## MISCELLANEOUS

**New or used portable, wired or wireless, PA systems.** Call for info. All Points Sound Co. check us out on the Web. 717-222-6191.

### The Original Phone Number Keeper

Economy holds 960 Contacts  
Regular holds 1500 Contacts  
Vendor Requests Welcome



To Order:

**Marty & Laura Miller**  
8290 SR 753 South  
Greenfield, OH 45123  
v/m (937) 820-1651

**2-3 phase condensing units.** 2- 1 phase cooling units. 1 used 5 years, everything works. 46" wide cooler panels. 26-14ft. 12-17ft. 3 doors w/latches. 10ft. high galv. beams, post, rail. 12 heavy duty switches. Alvin Yoder 8077 Buss Rd Apple Creek, OH 44606

**!!! Amtrak timetables, (Updated), train calendars!!!** Maps, Atlases, Globes, School maps. Ask for FREE catalog! Crossroad Map Sales 41 W Eby Rd Leola, PA 17540, 717-478-7013

### Pet Food & Treats (Dog, Cat, Chicken)

Toilet Paper  
Paper Towels  
Energy Drinks  
Aerosols

bug spray, window,  
auto cleaner, lubricate

Organic Foods  
Banana Boxes

FTL or Pallets 6 plt min  
Cheese, Frozen Foods

### Bargainmax, Inc

704-612-9794 Sales

704-277-8007 Doug

Items above can be in/out/Sht Dted

**"First Strike Rat/Mice Bait,"** Use for the toughest rat/mice bait situations. Very high acceptance even when competing food sources are available. Child and pet safe bait stations also available. Available at your local Agri-Tonic Dealer. Oregon Ag LLC 1150 E Oregon Rd Lititz, PA 17543, 717-656-0067

**Used slip board 1x6x12ft oak** boards and 3x6inx7ft locust posts, 3,000+ft, make offer. 717-679-3109

## PRODUCE/EDIBLES

**A2A2, grassfed, all natural dairy** products! Rich yellow spring butter 1 lb containers, \$9.50 lb. 45 lb block, \$8.50 lb. Colby cheese \$5 lb. #2 Colby \$2 lb. #2 Monterey Jack \$2.50 lb. We ship UPS! Chilly Creek Farm 409 Ants Hill Rd Bloomsburg, PA 17815

## OFFICE SUPPLIES/ PUBLICATIONS

### introducing School Desks

Use for home schooling or in schoolhouse.

Adjustable school desks made from solid hardwood with Dovetailed Box Corners

Write or fax for details.



TIMBERSIDE WOODWORKING

2853 County Road 200 | Dundee, OH 44624

FAX (330) 698-3200

## PRODUCE EQUIP/ SUPPLIES

**"Bio Char,"** Improve soil structure, better moisture holding capacity, increase microbial activity, higher quality produce, less diseases and insects. Great for corn, alfalfa, produce, gardens. Competitive prices. Available in bags or totes at your local Agri-Tonic Dealer. Oregon Ag LLC 1150 E Oregon Rd Lititz, PA 17543, 717-656-0067

## REAL ESTATE (FOR SALE)

**For sale, 58 acres with 2 houses,** barn, polebarn, sawmill, and some more outbuildings. Great location, only 9 miles away from shopping center and on a main road for any type of business. Contact Mahlon Schlabach 6831 Northland Dr Stanwood, MI 49346

**For Sale: 90+/- acre farm** just outside the city limits of Edmonton, KY in Metcalfe County. Barn, shop, shed, partial fencing, and 2 ponds. Great for livestock, or to subdivide. Great place to build. Plenty of room for Multi-family. Jeremy Goodman RE/MAX Highland Realty and Auction. 270-590-9052

# DO YOU WANT TO MAKE MONEY FROM YOUR WOODLOT?

**MARK YOUR CALENDARS FOR THE SMALL SCALE FORESTRY EXPO!**  
 \$10 Parking per Car/Truck Load



**SMALL SCALE FORESTRY EXPO**



**SEE COMPANIES SUCH AS:**  
 Tajfun Firewood Processing Eq  
 Wood-Mizer  
 Logosol  
 Turbo Sawmill  
 Hud-son Forestry Products  
 Morbark  
 Norwood Portable Sawmills  
 and MORE!!

Contact Bruce Button • 518-221-4103

**SEPTEMBER 18-19 • 2026**  
 Friday & Saturday 9-5 • Bland County Fairgrounds • Bland, VA

[www.smallscaleforestry.com](http://www.smallscaleforestry.com)

CLASSIFIEDS

## SAWMILL EQUIPMENT

**5 head older heavy duty** Brewco resaw, 36" wheels, 20hp electric motors on each head, includes hydraulic pack and spacers \$35,000.00 delivered. Sunset Lumber 6117 Menchalville Rd Reedsville, WI 54230, 920-905-4938

**Diamond and CBN Grinding wheel** recoating. We resurface worn Wood-mizer, and all brand stones in Michigan USA since 1985, with Virgin Diamond and CBN. Call 248-280-1185. Ship to Dianamic Abrasive Products Inc. 2566 Industrial Row Drive Troy, MI 48084. Discount for first time customers only

**For Sale #362 Timber Buddy** Manual Portable sawmill 35H Vanguard 24' logbed with rools and Mudsaw 12,000.00 Would also consider renting. 2- Hydraulic pumps 4- big Hydraulic Cylinder 2-small Cylinder Off D4D cat \$82J Make Offer. Isaac Stoltzfus 410 Bayhan Lane Waverly, OH 45690

**For Sale grade resaw 16x16** run around all Mechanical 36" wheels located in MN. Gotta go, willing to make a deal. Hillside Machine 14607 350th Street Strawberry Point, IA 52076

## SHOP/TOOLS

**Tent Stake Driver. Powered by** Honda, 3 yr warranty. 3" guide tube \$2170. 2" guide tube \$1675. \$200 off for church use. Falcon Engine, 574-642-4353

**25hp. Yanmar 3TNV76 Powerunit** with stubshaft and control panel (800 hrs)  
**\$2750.00**



717-335-8181

**23hp. Perkins 103-10 powerunit** with stubshaft and autostart panel  
**\$2750.00**



717-335-8181

## For All your Metals, Salvage & Surplus needs



**Aluminum Rounds 6061**  
 1/2" x 96" \$6.00 Per Stick  
 (2# per stick)



610-921-8848  
 Shipping Available



**Stainless Steel Diamond Plate**  
 304 48" x 96" x .125"  
 \$420.00 per Sheet (168# per sheet)



**Aluminum and Steel Fence Sections**  
 Aluminum Fence Sections  
 43" x 72" \$42.00 per section (35 sections available)  
 48" x 72" \$33.00 per section (62 sections available)  
 70" x 72" \$54.00 per section (34 sections available)  
 Steel Fence Sections  
 94" x 84" \$92.00 per section (34 sections available)



**Oldcastle Insulated Block Light Grey**  
 10" x 8" x 16"  
 \$6.00 each (over 2000 available)



**Assorted Rectangular Steel Tube 1/4" & 3/8 wall** \$0.55 per LB (Over 2000' available)



**Stainless Steel Steps with Safety Rail**  
 (Shown) Rise 7-3/4" Run 10-3/4" (15 Steps)  
 \$3.00 per Pound, Steel Steps Assorted Size and Step Count \$65.00 Per Step

## COUNTRYSIDE MILWAUKEE TOOLS



**15oz Stiletto Hammer**  
**\$250.00 Ea**  
 Free Shipping

Also Available in 14oz.

812.621.1913  
 4799 W. CR 600 S. Holton, IN 47023

## SHOP/TOOLS CONTINUED

**50KW GM natural gas genset**, great condition, \$9,500.00. Mitsubishi electric forklift with battery rejuvenator package (eliminates future battery replacement costs). Dynamic Energy 11630 W 450 N Middlebury, IN 46540, 574-642-1256

**Powermatic square Hollow Mortiser w/bits.** \$950.00 OBO. Powermatic 14in tablesaw with Beismeyer fence GC. Miller Maxstar tig-stick welder GC. 330-359-0147

## SERVICES RENDERED

**Travel by train? Will get** Amtrak tickets for You! Can mail, fax, email, or by phone. 7-AM to 5-PM Eastern time. Andy Weaver 15240 Wynncrest St SW Navarre, OH 44662, 740-501-3531

## Are you struggling to shop for products online?

**Simplify Your Shopping:** Call us during business hours with the descriptions of the products you need, confirm your shipping and payment info, and we'll handle the rest. We'll order the products online and have them shipped to your door, saving you precious time!

For inquiries or to place an order,  
Call us at **330.331.2035**



Your Convenient Shopping Solution.

Monday - Thursday 8:00 am - 3:30 pm.  
Friday 8:00 am - 2:00 pm EST  
Closed Saturday & Sunday.

When placing your first order, please have your credit card or checkbook ready. Limitations and convenience charges apply. 10% of online total + \$10.00 / 15 minutes

## SPECIAL EVENTS/ NOTICES

**2026 TOURS: June 29-July 17:** The Northeast Tour: We explore the New England states plus Prince Edward Island and Nova Scotia. Some highlights are a whale watch out of Bar Harbor, Maine, step on guides on PEI and Nova Scotia, Cog Railway on Mt Washington, Ferry to Martha's Vineyard, plus much more. **AUGUST 3-22ND:** Northwest Tour: All the way out to Oregon, Washington, and Northern CA. Yellowstone, Grand Tetons, St. Ignatius, Montana, several Hutterite Communities, whale watch out of Washington, Redwoods, Bar-T Covered Wagon Cookout, plus much more! **SEPT 16-18:** Lancaster, PA! Tour, Sight and Sound--Joshua. We'll have a guided tour of the Old Order Mennonite Community. A meal in an Amish Home with their youth singing to us afterwards. A tour of the Christian Aid Ministries Warehouse to see how volunteers package food, clothing and other necessities for needy countries. Also several stops at Amish Stores and Businesses! **OCT 9-10,** Gallilean Home Trip--We take in their annual auction. Call or write for brochures and to find out more about any of these tours. Swiss Valley Tours P.O. Box 552 Sugarcreek, OH 44681, 330-852-3898

## SPORTING GOODS

**All the new Ravin crossbows** and some custom options in stock, call or write for a Ravin brochure and our special deals 😊 price list. Martin's Archery Pro Shop 305 Troup Valley Rd Mount Pleasant Mills, PA 17853

**ATN Thor LT Series Thermal** scope used but still in good condition \$850.00 OBO 816-661-7816

**Get a headstart on your algae problems.** Check out our selection of windmill aeration units, pond dye and more. Will ship. Miller Truss and Lumber 27547 Timber Ave Pulaski, IA 52584

🚩 **Huge Savings on Trophyline** saddles and packs! Overstock sale going on right now! Call our product info line for details. 330-674-9609 x 25. Get your copy of our 2026 116 page catalog. Call or write. Mobile Hunting Solutions 6652 Co Rd 203 Millersburg, OH 44654, 330-674-9609

## TRANSPORTATION/TAXI

**3500 Dually Pickup 4 passenger w/** gooseneck hookup for long distance hauling (your trailer used). Can also rent a passenger van. Located in Argyle, WI. Matt, 608-482-1409.

## DAVID STOLTZFUS FUND

On Sunday morning, April 19, David Stoltzfus lost his wife and six children (the whole family). David had just arrived at church a ½ mile from his home (wife Sarah stayed home because one of the boys was sick) when suddenly the beautiful Sunday morning was shattered by a loud explosion. Within seconds the whole house was engulfed in flames; the house and everything in it was lost.

**If you would like to help, donations can be made payable to**

**David Stoltzfus Trust Fund**

**and sent to:**

**First National Bank**

**PO Box 444**

**Millheim, PA 16854**

For updates, please call 712-432-5537



# The Busy Beaver Family of Papers



Seven papers with pages and pages of useful advertising delivered to Amish and Mennonite communities all across North America and Canada! WOW!!

## Exposure for your products - Like no other...

With your Ad delivered to  
over 90,000 homes  
**EVERY 7 DAYS!**

Please contact  
**Sales & Marketing Manager**  
**Steven Troyer**  
**330-204-9199**  
ads@busybeaveroh.com

**The Busy Beaver of PA+**  
(Also includes MD, DE, VA, NC & WV)  
PO Box 7930  
Lancaster, PA 17604-7930  
717-568-2380  
ads@pabusybeaver.com  
**Delivered to over 24,000 homes**  
**EVERY 7 DAYS!**

**The Busy Beaver of OHIO**  
P.O. Box 3  
Charm, OH 44617  
330-204-9199  
ads@busybeaveroh.com  
**Delivered to over 23,000 homes**  
**EVERY 7 DAYS!**

**The Busy Beaver of MICHIANA**  
61632 CR 43  
Goshen, IN 46528  
574-501-5105  
ads@busybeavermi.com  
**Delivered to over 17,000 homes**  
**EVERY 7 DAYS!**

**The Busy Beaver of NEW YORK+ and CANADA**  
(Also includes ME & VT)  
Display Ads: 311 Applewood Ln.  
Hilton, NY 14468  
585-441-0083  
ads@busybeaverny.com  
Classified Ads: PO Box 8886  
Lancaster, PA 17604  
**Delivered to over 9,000 homes**  
**EVERY 7 DAYS!**

**The Busy Beaver of TUCKESSEE and BEYOND**  
(Also includes IA, IL, MO, MS, WI, AR, TX, OK, KS, MN, CO, MT, ID, NE, SD & WY)  
Display Ads: PO Box 3046  
Clarksville, TN 37043  
800-886-2704  
bbtuckesse@gmail.com  
Classified Ads: PO Box 3  
Charm, OH 44617  
**Delivered to over 16,000 homes**  
**EVERY 7 DAYS!**

**The Busy Beaver of FLORIDA**  
P.O. Box 3  
Charm, OH 44617  
330-204-9199  
ads@busybeaverfl.com  
**seasonal from October - April**  
**Distribution of 6000 papers weekly**  
**EVERY 7 DAYS!**

**The Busy Beaver EXTREME**  
7828 Township Road 568  
Fredericksburg, OH 44627  
Phone: 800-218-3405  
Fax: 330-470-2240  
ads@busybeaverextreme.com  
**Bi-Weekly publication delivered**  
**to over 85,000 homes**

*\$50.00 subscription rate applies to out of state (USA residents only). For delivery of The Busy Beaver™, please contact the appropriate publication.*

Helping thousands of people to grow their business. **Are you ready to grow yours?**

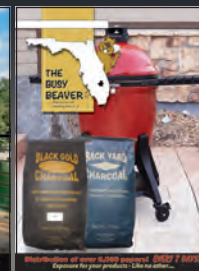
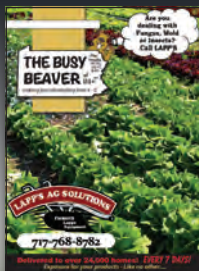

HORSE/TACK/CARRIAGES

# BGMF KENTUCKY GENTLEMAN

TLS Starcraft x Patchwork Simply Amazin by Simply Maserati  
2026 Service Fee \$1,000.00

## FOAL CHALLENGE

### \$5000.00 Prize List:

- 1. \$2000 Cash.
- 2. Free breeding for 2027 and \$500 cash.
- 3. \$500 cash.



Faron & Joanna Lehman | 574.364.0559 | 61362 CR 43 Goshen IN 46528

design by summitpro.net

STANDBRED  
**RICH UNCLE**

CREDIT WINNER X DONATO HANOVER / MUSCLE YANKEE



HORSETACK/CARRIAGES

Photos and Design by Summitpro.net



**Double M**  
FRIESIANS

9811 W 1350 N Nappanee, IN 46550 | 574.773.7797

STANDARD BRED  
**CHOKKA LUK**

NEWTOWN CHOCOLATIER  
X JUSTICE HALL



Photos and Design by Summitpronet

HORSE/TACK/CARRIAGES

**Double M**  
FRIESIANS

9811 W 1350 N Nappanee, IN 46550 | 574.773.7797

STANDBRED  
**THE MAN OF OZ**

OZZY OZZY X OU MAN

Co-Owned by Double M,  
Andrew Miller, Marcus Miller

The perfect choice to continue the breed  
with drive and athleticism!

Photos and Design by Summitpro.net



**Double M**  
FRIESIANS

9811 W 1350 N Nappanee, IN 46550 | 574.773.7797

STANDARD BRED  
**TACTICAL ROCKET**

TACTICAL LANDING X DONATO HANOVER  
Owned by Leroy Kuhns



HORSE/TACK/CARRIAGES

Photos and Design by Summitpro.net



**Double M**  
FRIESIANS

9811 W 1350 N Nappanee, IN 46550 | 574.773.7797

FRIESIAN STANDARDBRED CROSS

# MR LANCE

TORRES G (FRIESIAN) X MR LAVEC



Photos and Design by Summitpro.net

HORSETACK/CARRIAGES

**Double M**  
FRIESIANS

9811 W 1350 N Nappanee, IN 46550 | 574.773.7797

FRIESIAN

# BERNY

JEHANNES 484 X NORBERT 444



Producing **ATHLETIC DRIVING** offspring!  
A perfect choice to sire your next champion!



Photos and Design by Summitpro.net



**Double M**  
FRIESIANS

9811 W 1350 N Nappanee, IN 46550 | 574.773.7797

# MR. TWIST

Homozygous Tobiano - 48" Tall  
2027 bookings are now Available  
Featuring his first 3 offspring

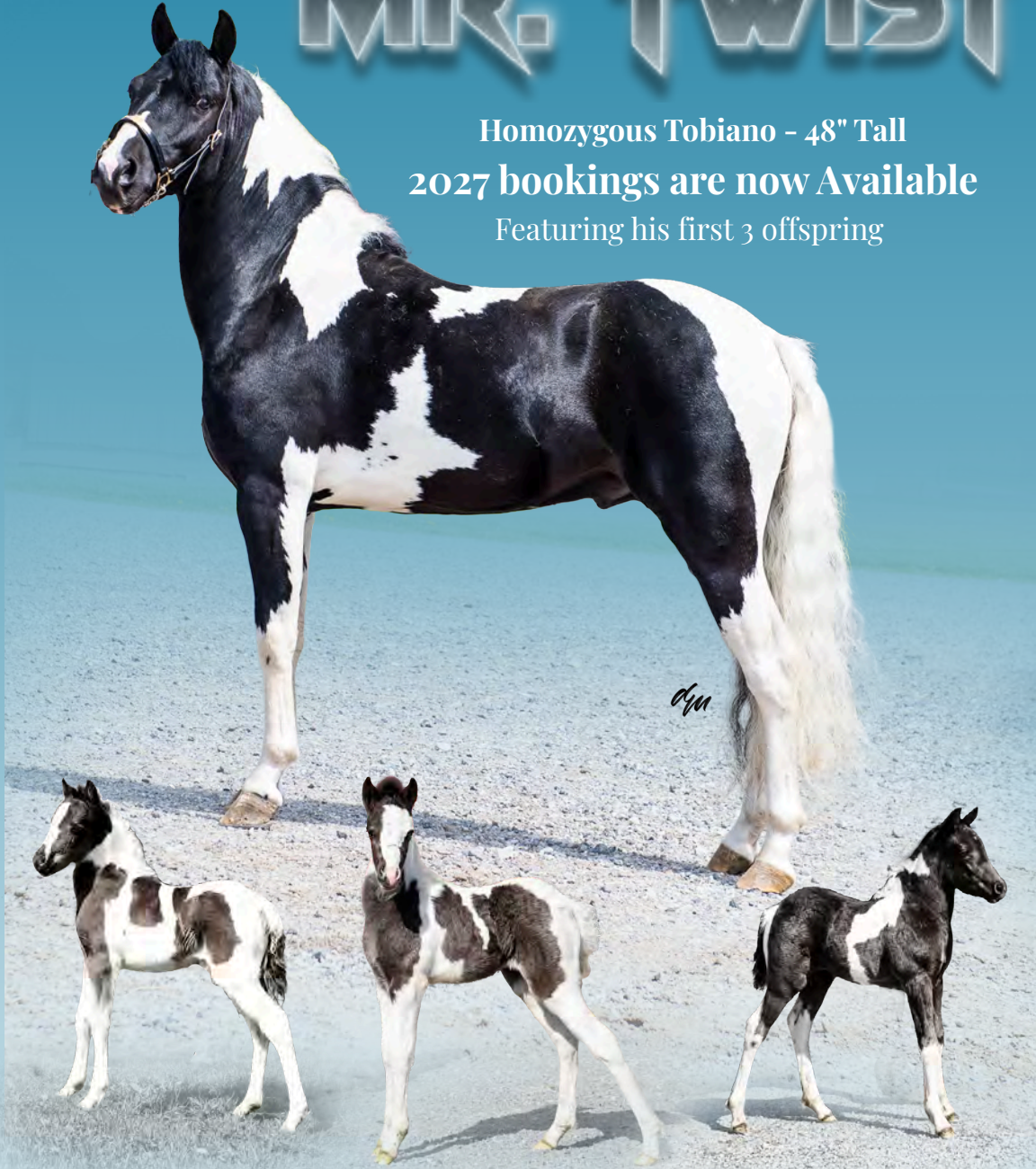

Dam : Paint Pony

Dam : Black Pony

Dam : Black Mare

Thank you to everyone who bred to him in 2026!

He was booked full in 2025 and is once again booked full for 2026

**Double M**  
FRIESIANS

(574)-354-3238

STANDARD BRED

# WINNING HABIT

CONWAY HALL X MUSCLE YANKEE

Co-Owned by Pete King, Steven Zook,  
and JD Petersheim

WOW, What an athlete!

Photos and Design by Summitpro.net



Summit

Double H  
FRIESIANS

9811 W 1350 N Nappanee, IN 46550 | 574.773.7797

STANDBRED  
**MUSCLE HALL**

ANDOVER HALL  
X MUSCLE YANKEE

Owned by Muscle Hall Partnership



Photos by Donna Miller - Design by Summitpro.net



HORSE/TACK/CARRIAGES

**Double M**  
FRIESIANS

9811 W 1350 N Nappanee, IN 46550 | 574.773.7797

2 year old Black & White stallion

# MR EXPRESS

Homozygus tobiano | USPA registered  
limited amount of breedings available

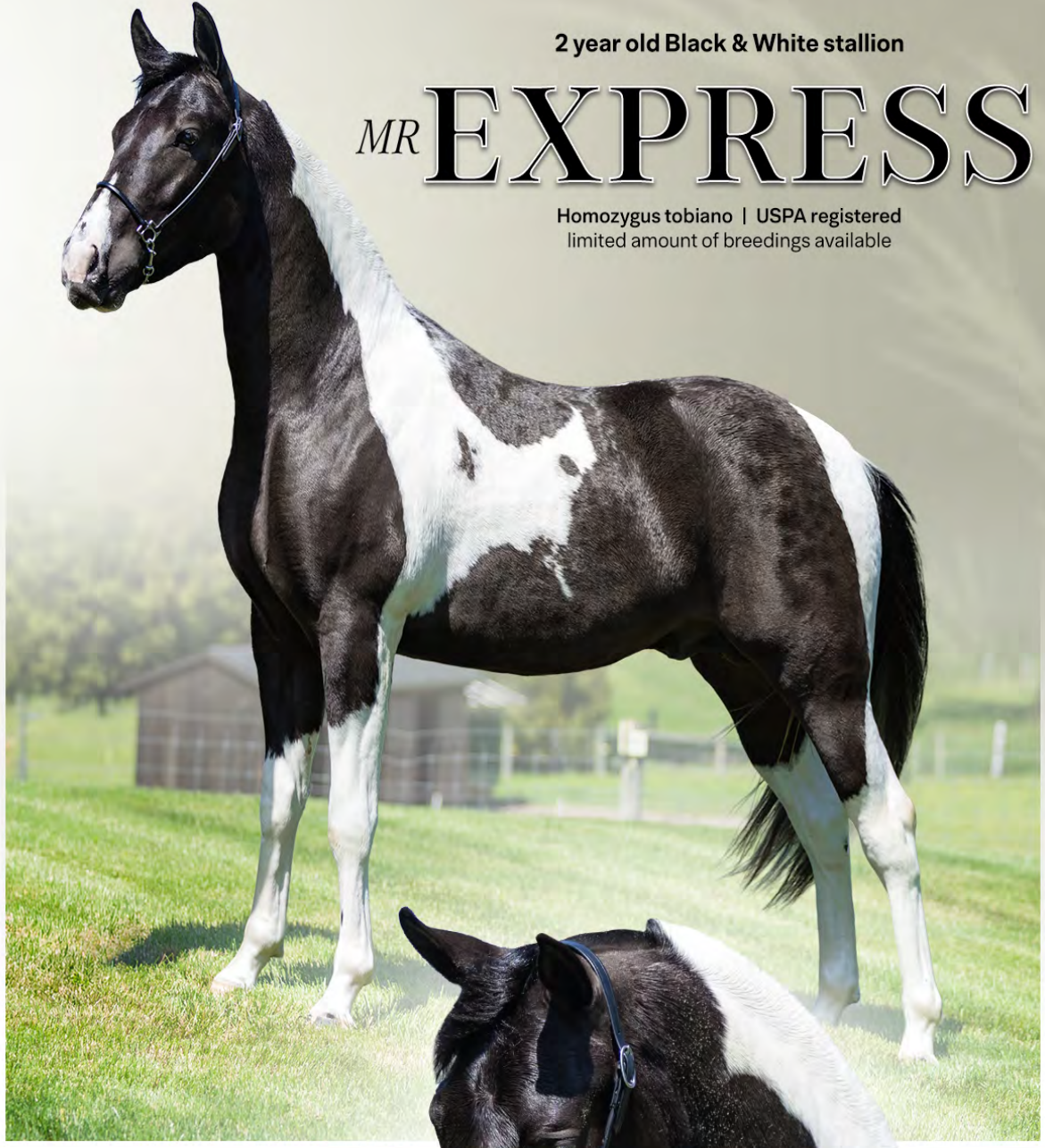

photos & design by JHunt Media

standing at  
**HEARTLAND STABLES**  
**(717) 475-9466**  
located in Gordonville PA



OFFERED FOR PRIVATE SALE

# HLS WHISPERING BEAUTY

52 inch black & white mare



HORSE/TACK/CARRIAGES

- In foal to TME Northern Lights
- USPA registered

**\$17,500.00**

all inquiries direct to  
**HEARTLAND STABLES**  
**(717) 475-9466**

*photos & design by JHunt Media*

# JACK

Proven Mammoth Jack, \$700.00 Service Fee  
Known to produce blonde mules with a lot of sense.  
*Formally from the Issac Zook family in KY.  
Shipped semen Available*

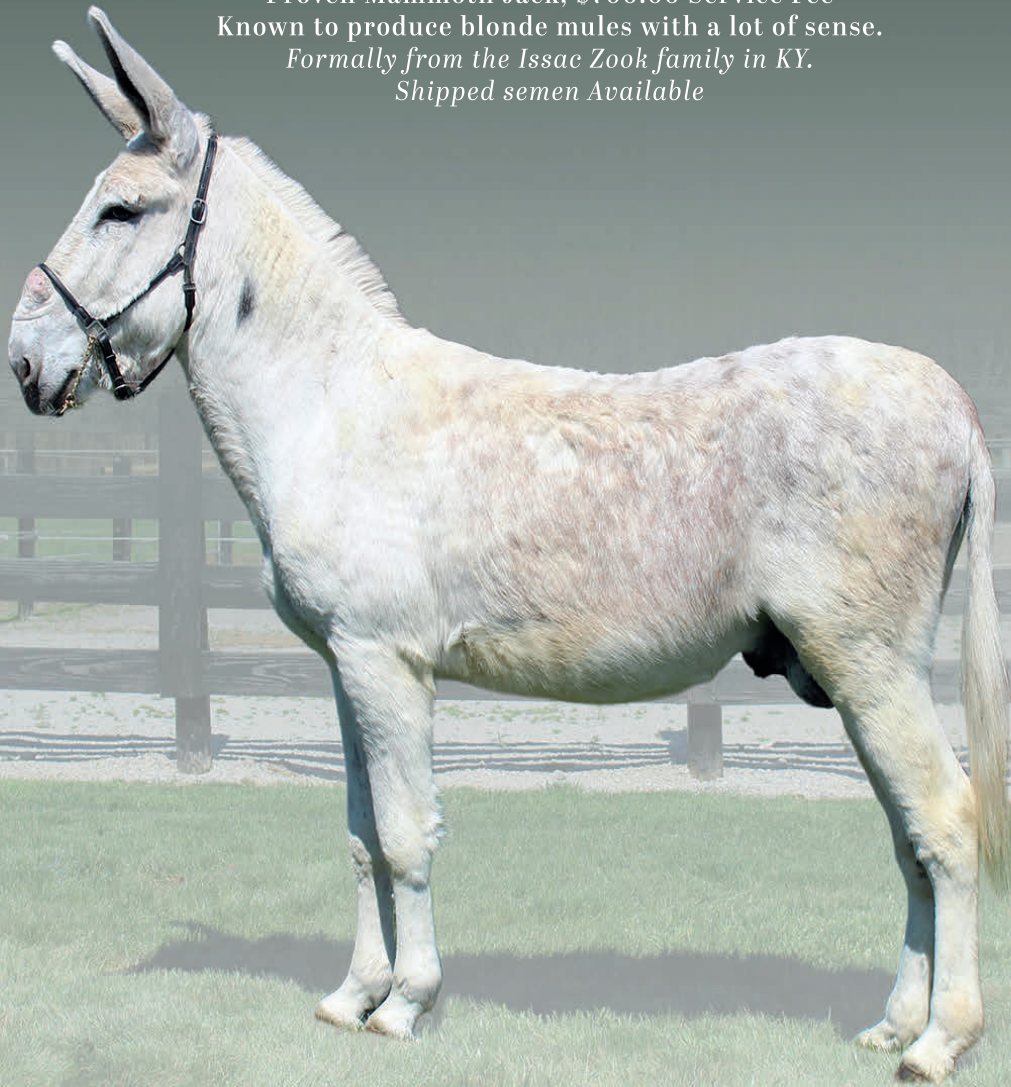

 **InkScape**  
MEMBER OF

 **FountainNook**  
Stables

Harry Yoder | 330-231-4548

# LOOKING TO SELL YOUR HORSES?



Check Out New Name & New Ownership!

**Sale Date: August 21-22, 2026**

Consignment deadline: July 1, 2026 (or until Full)

**SALE WILL BE INDOORS!**

LOCATION: Keystone Horse Center LLC  
Bloomsburg, PA 17815

## AUCTION CONSIGNMENT AND SALES AGREEMENT

HORSE/TACK/CARRIAGES

Consignor/Owner	Agent (leave blank if same as consignor)
Address	Address
City/State/Zip	City/State/Zip
Phone	Phone

Name of Horse	Sire
Year Foaled      Mare      Gelding      Stallion (circle one)	Dam
Reg. No. if applicable	Color
If mare is in foal, name of sire	Last breeding date(s)
Description	

**PLEASE FILL OUT ALL INFO AND INCLUDE COPY OF REGISTRATION**

Photos of consignments can be e-mailed as a color JPG file at 300 dpi to [tripleddruss1991@gmail.com](mailto:tripleddruss1991@gmail.com)

**ORIGINAL REGISTRATION CERTIFICATE, CURRENT COGGINS, RHINO FLU SHOT AND HEALTH CERTIFICATE MUST BE TURNED INTO SALES OFFICE AT CHECK IN.**

Consignment Fee: **\$150.00 (US Funds)** payable with return of contract (non-refundable) after July 12th.

**NO SALE IS NOT AN OPTION.** Please buy your horse back if needed. Commission: **6%** (\$250.00 minimum, \$800 maximum)

Make proceeds check payable to: \_\_\_\_\_ Agent      \_\_\_\_\_ Consignor/Owner

Consignor agrees to indemnify and hold WVMHS harmless from all costs, claims and expenses incurred because of question to title pedigree, physical condition, identity, engagements or resulting from claims against the animal proceeds from the sale. The registration certificate of each animal listed as registered must be furnished with a clear title of ownership by the consignor. The consignor authorizes WVMHS to act on his agent in the transfer of the registration certificate. I enter the animal described above for sale at the White Deer Morgan Horse Sale in Bloomsburg, PA subject to conditions hereon, and on the reverse side of consignment and sales agreement which I acknowledge to have carefully read and examined, and which I fully accept and agree to be the contract between us.

Signature of owner or authorized agent: \_\_\_\_\_ Date: \_\_\_\_\_

Mail completed consignment form, copy of registration papers (if applicable), and consignment fee (checks made payable to Mountain View Morgan Horse Sale) to: **Aaron Fisher | 167 Beiler Dr. | Rebersburg, PA 16872 | 814-404-4190 | [ecs@upwardprint.com](mailto:ecs@upwardprint.com)**  
**Daniel Fisher | 602 Mackeyville Rd. | Mill Hall, PA 17751 | 570-726-0001 | David King 717-842-0092**

# A&M's LEONARDO

Dondersteen x JD's Alivia by Plains Liberator

Leonardo's oldest 3 year old is headed to the *Spring Buckeye Sale*



### Offspring

Sired by Leonardo out of a  
Andover Hall mare



Trained & Presented by: Lamar Hochstetler 574.364.0849  
Assistant Trainers: Lyndon Glick, Orla Schlabach  
Standing at: Sterling Dreams 574.535.4887 | [sterlingdreams.com](http://sterlingdreams.com)  
Owned by: Matthew Steury





Automatic drinker ideal for all types of livestock. **\$410<sup>00</sup>**



Featuring a unique tub design with valve protection, high efficiency float valve and **extreme freeze resistance**. Extremely durable construction. Virtually maintenance free. No gas or electric wires to cause potential shock. Will not rot or rust. Can be used for all size animals.

◀ *User friendly design allows for easy cleaning and service of the drinker.*



**DURA BOWL**



**IT'S NOT YOUR AVERAGE BOWL!**

Unique features include a larger deeper bowl, stainless hardware, extremely durable construction that is designed to stay cleaner and it easily mounts in cow and horse barns.



**\$67<sup>95</sup>**

**Kit Includes:**

- Dura Bowl • Stainless hardware,
- Stainless attaching bracket
- High flow valve.



**FEED CART**

Hard rubber wheels, top dress compartments, gas cylinders for lid, aluminum frames. Standard w/cylinders 200 lbs. capacity.....**\$565.00**  
 300 lbs. capacity..... **\$598.00**  
 500 lbs. capacity..... **\$690.00**  
 Mineral Boxes.....ea. **\$19.00**



**KENNEL CARTS**

2 & 3 compartment feed bins, riser on lid for multipurpose work surface, lightweight aluminum frame, hard rubber wheels, gas cylinders for lid  
 2 - Bin Cart..... **\$516.00**  
 3 - Bin Cart..... **\$562.00**



**TACK BOX**

Pushes like a wheelbarrow, hideaway handles, halter hooks, gas cylinders for lid Standard w/cylinders grey w/white trim..... **\$575.00**  
 Large w/cylinders (6" longer) . **\$610.00**

**DELUXE TACK BOX**

Efficient storage space with convenient front drawer, sturdy rubber caster wheels, folds for ease of stow and go, gas cylinder lifts on lid  
 Deluxe Harness and Tack.....**\$839.00**

**FARRIER CART**

Heavy duty 3" casters, nailboxes w/sliding lids, pistol Grip, Standard w/Pistol Grip Handle (Best Seller).....**\$305.00**

Distributed by:



**717-715-3498**  
 332 Hollow Road  
 Quarryville, PA 17566

Dealer inquiries welcome.  
 Call for wholesale pricing.

HORSE/TACK/CARRIAGES

# ANR *Just Fishen* aka *Justin*

*Just Dewey It x  
Cherry Hill*

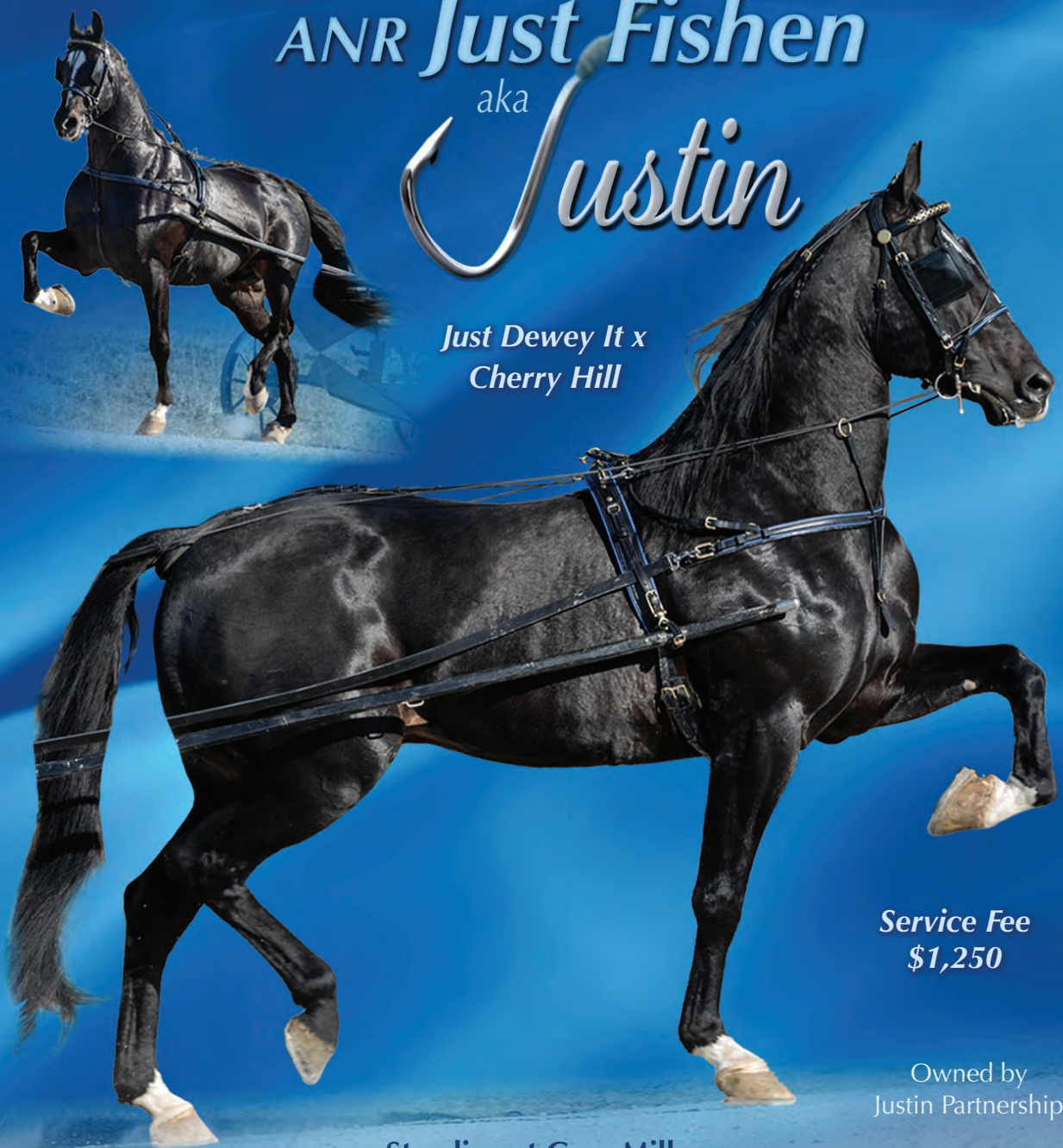

*Service Fee  
\$1,250*

Owned by  
Justin Partnership

**Standing at Gary Miller  
2539 655th Ave., Albia, IA 52531 • 641.242.2720**



**Donerail Mare  
Sold for \$12,500**



**3 yr old Keystone Nordic  
Gelding Sold for  
\$24,000**



**Yearling Penbookie Filly  
Sold for \$28,000**

*THE 6TH ANNUAL*  
  
**EASTERN**  
*Classic*  
 HACKNEY SALE

*Join us on*  
**JUNE 5TH & 6TH**  
**2026**

TO BE HELD AT:  
**THE ROMANO 4-H CENTER**  
 1841 HORSESHOE PK. - HONEY BROOK, PA 19344

**\*\*NEW FOR 2026\*\***  
**THE EASTERN CLASSIC FUTURITY**

Proceeds from our  
**Stallion Service Auction**  
 will be put into a **Jackpot**, giving the  
 future offspring from these breedings  
 the opportunity to come  
 back and compete for the  
 Futurity Purse.

**A QUICK LOOK AT A FEW OF OUR EARLY CONSIGNMENTS!**



**7 YR. OLD STUB**  
 BY TWIN WILLOW'S HANDSOME DAN  
 DAM BY DUN-HAVEN LITTLE KING



**8 YR. OLD MARE**  
 BY D-H CENTER OF ATTENTION  
 DAM BY TWIN WILLOW'S MCMILLAN



**5 YR. OLD STUB**  
 BY BRISTOLWOOD CRIMSON GLORY  
 DAM BY KNIGHT'S ELECTRIC SPARK



**21 YR. OLD MARE**  
 BY SILVER SCREEN - DAM BY PZAZZ  
 IN FOAL TO PLATINUM EDITION



**3 YR. OLD GELDING**  
 BY HEARTLAND CODEBREAKER  
 DAM BY DUN-HAVEN BANDOLIER



**7 YR. OLD MARE**  
 BY REGAL'S CENTURIAN  
 DAM BY DUN-HAVEN HIGHLY ACCLAIMED



**3 YR. OLD MARE**  
 BY HEARTLAND CODEBREAKER  
 DAM BY HEARTLAND CODE OF HONOR



**11 YR. OLD MARE - BY T/O SHAMROCK**  
 DAM BY DUN-HAVEN CENTER ATTRACTION  
 [FOAL BY MR. HIGH ROLLER]



**YEARLING STALLION**  
 BY MR. HIGH ROLLER  
 DAM BY T/O SHAMROCK



**3 YR. OLD GELDING**  
 BY HEARTLAND CODEBREAKER  
 DAM BY X-TREME



**3 YR. OLD MARE**  
 BY REGAL'S BE HIGH  
 DAM BY DUN-HAVEN REGAL ATTRACTION

Find us on 

WWW

**SALE COMMITTEE MEMBERS:** MELVIN STOLTZFUS (717) 419-6560 MELVIN STOLTZFUS JR. (610) 273-4383 SAM STOLTZFUS (717) 951-0167  
 WWW.EASTERNCLASSICHACKNEYSALE.COM - EASTERNCLASSICHACKNEYSALE@GMAIL.COM

HORSETACK/CARRIAGES

# WINNER RECEIVES 3 BOXES OF SISELYTE FREE!

Sponsored by Lena Rose Lapp

**Lapps Health & Happiness**  
5923 Wanner Rd  
Narvon PA 17555  
717-723-1665



**FIRE N ICE**  
A very refreshing natural energy summer drink!



**SISEL ESSENTIAL**  
These 2 products have ingredients that support different health challenges, allergies, leaky gut, skin rashes, and so much more.



**SISELYTES**  
Amazing kidney support! Do you have a hard time sweating? This may be your answer.



**SISELRIPT**  
Great for any kind of surgery to prevent scar tissue. Great support for headaches, tight muscles, and for your hard to handle child.

## ARE YOU NEW TO SISEL???

Do you or your family members struggle with heat strokes, fatigue, headaches, tight – sore muscles, gut issues, food intolerances or have children that are unhappy and hard to handle?

### THERE IS HOPE FOR YOU...

WHAT IF – only adding 1 or 2 support products to your daily regimen – would change your life for the better??? Sisel Will not use any harmful ingredients, their no.1 goal is to formulate safe products that change people's lives for the better!

Our goal is to learn with you and walk beside you as you begin your journey of experiencing better health and more happiness!

We strive to help you get the best pricing and answer questions to the best of our knowledge...

Give us a call today or send a letter and we would be delighted to send you FREE samples, newsletters, product info and more.

All first time orders receive FREE shipping and a free gift... call to find out what our May and June specials are!!

We look forward to connecting with you as making new friends is something our family enjoys...

### Free Giveaway:

3 boxes  
Siselytes



## CONGRATULATIONS

Winners from Sadie Zook

Henry Schwartz - Seymour, MO

Spring arrives in whispered light,  
Soft petals waking from winter's night,  
The air hums sweet with budding trees,  
And earth exhales in gentle breeze.

In garden rows, new life takes hold,  
Green tendrils push through patient soil,  
Hands in dirt, a quiet art,  
Each seed a promise from the heart.

Colors bloom in bright array,  
Bees drift slowly on their way,  
And in change of sun and rain,  
The world feels young and whole again.

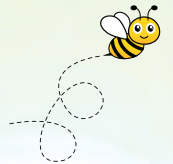

## Find little Frisky Jr. for a chance to win!

I have found Frisky Jr. on Page \_\_\_\_\_

Volume \_\_\_\_\_ No. \_\_\_\_\_

Please enter my name in the drawing to win the FREE Give-Away!

The drawing will be held approximately 4 weeks after publication date.

Name \_\_\_\_\_

Address \_\_\_\_\_

City \_\_\_\_\_ State \_\_\_\_\_ Zip \_\_\_\_\_

Phone \_\_\_\_\_

Email \_\_\_\_\_

**\*TO QUALIFY FOR DRAWING - ALL ENTRIES MUST BE MAILED TO SPONSOR ADDRESS AS FOLLOWS, ANY ENTRIES RECEIVED BY THE BUSY BEAVER WILL NOT BE ENTERED.**

- Are you new to Sisel?
- If yes, would you like Sisel info?
- Are you using products currently?
- Do you have a Sisel ID#

### CLIP AND MAIL TO:

**Lapp's Health & Happiness**  
5923 Wanner Rd  
Narvon PA 17555

Coupon Code:  
TK195

Drawing will be for:  
WINNER RECEIVES FREE 3 BOXES SISELYTES  
One winner per Busy Beaver location!!

The Busy Beaver of PA+ I  
The Busy Beaver of OH I  
The Busy Beaver of Michiana I  
The Busy Beaver of NY+ & Canada I  
The Busy Beaver of Tuckessee & Beyond I

To list your business for **FREE** in the business **Spotlight**.

**Call: 330-204-9199**

HORSE/TACK/CARRIAGES

# THE BUSY BEAVER™ *EXTREME* ECONOMY SECTION

Starting in the June 12 Edition



HORSETACK/CARRIAGES

**ECONOMY SECTION:**

*Economy section ads not eligible for discounts.*

**CALL: 800-218-3405**

Full page.....**\$847**

Half page.....**\$547**

Quarter page.....**\$395**



# RHS

## Scratches Salve & Thrush Treatment

For treatment of "scratches" on horses.

Now in a Convenient Squeeze Bottle!

VERY EFFECTIVE

EASY TO USE

### -Testimonies -

*I had a horse with scratches so bad, I couldn't drive him. We applied Scratches Salve twice a day and by the third day, he wasn't lame anymore and in a week, it was pretty much cleared up.*

- A.M. OH

*My horse had a minor case of scratches, and after using Scratches Salve a few days, it was gone.*

- D.R. OH

Manufactured by:  
Raber's Harness & Supply  
6761 Twp. Rd. 652  
Millersburg, OH 44654



For treatment of "thrush" in horses.

Works Very Well to Dry Out Thrush.

Only a Few Applications Needed if Dry Bedding is Provided.

### - Directions -

Clean out frog area very well. Apply thrush treatment liberally. Provide dry bedding.

For Wholesale Inquiries Contact:

Oregon Ag  
1150 E. Oregon Rd.  
Lititz, PA 17543  
717-656-0067  
or  
Hillside Harness  
4205 Twp. Rd. 629  
Millersburg, OH 44654

Ask for these products at your local tack store.

# “MINI RIDER”

BEE Line Enterprise | Shipshewana IN

260-768-9165 x 5

Fax 260-390-2084

Lightweight

All Aluminum

A very lightweight unit  
Specifically desinged for the  
mini ponies 34" and under.

Mini Riders In Stock.



Dealer  
Inquiries  
Welcome

### DEALER INFO.

Eastside Harness  
Topeka, IN  
260-593-2646

Woodruff Harness  
LaGrange, IN  
260-463-6762

Midstate Harness  
Michigan  
989-386-4808

Eash Harness  
Millersburg, IN  
574-642-4374

M-K Farm Harness  
231-928-6451

Clyde Leinbach  
Missouri  
660-489-2442

Marvin Yoder  
Iowa  
563-880-1986

Back Forty Home Supplies  
1431 CR 740 E  
Johnsonville IL 62850

Timber Creek Acres  
7451 TR 551  
Holmesville OH 44633  
330-600-1261

Melissa Miller  
4932 Stroups Hickox Rd  
West Farmington OH 44491  
330-974-8861

Andrew Bontrager  
26781 CR 6  
LaJara CO 81140  
719-298-6829

HORSETACK/CARRIAGES

RIDE THE

*Rails*

Break The Bank K x Donerail x Pine Chip  
PA Eligible • REG #6NG39 • DOB 04/30/2015



scan to see a video of  
Ride The Rails in action.  
YouTube: JHunt Media

FIRST COLLECTION  
& SHIPPING FREE

photos & design by JHunt Media



Shipped Semen | On Farm Breeding | 1 Yr Return Privilege  
Standing at Blue Mtn Equine - (717) 446-1309 | Owned & presented by The Smoker Brothers

# Take your growing experience to the next level!

Add **Humus Compost** into your fertility program.

**Humus Compost** is an all-natural, organic compost that will increase your plant's access to mineral in the soil. It will loosen your soil making the environment better for plant roots and soil biology. It is also both a biological stimulant and a biological inoculant.



**Humus Supreme** is an easy-to-use soil amendment and fertility product that can be layered on top of planted seed to help with germination, emergence, and moisture control. **If applied in the fall with the cover crop, it will help to increase soil pore space for a healthier growing environment.**

**Terra Preta Garden Blend** is a wide spectrum Humus Compost and minerals blend ready to add to your soil. With Humus Compost, Bio-Char, Gypsum, Rock Phosphate, Basalt, Aragonite, Potassium Sulfate, and Sea-90, it will super-charge your soil for increased capacity to grow plants. Additionally, it will expand soil biology, improve water management, and improve fertilizer availability.



**Raised-Bed Soil** is a blend of composted wood products, Humus Compost, and minerals to create a soil that is not only ready to plant into, but also has potential to produce a crop for years.

**Liquid Humus Extract** is a great addition to other fertilizer programs. By adding Liquid Humus Extract to other liquid products, a grower will increase the effectiveness of foliar and injected fertilizers. Use as a stand-alone foliar supplement also boosts photosynthesis and adds to the plants growth.

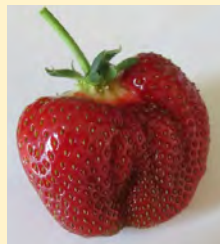

**Semo Humus 573-321-0218**

32169 Co Rd 337, Advance MO 63730

Or call your local dealer today:

Miller Farm Supply 217-543-3324

Daniel Troyer 618-713-4427

Loren Miller 502-755-4022

## Humus Supreme



- Humus Compost with minerals blended to increase the efficacy:
- ▲ Adds soil biology
  - ▲ Improves drought tolerance
  - ▲ Increases nutrient density in food
  - ▲ Improves mineral (NPK) availability
  - ▲ Adds long-term carbon to the soil
  - ▲ Improves soil structure and air exchange
  - ▲ Adds plant available calcium

Soil Health = Plant Health = Nutritious Food



Ingredients: Humus Compost, Aragonite, Basalt rock dust, Sea-90  
2,000 lb bulk bags  
1,000 lb bulk bags  
40 lb bags

**Application**  
Band in 30" row: 20 lb per 100' of row  
Broadcast per 1000sq ft: 40 to 400 lb  
Broadcast per acre: 1/2 to 7.5 tons  
Note: Can be applied annually at min rate

## Terra Preta Garden Blend



- ▲ Stimulates root growth
- ▲ Manages water—decreases drought stress and increases drainage
- ▲ Loosens the soil
- ▲ Provides the plant with a large spectrum of nutrients
- ▲ Adds carbon to soil
- ▲ Improves germination and emergence

**Application**

Band in 30" row 40 lb per 100' of row  
Broadcast per 1000sq ft 150 to 700 lb  
Broadcast per acre: 3 to 15 tons  
Note: Can be applied annually at min rate

a blend of Humus Compost, BioChar, Basalt, Soft Rock Phosphate, Gypsum, Aragonite, Potassium Sulfate, and Sea-90 mineral



2,000 lb Bulk Bag  
1,000 lb Bulk Bag  
40 lb bag

Soil Health = Plant Health = Nutritious Food

## RAISED BED SOIL



Made from: Pine Bark, Compost, Humus, Clay, Composted Chicken Litter, Aragonite, TerraPreta(Humus, BioChar, Rock Minerals)



Soil Health = Plant Health = Nutritious Food

2,000 lb bulk bag

## Liquid Humus Extract

Made with Extract-Grade Humus Compost.

Soil Health = Plant Health = Nutritious Food

Use N-Converter as an activator, immediately before use  
Add 32oz N-Converter per 10 gal Humus Extract.  
Apply to soil: 15 to 20 gal. per acre  
Foliar Application: 10 to 15 gal. per acre  
Liquid Humus Extract can be mixed with most fertilizers and chemicals for increased effectiveness.  
Store out of the sun and in a cool place.



275 gal. tote, 2-1/2 gal. jug

Two part product: Liquid Humus Extract and N-Converter

INDUSTRY

It's time to start applying OVB to your fields and gardens.



Also available in 1.2 cubic foot bag



Actual results after 2 applications of OVB Garden Blend

Prevent your fruit trees from **FREEZING** in temperatures as low as 16° Use FXI (Fire Extinguisher), Biome Food & Harmonizer



If you want better nutrition.... you need to start with better soil

Biochar blends available for various farming needs, call for more information.

**WHAT IS BIOCHAR?**

Our Biochar is steam activated carbon that is beneficial for our soils and animals

- Biochar creates a biology in your soil that saves money on fertilizer inputs.
- Biochar has the unique ability for attracting and holding moisture, nutrients, and agrochemicals, even retaining difficult to hold nutrients like nitrogen and phosphorus. Nitrogen and phosphorus tend to run off regular soils, upsetting the ecosystem balance in streams and water ways.
- Biochar creates better bedding for chicken houses, dairy cows, sheep, and horses.
- Mix it to your feed for better animal health, and a good manure.

**WHAT IS THE BENEFIT TO YOU?**

- Saves costs over high fertilizer year after year.
- Creates a healthier environment for you and your family.
- No dangerous side effects to humans, animals, or ecosystems.
- Puts more dollars in your pocket.



Distributed by:

**Keystone Sales**

717-715-3498  
332 Hollow Road  
Quarryville, PA 17566

Now carrying the full line of **Blue GOLD** PRODUCTS

Dealer inquiries welcome. Call for wholesale pricing.

INDUSTRY

STORE AT ROOM TEMPERATURE

NOT FOR HUMAN CONSUMPTION

SHAKE WELL BEFORE USE

### Active Ingredients

- ▲ 99% USP Toltrazuril 50mg/ml
- Other Ingredients:**
- ▲ Vegetable Glycerin derived from plant oils
- ▲ Preservatives
- ▲ Binding Agents with natural flavor

# Vetr

## ToltraMax®

Toltrazuril 5%

### Directions & Storage

- ▲ ToltraMax should be administered orally, and retreatment may be needed after 4 to 6 weeks.
- ▲ Keep out of the reach of children.
- ▲ Store at room temp at or below 77° Fahrenheit.

Approved for use in pregnant or lactating female animals. Safe for use in puppies/kittens over four weeks of age.

### High-Potency Antiprotozoal Agent

### Dosage

**1mL per 5 pounds for 3-5 days**

For treatment and prevention of coccidiosis (protozoal infection) in puppies and adult dogs.

No more Toltrazuril prescriptions needed! This is an over-the-counter option that is 100% legalized and FDA approved.

2.5% and 10% strengths also available



Kennel Suppliers, Check in!! This item is a HUGE SELLER in Ohio. We have several size and flavor options available. Wholesale inquiries welcome. We offer a complete line of dewormers at very affordable price. For wholesale opportunity call **Cactus Critter Care LLC (812) 787-2813**



**Farm Stores and Tack Shops, check in!** We offer the below as an affordable version of the name brand dewormers. We have a complete line of dewormers for all farm species, including cattle and sheep drenches. Wholesale inquiries welcome. Call for product list.

# PraziMectin®

Compare to Equimax® Paste

**(812) 787-2813**

Anthelmintic and Boticide **Apple Flavor**

Formulated to remove worms and bots with a single dose

**Oral Paste for Horses**

1 Syringe ■ 0.22 oz

**Active Ingredients**  
Praziquantel 14.03%  
Ivermectin 1.87%

NDC: 86213-773-01  
MANUFACTURED BY VETR



# Primacur®

Equine Dewormer | 10% Fenbendazole

**1 Dose • 1 Syringe • 6.5mg**

Designed for an average size horse up to 1250 lbs

MANUFACTURED BY VETR

**Active Ingredients**  
Fenbendazole

Treatment and control of internal parasites in horses



Compare to **Safeguard Equine® Paste**

We also offer Ivermectin paste at a great price!



INDUSTRY



Our top-selling fly spray for a reason! **Elimafly Natural Fly Spray** keeps flies at bay the natural way. Crafted with a powerful blend of herbs, essential oils, and Basic H, it delivers effective protection without harsh chemicals. Gentle on your horse and safe for use in barns, pastures, and around the home, it's a trusted, family-friendly solution you can rely on every day.

We make products you can trust!

**MADE IN USA**



INDUSTRY

The most effective natural cleaner for farm, barn, & home on the market!



**NEW PRODUCT**

2026 WHOLESALE CATALOG AVAILABLE NOW!



*Wholesalers: Request yours today.*

**Retail customers: Shop small!**  
Request Hillside Harness products at your local shop.

**Wholesaler Specializing in Horse Tack, Hardware & Supplies**

call: (330) 893-1510 | fax: (855) 279-4023

# What will you discover in your cup?



It's good!

## Rosie's Roost Premium Organic Coffee



patience



HUMOR



COURAGE



Roasted to order for optimum flavor and freshness!

Coffee worth crowing about!

Name \_\_\_\_\_

Address \_\_\_\_\_

Phone# \_\_\_\_\_

\$18.00 per 12 oz. bag    Ground \_\_\_\_\_    Whole Bean \_\_\_\_\_

1-5 12 oz. bags    \$6.00 shipping

6 or more bags    FREE shipping

Quantity \_\_\_\_\_

Amount \$ \_\_\_\_\_

Shipping \$ \_\_\_\_\_

Total \$ \_\_\_\_\_

Please Make payment to: Rosie's Roost

Mail coffee orders to: P.O. Box 86, Argyle, WI 53504

Shipping only to the continental US.



**COLOMBIAN**  
Medium Roast

INDUSTRY

# Beuta<sup>®</sup>

Effortlessly Elevated Landscape Edging



**PURCHASE AT A DEALER NEAR YOU**

Riverside Woodcraft, Salvisa, KY

859-865-4997



Create a custom backyard space

**ASK ABOUT BEUTA AT YOUR LOCAL LAWN AND GARDEN CENTER OR FARM STORE!**  
If they aren't carrying it, tell them to reach out to us!



# Sea-90<sup>®</sup>

## OCEAN MINERALS

QUESTIONS  
FOR SEA-90?:  
**(770) 361-6092**

### Sea-90 Lightning Rescue

Organic-certified fungal rescue treatment. Apply at the first sign of mold, fungus, or disease.

**Summer Disease Support**



Lab tested to kill > 99.9%:

- Alfatoxin
- White Mold
- Greening Disease
- Yellow Leaf / Blight

Plus effective on dozens of others!



### GARLIC SEASON HAS ARRIVED!

New from Sea-90:

**NEW!**

Sea-90 Bio-Wave Max. OMRI-Listed, Spore-based biostimulant to rejuvenate and jumpstart your soil microbiome for more productive and fertile soil.



Improve fertilizer productivity (do more with less!) and overall soil health and fertility

### SALES AND DISTRIBUTION INFORMATION:

#### Illinois / Iowa:

Kenneth Yoder  
(217) 322 - 8953  
Sheldon Heading  
(815) 499 - 1332

#### Iowa:

Neal Lambright  
(641) 658 - 2879  
Green View Ag.  
(319) 656 - 1106

#### Kentucky:

Levi Stoltzfus  
(606) 267 - 4359  
Esh Farm Store  
(270) 886 - 9352

#### Wisconsin / MN:

Natural Ag Sol.  
• In Platteville  
• Contact David Stoltzfus for dealers

#### Virginia

Gold Hill Farm Sup.  
(434) 414 - 6369  
**OK, TX, & KS:**  
Lynn Hoover  
(717) 580 - 1458

INDUSTRY



UNLEASH THE BULLS



Count on it.

# SMOKE vs GRILL

No matter what you prefer, we got you covered.

Gas grills, pellet grills, smokers, and lots of accessories!

Maximize your efficiency with easy-to-learn controls, top-line reliability, and professional cutting.



Toro's walk-behind mowers are easier than ever to drive, work even better in pastures, and host many attachments, such as snow plows, dump beds, light kits, spreaders, and sprayers.

Available in 36", 48", 54", and 60" decks.



7700 State Route 241,  
Millersburg, OH 44654  
**330-674-4329**  
Mon-Fri : 6-5 · Sat : 7-11





# BRADLEY HYDROSTAT STAND ON MOWER

**FEATURES:**

- Easy to drive
- 25 hp electric start engine
- 48", 52" or 60" widths
- 3 blades
- Up to 8 mph mowing speed
- Max 4.2 acres per hour
- Hour meter
- 3 yr warranty
- 1½" to 4" adjustable mowing height

48" \$4,799.00  
 52" \$4,999.00  
 60" \$5,700.00

STAND ON:  
 52" \$6,199.00  
 60" \$6,999.00

- Fast – 10 mph
- 3 yr warranty
- Heavy 7 gauge welded deck



## Falcon Engine LLC

66780 CR 33, GOSHEN, IN 46528  
 574-642-4353

INDUSTRY

# ONE TRACTOR DOES IT ALL.



TWO-WHEEL TRACTORS

HANDLES ROTATE 180°

Flail Mower  
24", 30" & 35"



Hay Rake



30" HD  
Combo Mower



Log Splitter

Plastic Mulch  
Layer



Power Harrow  
21", 30" & 32"

Snow Thrower  
24" & 28"



Power Sweeper  
20", 40" & 48"



Chipper/Shredder



Sickle Bar Mower  
30", 40", 45" & 53"



Water Pump



Pressure Washer



Buddy Cart



Brush Mower  
21", 26" & 32"



RearTine Tiller  
18", 20", 26", 30" & 33"



Rotary Plow

**Additional Attachments Available**

- 40" Snow Blade
- Lawn Mower W/ Catcher 22" & 38"
- Utility Trailer 1,100lbs
- Spreader
- Dethatcher
- Drag Implements
- 36" Dozer Blade
- Power Potato Digger
- Two Stage Snow Thrower 28" & 33"
- Power Ridger
- Dual-Action Sickle Bar Mower 47", 51", 59", 67", 71" & 82"

**BCS TWO-WHEEL TRACTORS  
 POWER ALL THESE ATTACHMENTS AND MORE!**



## Falcon Engine LLC

66780 CR 33, GOSHEN, IN 46528 — 574-642-4353

# 401 Freezeless Hydrants

DESIGNED TO LAST A LIFETIME  
- ALL STAINLESS MODEL



## Trail Plumbing LTD

COMPLETE PLUMBING SALES AND SERVICE

4278 County Road 168 | Millersburg, OH 44654

330.893.3423

330.893.3437

trailplumbing.com

LOCALLY MADE IN HOLMES COUNTY, OHIO

▪ DEALER INQUIRES WELCOME ▪

We ship **FedEx**

# GO PLACES WHERE NO-ONE ELSE GOES.

0% FINANCING AVAILABLE!  
\*see store for details



WORKS GREAT IN PASTURES



WE DELIVER TO YOU

## FERRIS FW 45

- FX Kawasaki Engine
  - 48", 52" and 61" Cutting Width
  - 7 MPH Ground Speed
  - EZ Deck Height Adjustment
  - Powerful ZT 3400 Transaxles with Remote Oil Cooler
  - Cast Iron Greasable Blade Spindles
- Call to find out why this is the best built Walk Behind on the market!!

COMPATIBLE WITH

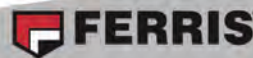

CALL 330-893-3033  
4741 STATE ROUTE 557  
MILLERSBURG, OH 44654



CALL 330-359-0330  
2310 US ROUTE 62  
DUNDEE, OH 44624



KJM Soul Commander  
Prepped by Sangre Farms

## Boost your horse's performance.



### Step it up with Horse Glo.

Horse Glo produces more energy through increased blood flow. It also provides additional joint support and promotes muscle growth. Feed as a top dress in combination with Hy-Brix Equine Daily.



Virtually all sickness and disease can be traced back to mineral deficiencies or imbalances.

Contact us to find a dealer near you.

**888.803.8811**

sales@naturalwayminerals.com

INDUSTRY



Call for information  
**859-209-1643**  
Crab Orchard, KY

## Built Big for Big Jobs

**MODEL 2540**  
**4 Ton Capacity**  
**Standard Features**

- Roll Tarp
- 12,000 lb. Rubber Torsion Suspension Axle



Put **VARICAST** Spreading Solutions to work on your Farm!  
Ask for Your Local Dealer

Fertilizer | Lime | Compost | Poultry Litter  
**VARICAST Spreaders Handle It All!**

**Kirkwood**  
EQUIPMENT AND MANUFACTURING LLC

834 Pumping Station Rd.  
Kirkwood, PA 17536

**717-529-3299**

## SAFETY SPIKE

### Equip. in Stock

- Fore Carts
- Bale Movers
- Seat Brackets
- Multiflora Dentist
- Carriage Tongues
- Line-of-Draft
- Corrector



- General Repairs
- Custom Designing
- Custom Painting

### Spike Mounts on Pioneer PTO Carts.

#### Safety features:

Put spike in ground when dismounting cart, to secure your horses.

## FFI FAMILY FARM INNOVATIONS

EQUIPMENT MANUFACTURING

4549 TR 156  
Millersburg, OH 44654

**330-893-0591 / 330-390-4159**

INDUSTRY

## Buying Quality



Sheep & Goats



Direct off your farm

**Daniel Riehl**

**484-796-3952**

Call for info on  
**Breeding, feeding and Ethnic Holidays**

## Flooring Sale

¾" Thick Solid Hardwood - End Matched - T&G:	Per Sq/Ft
2-1/4" Prefinished Hickory - First Quality	\$2.50
2-1/4" Unfinished Red Oak #2 Common (Very Nice!)	\$1.60
2-1/4" Unfinished Red Oak #2 Common (shorts)	\$1.08
Happy Feet Vinyl <b>Loose Lay 22mil</b> wear layer	\$3.35



Easy to install with **no adhesive** or locking system, 100% waterproof, and very durable. Great for basements, concrete, or subfloors. Buy 1,440 sq. ft. or more and save 14¢ per sq. ft. on your entire order. We have all these options and many more in stock!

Post Frame Buildings 12149 Gower Rd \* Glenford OH 43739 Phone: (740) 659-1480



## Dedicated Flatbed & Horse Hauling

Weekly Routes: Lancaster, PA to Hopkinsville, KY

- F550 & F350 Available
- 30' & 40' Flatbed Gooseneck Trailers
- 30' 4-Horse Draft Horse Trailer
- Enclosed Gooseneck Trailers
- Tarp Loads • Specialty Dedicated Loads
- Pallet Quantities • Equipment • Agriculture
- Safe, Comfortable Horse Transportation

Fully Licensed & Insured  
in the Lower 48 States and Canada

87 Mill St, Fawn Grove, PA 17321



Call Dispatch:  
**(717) 798-9300 EXT 5**  
Call or Text:  
**(717) 335-1785**



## A-M GUTTER GUARD™

The Difference is in the DESIGN



### EASY TO INSTALL IN NEW OR EXISTING GUTTERS

- Compatible to Spike-n-ferrule and hidden hanger (1 size fits all!)
- Heavy gauge .018 - 100% aluminum - will never rust
- Invisible from the ground
- Handles downpours
- Top rated ★★★★★
- Pest & weather (snow/ice) resistant
- Does not make contact with shingles (will not void shingle warranty)
- Wholesale pricing for installers & distributors
- Eliminates gutter clogging & promotes air flow
- Design reduces pressure points

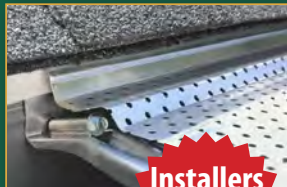
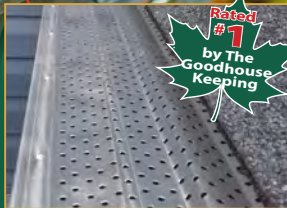

Installers  
get .40 off  
on skids

## Trucking

**40' Livestock Trailer  
w/removable Double Deck**

**13 Horse Slant Load Trailer**  
(Horse Trailer also Available to Rent)

**Daniel Riehl**  
**484-796-3952**

**Located In Central MO**

## Levi's Custom Benchwagons



FIBERGLASS BOX & ROOF  
POPLAR BENCHES  
CUSTOM INTERIOR  
COMPLETELY FURNISHED  
OR PARTIALLY FURNISHED

LEVI & ELSIE MILLER  
51500 CR 29  
BRISTOL, IN 46507  
(574) 825-3083



**RAYDEN ENTERPRISES LLC**  
Home of A-M Gutter Guard | Where Quality Comes First

**440-321-5336**

**amgutterguards.com**

# CALL TO ORDER YOUR POLE BARN PACKAGE

40 YEAR WARRANTY | 30+ COLORS IN STOCK

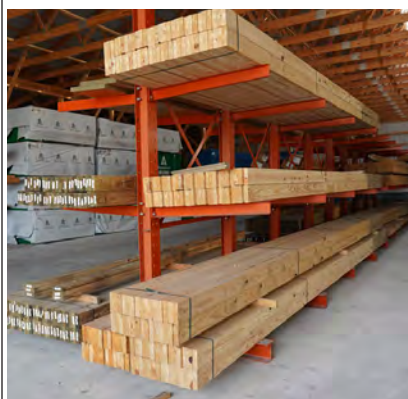

## DELIVERY AVAILABLE

- Lumber • Insulation
- Designer Metals
- Pole Barn Packages
- Doors • Windows
- Accessories • Hardware
- Standing Seam + Board & Batten
- Job Site Roll Off



7877 S US Hwy. 27 Berne, IN 46711  
260.251.4366

INDUSTRY

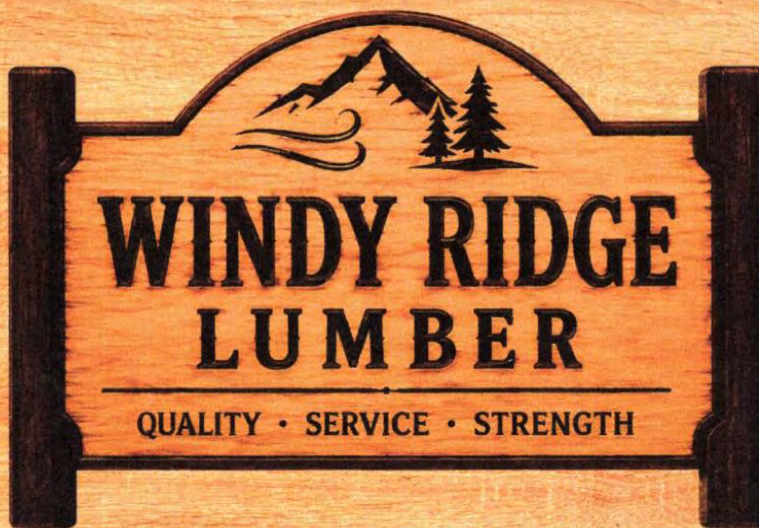

- BANDSAW PINE LUMBER
- POLE BARN PACKAGES
- BOARD & BATTEN
- TIMBER IN ALL SIZES - LENGTH
- FULL 2" CUT FOR TRAILER BEDS
- TOUNGE & GROOVE

**ALSO AVAILABLE IN POPLAR!**

MUNFORDVILLE, KY | 270-473-1384 | PINELUMBER@IBYFAX.COM

# MAXIMIZE YOUR SPACE



From retail spaces to warehousing and beyond, we have the racking solutions to fit your needs. Call today for a free quote.

**Call Or Stop By Today For A Complete List Of Products**



2017 Toyota 8FDU25 Diesel, 5,000 lb cap, 3 stage, sideshift, fork positioning, 2,460 hrs  
**\$21,000**



2018 Doosan D255-7 Diesel, 5,000 lb cap, 3 stage, sideshift, 1,857 hrs  
**\$11,100**



2020 Linde H40D Diesel, 8,000 lb cap, 2 stage, single double forks, 15,312 hrs  
**\$16,100**



2021 Hyster H50FT LP, 5,000 lb cap, 3 stage, sideshift, 7,056 hrs  
**\$14,100**



2018 Yale GLP070 LP, 7,000 lb cap, 2 stage, sideshift, 3,306 hrs  
**\$10,100**



2021 Toyota 8FGCU25 LP, 5,000 lb cap, 3 stage, sideshift, fork positioning, 12,720 hrs  
**\$9,900**



2015 Komatsu FG25ST-16 LP, 5,000 lb cap, 3 stage, sideshift, 3,235 hrs  
**\$8,700**



2022 Toyota 8HBW23 EL, 4,500 lb cap, With built-in 120v charger  
**\$2,900**

**Financing • Rentals • Delivery • 30 Day Warranty**  
**Call Today For More Info**

Industrial Systems Group is a division of Yoder Produce inc.  
9599 S. Apple Creek Road Fredericksburg, OH 44627  
Phone: 330.695.5900 Email: [sales@yodersproduce.com](mailto:sales@yodersproduce.com)



# Superior Products For Food Storage & More

Find a full lineup of QP products available at your local store

# QP

QUALITY PLASTICS, LLC

Plastic Injection Molding



## Helping You Develop An Alternate Solution

From practical features to advanced material options, let us help guide you from design to finished product on the market. Call or stop by our location to discuss your ideas.

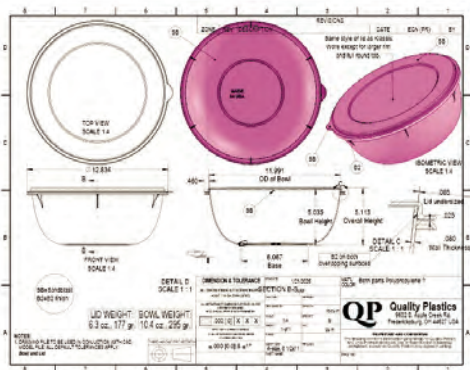

Find QP Products at your local store  
Or online at: [store.qualityplasticsllc.com](http://store.qualityplasticsllc.com)

## 330.695.5920

9602 S. Apple Creek Road Fredericksburg, OH 44627

[www.qualityplasticsllc.com](http://www.qualityplasticsllc.com)

INDUSTRY

# GENSET PARTS, DELIVERED!

## Kubota

Authorized Dealer and Service Provider

## LOOKING FOR GENSET PARTS & SERVICE?

### • 1000+ Parts In-Stock

With a wide selection of parts in-stock, we have what you need for emergencies or simple maintenance. We also ship daily for added convenience.

### • Kubota Certified Team

Our team of technicians has 60+ collective years of genset experience along with our Kubota Tier 4 Certifications. We also offer phone support, allowing us to diagnose your situation and get you back up and running as quickly as possible.

### • Fully Stocked Lineup

We have a wide variety of New and Used Gensets, from 8 KW to 50 KW. Each used unit is remanufactured to keep it running strong for years to come.

## CALL TODAY! (260) 768-4216



700 N Morton St  
Shipshewana, IN 46565  
(260) 768-4216

## Mid Ohio Sliding Door Components

### Delrin Wheels with Ball Bearings

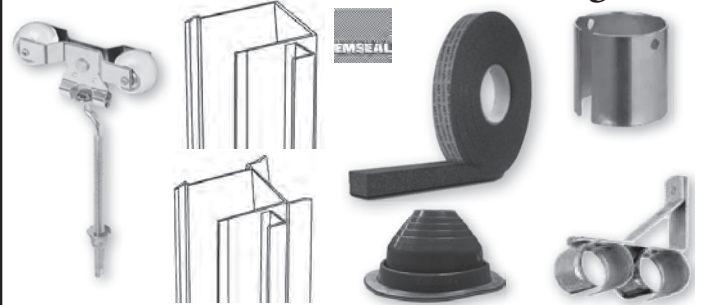

### Manufacturing Round Keyhole Track

Palram Duraclad PVC Interlocking Liner Panel



Plyco Insulated Door



Sunsky 9" Clear

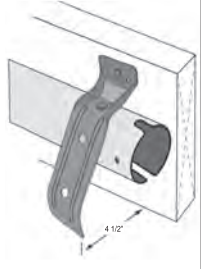
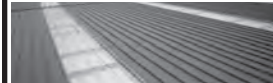

— WHOLESALE ONLY —

FOR PRICING, WRITE TO: 7055 Twp. Rd. 82, Bellville, Ohio 44813

## BELTS! BELTS! BELTS!

- Bale Thrower Belts
- Round Baler Belts
- H&S Hay Merger Belts
- Oxbo Merger Belts
- NH Inverter Belts
- Pre-Punched Pick Up Head Belts
- Grain Elevator Belts
- Grape Harvester Cleated Belts
- Sawmill Related Belts
- Sanding & Moulder Belts
- Endless Transmission Belts
- Sand & Gravel Belts

*We build custom conveyor rollers.*



Check with us before buying factory direct.  
Excellent after market pricing on Merger & Baler belting.

Most belts in stock and ship UPS daily.

Flexco Alligator & Clipper Lacing Distributors

**Need a custom belt made? Give us a call.**



7724 Banks Road • Gainesville, NY 14066 • 585.567.2358  
Hours are 7:00 to 3:30 pm Monday through Friday.

# The Most Energy Efficient Dehumidifier

Efficiently draws only **COP 2.27 L/kWh**

**115 V / 60 HZ**

Powers from your inverter/battery pack

If you want a better dehumidifier for less money, choose the **HD55(Blue)** for its great value. This Commerical Dehumidifier can remove **113 Pints** at saturation, up to **1,200 Sq. Ft.**, lowering the humidity to a comfortable level in a short period.



**5 YEARS WARRANTY**



**\$695**  
Plus shipping  
**\$30 shipping.**

**Order Early!**  
While Supplies Last!

“ We have been installing AlorAir Sentinel HD55 units for over two years. The HD55 is our go to unit. This unit has a small footprint but is a work horse. — Paula

**93%** of customers recommend this item.

Call **330-600-1359**

**Millstone Place**  
P.O. Box 289, Berlin OH 44610

INDUSTRY

## WHITETAIL LIFE



**Unmatched lineup of proven authors,**

- Bobby Worthington
- Alan Foster
- Joe Miles
- Wes Delks

- Dr. Bronson Strickland
- Jake Ehlinger
- Sam Collora
- Derek Borkholder
- Don Higgins and more...

**Bi-Monthly Magazine**  
Don Higgins, Editor

Writers guidelines:  
**Don Higgins**  
don@whitetaillife.com

Article submissions:  
**Derek Borkholder**  
derek@whitetaillife.com  
800-414-0686

Advertising:  
**Joas Yoder**  
joas@whitetaillife.com  
574-399-0424

### Whitetail Life Subscription Form

Name: \_\_\_\_\_  
Address: \_\_\_\_\_  
Phone: \_\_\_\_\_ Fax: \_\_\_\_\_  
Email: \_\_\_\_\_ Signature: \_\_\_\_\_

**Subscription:**  
**USA:**  
**\$19.99** 1 year  
**\$37.99** 2 years  
**Canadian:**  
**\$49.99** 1 year  
**\$97.00** 2 years

Bi-Monthly Magazine:  
6 Issues Per Year  
Your subscription will automatically renew with the payment method provided unless you cancel it.  
 Check box to cancel auto renew

**PAYMENT INFO:** INV # (office use only): \_\_\_\_\_  
Check# \_\_\_\_\_ AMT: \_\_\_\_\_  
Type of card:  American Express  Visa  MasterCard  Discover  
Credit Card#: \_\_\_\_\_  
Name (as it appears on the card): \_\_\_\_\_  
EXP: \_\_\_\_\_ CVC CODE (on back): \_\_\_\_\_  
Phone #: \_\_\_\_\_ (required for credit card use)

Mail this form and payment to:

**Whitetail Life**  
**PO Box 3**  
**Charm, OH 44617**

Call **330-204-9199**  
with credit card information

email this form to:  
**sales@whitetaillife.com**



# WESTWIND WILDLIFE

Tagout Technique has grown because of great customers and our ability to support your adventures. This growth has inspired us to start a local store with hand-selected products that you can personally experience at our new location or view in our future catalogs.

**This new retail store will be called WestWind.**

**WESTWIND IS MORE THAN JUST A STORE—IT'S YOUR NEW BASECAMP FOR DISCOVERY IN AND AROUND THE MIDWEST.**

**We are passionate about connecting our community with the beautiful outdoors.**

Whether you're planning a quick hike, a family excursion, a serious hunting trip, or a complete property makeover, we will be ready to serve you. We're curating a selection of high-quality products to fuel all your future hunting and exploration needs.





Tagout Technique will continue to serve with Property Consulting and Habitat Management.



WestWind will be your store for all the supplies and needs to explore your property and the great outdoors.

## JOIN US FOR THE GRAND OPENING OF WESTWIND WILDLIFE

 19<sup>th</sup> and 20<sup>th</sup> of June

 2525 Birch Road, Bremen, IN 46506

**574-248-9667**

**The *ONLY MINERAL* that has over 90 sea minerals resulting in more robust bucks, does & fawns!!**  
**Expect increased antler growth through nutritional genetic expression!**



**Feed Minerals, Not Just Salt, Now For The Future...  
 Feed OVER-160... More Robust Does & Fawns  
 Which Will Be Your Future Target Buck!!**

**ANOTHER BRUISER FOR THE WALL!!**  
**Congratulations to another happy customer on landing this nice 11 point 142" Buck after feeding OVER-160!!**

Never seen anything attract deer like Over-160. This buck was first seen while in the velvet stage and he never left the farm until he was shot on the first day of archery. We always struggled to hold deer on our farm, so obviously we are pretty impressed. Another happy Over-160 customer....



**Over 160**  
**ORIGINAL**

**Deer Mineral**



**7 Reasons To Consider Feeding Over 160 Minerals**

- ☞ Powerful Toxin Binder That Works Immediately to Flush Out Toxins & Parasites.
- ☞ Sea-90 Trace Mineral Salt Containing Over 90 Sea Minerals for Maximum Health.
  - ☞ Humic Acids, Check Out The Research On How It Effects CWD.  
 Bio Available Humic Acid Ingredient affects CWD. National library of medicine <https://www.ncbi.nlm.nih.gov/>
- ☞ Not Just Salt, Highest Concentration of Vitamins & Minerals on the Market.
- ☞ Expect Increased Antler Growth Through Nutritional Genetic Expression.  
<https://extension.msstate.edu/publications/the-role-genetics-and-nutrition-deer-management>
- ☞ Over 160 Daylight Contains a Proprietary Deer Activating Blend of Ingredients Formulated to Keep Bucks More Active During Daylight Hours.
- ☞ Bottom Line is.... Stronger, Healthier, and More Robust Bucks, Does, and Fawns!!

*Disclaimer: Always check federal, state, and local hunting regulations before using this product. Laws and regulations vary by state regarding feeding or baiting of deer.*

Dealer  
 Inquires  
 Welcome.

**Oregon Ag LLC, 1150 E Oregon Rd., Lititz, Pa, 17543**  
**717-656-0067 info@oregonagllc.com**

Available at  
 Agri-Tonic  
 Dealers

# Spray Your Plants With....



## BIO-ENHANCED MICRONUTRIENTS

### FOR A FULL GENETIC EXPRESSION

BIGGER LEAVES - STRONGER STEMS - BIGGER FLOWERS!

- Easy Application & Fast Results
- Perfect Nutrition for Mighty Plants



**SUPER CONCENTRATED**



Gallon      Gallon



8 oz      8 oz      8 oz

#### Order Form

Name \_\_\_\_\_

Address \_\_\_\_\_

City, ST, Zip \_\_\_\_\_

Size	Qty	Price	Subtotal
8 oz	_____	\$25 each	_____
32 oz	_____	\$55 each	_____
1 Gallon	_____	\$150 each	_____
2.5 Gallon	_____	\$320 each	_____

OH residents add 7.75% sales tax \$ \_\_\_\_\_  
 Shipping for orders under \$100 \$17  
 Shipping for orders \$101-\$300 \$25  
 Shipping for orders \$301-\$500 \$35  
 Shipping for orders over \$501 Call for price.

Bio Char Pricing includes shipping \$ 0.00  
 20 lb Bio Char \$45 each X \_\_\_\_\_ = \_\_\_\_\_  
 Total \$ \_\_\_\_\_

#### 5 REASONS TO USE MIKES MIGHTY MICROS.

- IT IS 100% ALL NATURAL AND CHEMICAL FREE.
- IT CAN BE USED ON ANY PLANT, TREE, OR SHRUB.
- START SEEING RESULTS IN ONLY A FEW WEEKS TIME.
- WILL DEVELOP WHAT IT NEEDS TO BE DISEASE RESISTANT, AND INSECT RESISTANT NATURALLY THROUGH NUTRITION.
- THERE ARE NO OTHER PRODUCTS LIKE THIS THAT CAN DELIVER THESE KIND OF RESULTS NATURALLY

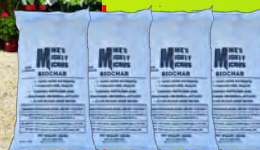
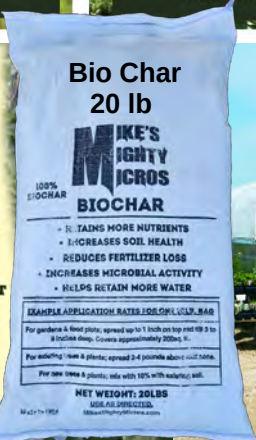

**Mound Archery**

30250 TR 212, Fresno, OH 43824  
 Or call 330-234-9449

HUNTING/SPORTING/GRILLS

*Frisky Jr. is trying to help his little chick friend find his way home.*

*Follow the tracks with your pencil.*

*If you take the wrong path,*

*the little chick will end up at Mr Fox's house.*

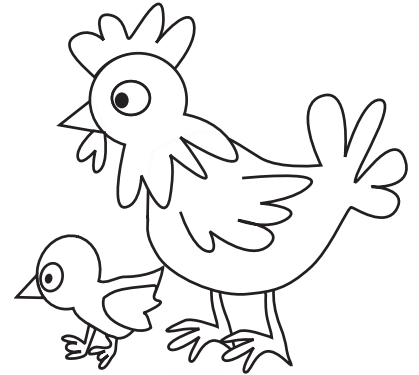

**HOME!**

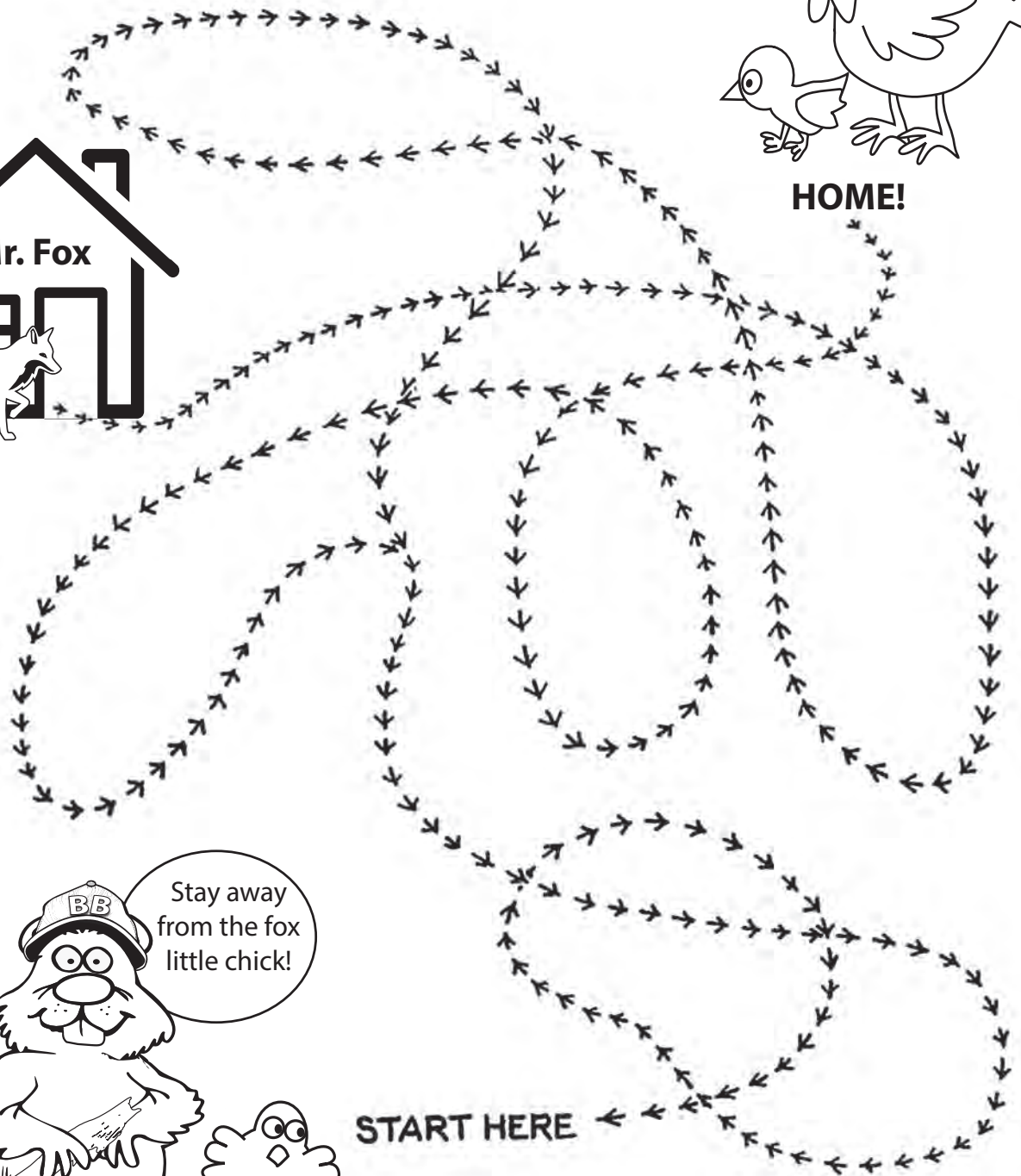

**START HERE**

*The Busy Beaver **EXTREME**™*  
*Have your ad seen in over 90,000 Plain Homes!*

**EXTREMELY** effective

**EXTREMELY** efficient

**EXTREMELY** economical

**4X**  
**EXTREME**  
**COVERAGE**

**NOW**  
**EVERY**  
**14 DAYS!**

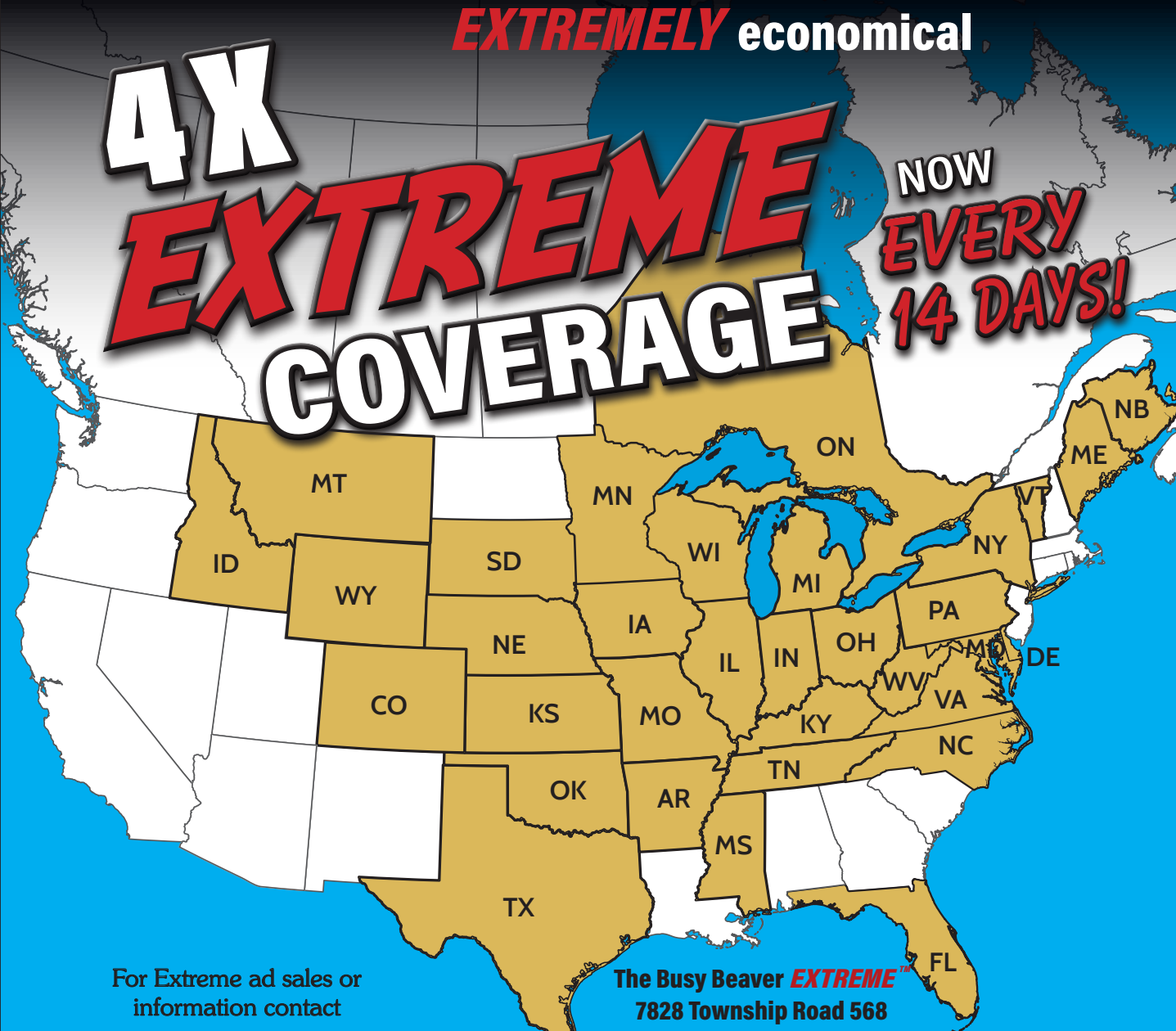

HUNTING/SPORTING/GRILLS

For Extreme ad sales or information contact

**John Zook**

**717-847-6254**

[jzook@busybeaverextreme.com](mailto:jzook@busybeaverextreme.com)

The Busy Beaver **EXTREME**™

7828 Township Road 568

Fredericksburg, Ohio 44627

Phone: 800-218-3405

Fax: 330-470-2240

[ads@busybeaverextreme.com](mailto:ads@busybeaverextreme.com)

*Take your business to the **EXTREME** level!*

**2026 DEADLINES:**

June 9 - June 23 - July 7 - July 21

# THE BUSY BEAVER EXTREME™ 2026

The Busy Beaver **EXTREME** is mailed **EVERY 14 DAYS!**  
 4 X more options to grow your business with covers, display ads, classified ads and inserts.

**ADVERTISE MORE, SAVE MORE WITH OUR MULTI-RUN DISCOUNTS!**

**RUN 2 TIMES: 10% DISCOUNT - RUN 3-4 TIMES: 15% DISCOUNT - RUN 5 OR MORE TIMES: 20% DISCOUNT**

AD SIZE	REG PRICE	10% OFF (2 TIMES)*	15% OFF (3-4 TIMES)*	20% OFF (5+ TIMES)*	*TO RECEIVE THE 10%, 15% OR 20% DISCOUNTS, ALL ADS MUST BE PAID IN FULL AT TIME OF ORDER. NO OTHER DISCOUNTS CAN BE APPLIED. CALL FOR MORE INFO.
Extreme Classified	\$75 <small>For first 12 words</small>	Refer to the Extreme Classified Ad Form for pricing			
1/4 PAGE (3.5" w x 4.75" h)	\$655	\$589.50	\$556.75 PER TIME	\$524 PER TIME	
1/2 PAGE HORIZONTAL (7.25" w x 4.75" h)	\$895	\$805.50	\$760.75 PER TIME	\$716 PER TIME	
1/2 PAGE VERTICAL (3.5" w x 9.75" h)	\$895	\$805.50	\$760.75 PER TIME	\$716 PER TIME	
FULL PAGE (7.25" w x 9.75" h)	\$1485	\$1336.50	\$1262.25 PER TIME	\$1188 PER TIME	
FRONT COVER (8.125" w x 10.75" h) <small>+ .125 bleed &amp; .25 safety</small>	Call for availability and pricing			Need catalogs and flyers sent as onserts with the Extreme? Call for pricing.	
BACK COVER, INSIDE FRONT COVER (7.25" w x 9.75" h)	Call for availability and pricing				

**Starting in the June 12 Edition**

**ECONOMY SECTION:** Non-gloss pages, more value, same great coverage.  
 Full page...\$847 Half page...\$547 Quarter page...\$395 Economy section ads not eligible for discounts.

Busy Beaver Extreme™ - 7828 Township Road 568 - Fredericksburg, Ohio 44627  
 email: ads@busybeaverextreme.com - Phone: 800-218-3405 - FAX: 330-470-2240

## BUSY BEAVER EXTREME AD ORDER FORM | 2026

Horse name or item you're advertising: \_\_\_\_\_ Designer: \_\_\_\_\_

Business Name: \_\_\_\_\_ Contact: \_\_\_\_\_

Address: \_\_\_\_\_ City: \_\_\_\_\_ St: \_\_\_\_\_ Zip: \_\_\_\_\_

Phone: \_\_\_\_\_ Fax: \_\_\_\_\_

Email: \_\_\_\_\_

**- AD SIZE:**  1/4  1/2 Horizontal  1/2 Vertical  Full **Times to run:** \_\_\_\_\_

**- SECTION:**  Economy  Horses  Dog related  Health/Naturals  Farm/Garden  Household  Shop/Tools  Hunting/Sport/Travel

**- DO WE HAVE YOUR AD ON FILE?**  No  Yes: Date last ran: \_\_\_\_\_

**- IF NOT, HOW WILL YOUR AD BE SENT TO US?**  Mail  Email

**PAYMENT INFO:** INVOICE# (office use only): \_\_\_\_\_

Discount (if applicable) \_\_\_\_\_%

**Payment:**  Please invoice address above  
 Check # \_\_\_\_\_

**To pay with credit card:** talk to a representative, by phone or in person.

*Do NOT send credit card information via email*

**ALL ADS MUST BE PRINT-READY WHEN SUBMITTED.**

This special publication will be printed every 14 days in full color and delivered to over **85,000 homes\*!**

(\*NY, ME, MD, DE, VT, VA, NC, WV, PA, OH, MI, IN, KY, TN, IL, WI, MO, IA, MN, AR, TX, OK, KS, CO, MT, ID, NE, WY & Canada)

WE RESERVE THE RIGHT TO REFUSE ANY ADS WE DEEM INAPPROPRIATE. Busy Beaver EXTREME is not responsible for the claims and outcome of products advertised within.



HUNTING/SPORTING/GRILLS

## Aloe Vera Gel

To be used topically on your entire body. Designed using only high quality, non-toxic ingredients beginning with the purest Aloe Vera. Now available in a convenient squeeze bottle.

**Excellent for:** Burns, cuts, poison ivy, refreshing after shave and even as a non-toxic shaving cream.

*I use this gel every night on my face after my shower. When I apply it to new acne pop ups it goes away within a day! Just started using it in my scalp to hopefully help the itchiness and dryness. Love this stuff!*

– Ashley

## Shampoo and Conditioner

Shampoo made with 50% Aloe Vera Juice, Conditioner made with 60% Aloe Vera Juice. Designed using only high quality, non-toxic ingredients beginning with the purest Aloe Vera. Available in 12 oz. size.



To place an order contact your Tuckesse Distributor

Countryside Groceries

**641-722-3046**

# CALL 1-800-222-3610 TO GET A COPY OF DR. MARTINS **BRAND NEW** (DCCN, DACBN) **LIMITED RELEASE BOOK**

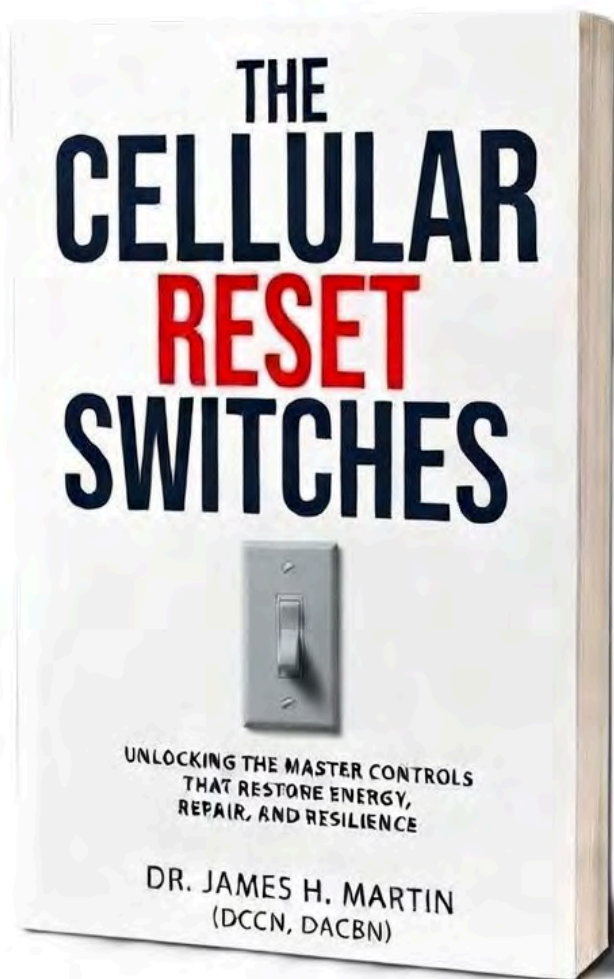

**OUR MISSION IS  
TO EDUCATE AND  
HELP AS MANY  
PEOPLE AS  
POSSIBLE,  
NATURALLY.**

**THERE IS  
ABSOLUTELY NO  
CHARGE TO THE  
FIRST 149 CALLERS.**

**DO NOT WAIT TO TAKE THE MOST IMPORTANT  
STEP IN YOUR CELLULAR HEALTH.**

Disclaimer: For educational purposes only. We do not claim to treat, cure, diagnose, or prevent disease. These statements have not been evaluated by the Food and Drug Administration.

# Pressure Point Mat Set

Lay back, breathe deep, and let the tension melt away.

*Great Gift!*  
for **Father's Day**

**\$138** for the mat.  
Add **\$12** for shipping.



Studies have shown up to 40% improvement for, stress, muscle soreness, and sleep quality after regular use of the mat for 20–30 minutes before bed. *Journal of Sleep Therapy 2015*



Unroll your pressure point mat and pillow on a flat surface and ease onto it slowly, allowing your body to adjust. The gentle pressure of over 4,000 pressure points works to stimulate circulation, release muscle tension, and support relaxation. Start with 10–15 minutes a day and gradually increase to 20–40 minutes as your body gets used to the sensation. Use daily or as needed to support deep rest, stress relief, and full-body rejuvenation.

I absolutely love this pressure point mat! It's become a part of my daily routine and helps me relax and unwind like nothing else. I've even gifted it to friends, and they're obsessed with it too. Highly recommend for anyone looking to relieve tension and feel amazing! – *WTHN Client*

**What's Included:**

- High-quality coconut fiber and linen WTHN Pressure Point Mat
- Luxe memory foam and linen WTHN Pressure Point Pillow for ultimate comfort
- On-the-go linen carrying case for WTHN Pressure Point Pillow and Mat
- Detailed how-to guide with step-by-step instructions and Pressure Points for healing at home and on to go.



Name \_\_\_\_\_

Address \_\_\_\_\_

City \_\_\_\_\_ State \_\_\_\_\_ Zip \_\_\_\_\_

Phone \_\_\_\_\_

Qty \_\_\_\_\_ Price EA \_\_\_\_\_ Sub Total \_\_\_\_\_ Shipping \_\_\_\_\_ Total \_\_\_\_\_

*OH residents add 7% sales tax*

\*These statements have not been evaluated by the Food and Drug Administration. This product is not intended to diagnose, treat, cure, or prevent any disease. The information provided on this site is not intended to replace or serve as an alternative to advice from healthcare professionals. Results may vary.

The Blooming Thistle, 216 West Stewart Ave, West Lafayette OH 43845 • Call 740-291-9848

HEALTH/HOME/CLOTHING

Therapy in the Palm of Your Hands!

# Rapid Release THERAPY

POWERFUL, SAFE, EFFECTIVE!

Rapid Release™ is helping our equestrians, trainers and Veterinarians care for their horses and themselves with our patented high-speed vibration. FDA Class 1 Medical Devices approved for human and animal use with amazing results!

### TRY BEFORE YOU BUY!

Rental units available for \$100 a week.

Purchase a unit within the first 30 days of signing rental agreement and we'll use your rental money towards the purchase price.

Retail Price

**\$1199**

includes 2 rechargeable batteries and charger



## Cordless PRO3

- 5 built-in treatment surfaces each creating a different effect
- Uniquely suited for extremities
- Meticulously engineered and balanced mechanism for smooth operation
- No attachments to change or lose
- The Pro3 is ideally suited for horse and human care. What is it worth to you?
- Treatments typically last just 2-5 minutes
- For pain, muscle tension and movement
- Designed and built to withstand professional use

## 90-Day Money Back GUARANTEE!



Helps eliminate sore muscle pain!



## PRO-AM Massager

- 1. Treatment Disk:** Head-to-toe, whole body therapy
- 2. Large Tip:** Go-to for most applications.
- 3. Soft Tip:** Use on sensitive or tender areas
- 4. Power Band:** Offers most intense vibration
- 5. Acupoint:** Penetrates deep into smaller, troubled spots.

- High speed vibration
- 4 speeds
- 5 built in treatment heads
- Self contained rechargeable battery
- Full body therapy
- Economical



**5 IN 1 TREATMENT**

**\$799**



### Canada Dealer:

West Paw Kennel Supplies • 4340 Lichty Rd RR1 Wallenstein, ON N0B250 **519-698-0707**

Distributed by:



717-715-3498

332 Hollow Road Quarryville, PA 17566

Dealer inquiries welcome. Call for wholesale pricing.

HEALTH/HOME/CLOTHING

# My Best Mornings Start With .....

## Moringa Hot Chocolate – An Easy Way to Get A Lot Of Nutrition!



- Helps in maintaining healthy circulatory system
- Aids in improving elasticity of blood vessels
- Helps reduce high-fat diet-induced obesity
- Gives relief from bronchial asthma
- Beneficial for maintaining healthy brain
- Helps to lower LDL cholesterol and glucose levels
- Improves insulin resistance and glucose metabolism



Start your family off right with a cup of the **MOST NUTRIENT** filled hot chocolate on the market, **CocoRinga**. Children adore it. Adults crave it, and Science approves it! This incredibly tasty and delicious Super Food Hot Cocoa is packed with immune boosting, anti-inflammatory and antioxidant ingredients. A unique blend of Miracle Food Moringa, high fiber plant creamer, and rich dark cocoa. **CocoRinga** helps with regularity, digestion, memory, mood, cravings and a host of other health issues. Drink at least 1 cup a day for 14 days in a row and see the difference **CocoRinga** makes for you.

HEALTH/HOME/CLOTHING

**TAKE THE 12 DAY CHALLENGE**

No GMO's **BioCoffee** Gluten Free

BioCoffee is 100% organic. A specially formulated blend of Colombian coffee and Wheatgrass. BioCoffee is the only alkaline coffee on the market. An instant drink, just add water. Mixes instantly and tastes great!

Wheatgrass is one of nature's super foods. It's equivalent to having 3-5 servings of green vegetables in one cup. BioCoffee is an excellent source of fiber, a great prebiotic and probiotic, provides chlorophyll, amino acids, vitamins, minerals and enzymes. Helps blood flow, digestion and general detoxification of the body. Wheatgrass is hailed the "King of Alkaline Foods" which helps the body from becoming acidic. An



P.O. Box 289  
4860 E Main St,  
Berlin, OH 44610

**Place Your Order Today!**  
330-403-3277



Drink Alkalizing Bio-Coffee!

# RED LIGHT THERAPY

A Non-Invasive, Drug-Free Approach to Healing



## LUMAFLEX®

A Brighter *You* Inside

### Lumaflex Red Light therapy offers a versatile, easy-to-use solution

- ▶ Clearer Brain Function
- ▶ Joint discomfort & stiffness
- ▶ Muscle soreness & recovery
- ▶ Chronic inflammatory conditions
- ▶ Post-exercise inflammation & fatigue
- ▶ Skin health & cellular repair
- ▶ Rechargeable battery included
- ▶ Abdominal pain, cramping



**\$399**  
PLUS \$12 SHIPPING.

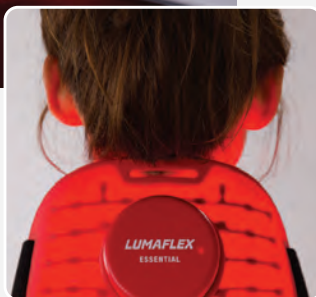

PHYSICAL PERFORMANCE & RECOVERY FINALIST



The Blooming Thistle

7296 Ridge Road SW, Fresno OH 43824

**330-997-3492**



## Bi-Monthly Magazine

### Featured Content:

- Community to community, what works best
- Health coach views
- Fellow people sharing to others.
- Specific health topics from home to home.
- Garden to table ideas
- Soil to harvest

For articles and advertising contact:

Phone: 330-204-9199

Fax: 877-822-8390

Email: [sales@anabaptisthealth.com](mailto:sales@anabaptisthealth.com)

## The Anabaptist Health Journal 2025 Subscription Form

Name: \_\_\_\_\_

Address: \_\_\_\_\_

Phone: \_\_\_\_\_ Fax: \_\_\_\_\_

Email: \_\_\_\_\_ Signature: \_\_\_\_\_

### Subscription:

USA:  
\$39.99 1 year  
\$78.00 2 years

Canadian:  
\$69.99 1 year  
\$138.00 2 years

Bi-Monthly Magazine:  
6 Issues Per Year

Your subscription will automatically renew with the payment method provided unless you cancel it.

**PAYMENT INFO:** INV # (office use only): \_\_\_\_\_

Check# \_\_\_\_\_ AMT: \_\_\_\_\_

Type of card:  American Express  Visa  MasterCard  Discover

Credit Card#: \_\_\_\_\_

Name (as it appears on the card): \_\_\_\_\_

EXP: \_\_\_\_\_ CVC CODE (on back): \_\_\_\_\_

Phone #: \_\_\_\_\_ (required for credit card use)

Mail this form and payment to:

The Anabaptist Health Journal  
PO Box 3  
Charm, OH 44617

Call 330-204-9199 with credit card information

email this form to:  
[sales@anabaptisthealth.com](mailto:sales@anabaptisthealth.com)

# No More Body Odor! Deodorant Supplement, that just works.



Call Lydia  
330-403-3277  
P.O. Box 289,  
Berlin OH 44610

**You Can Now  
Smell like mint  
instead of .....**



As of June 1st, 2026, All Millers Quality Herbs Products will have a **10% Price Increase**, Except the Millers Herbal Calciums (which will only increase 5% on 32oz, 8oz, 4 oz, 190caps).

**We also have some Half Price Items from K.R.S.:**

Vit C-500, Geri-Formula, Stress with Iron, Vit D3-1000, while supplies last. K.R.S. has a New Product: Omega 3-6-9, 1,200mg, 90 SoftGels @ \$17.95.

### New Products from Sprigs:

Cycle Wave Phase 1 Cap. Kit-\$31.00

New Wave Phase 3 Cap. Kit-\$31.00

Mama Bear Prenatal Gold, New & Improved-\$32.00

We carry all Chupps Brand Products.

OH YES! Don't forget Chupps New

Mighty Mushroom Coffees!

K-Cups, 24ct-\$28.95,

Pouch, 12oz-\$28.95,

Sticks, 24ct-\$28.95



974 Cox Road  
Wellston, OH 45692

HEALTH/ HOME/CLOTHING

**GREAT  
Spring  
Savings!**

**PLUS  
FREE shipping  
& tax!**

**Bundle 1  
NingXia Red  
4 pk**

Our price  
(34% OFF)  
**\$134.10**



**Bundle 2  
NingXia Red  
LR Kit**

Our price  
(34% OFF)  
**\$193.50**



Get up to \$100  
in FREE products  
with this bundle

4 pk (750 ml)  
NingXia Red  
30 NingXia  
Red Singles

**Bundle 3  
NingXia  
Red 8 pk**

Our price  
(34% OFF)  
**\$268.20**

8 (750ml bottles Ningxia  
Red & 2 FREE oils



**COUPON**

**FREE  
SHIPPING + TAX**

ON YOUR FIRST ORDER  
Send Coupon with Your Order.  
When ordering by phone, mention Coupon Refund!

**Your order includes:**

- Your Own FREE Wholesale Account
- FREE Information Packet
- Monthly Newsletter
- No obligation to purchase again
- Buy as many bundles as you wish

**FREE Product  
Guide  
with  
Every  
Order!**



**Place Your Order Today!**

**call: 330.521.0453**

Joseph & Kathryn Yoder  
2068 CR 61 | Millersburg, OH 44654

**Premium Quality.  
Better Results.**

Made with high-quality, carefully sourced ingredients.

**ProK Vitality**  
Renal Support

- NOT YOUR AVERAGE KIDNEY FORMULA
- FORMULATED BY A NATUROPATHIC DOCTOR
- MANUFACTURED IN THE USA
- USED BY HEALTH PRACTITIONERS IN CLINICAL SETTINGS



**AVAILABLE NOW!**

AVAILABLE FOR RETAIL AT  
**Kauffman's Treasures**  
1-877-740-0053

**Charm Wellness Center**  
330-893-1212

**Northern Nutrition**  
260-768-4868

FOR WHOLESALE INQUIRIES  
call 440-437-3600 ext. 1



**TRUE  
PLATINUM**

2394 Hague Rd  
Orwell, OH 44076

**My Hair Grew Back!**

**Place Your Order Today!**  
330-403-3277

**It Works!**



P.O. Box 289  
4860 E Main St, Berlin, OH 44610



HEALTH/HOME/CLOTHING

# COUNTRYSIDE

## Health Products

717-786-6065

Samuel & Linda Glick

4208 Red Well Dr., Gordonville, PA 17529

Call for Testimonials



Protection of dangerous EMF radiation and 5G

### Boost Products



Formulated and science proven by the worlds top professor in vitamins and cancer.

Micro daily is indeed the worlds most scientifically validated supplement



Ask about our new products

## Health & Goodness - Micro Nutrients

Dr. Prasad's Core4 Bundle offers a comprehensive approach to wellness, targeting brain, cellular, gut, skin and heart health. The combination of Micro Daily EMF, Probiotic Daily, Collagen Daily and Omega3 Daily ensures that your health is taken care of from all angles. From boosting immunity and improving brain function to promoting gut health, revitalizing skin and supporting a healthy heart, this bundle has it all.

**Holistic Health Solution:** targets key areas of health.

**Superior Value:** enjoy significant savings when you purchase the bundle.

**Effortless Wellness Routine:** Four products designed to work together for maximum benefit.

**Looking to increase your health and well being? Great results for conditions and chronic illnesses.**

- Diabetes, sugar related
- Hormonal health and obesity
- Heart and blood pressure
- Emotional and anxiety
- Parkinson's & Alzheimer's
- Thyroid gut and brain issues
- Food allergies
- Inflammation

### Basic Hydro Bundle



### Core 4 Bundle



**Also for children Micro daily gummies**

Organ and bone health • Autism • Hearing issues • Focus issues

These statements have not been evaluated by the FDA. This product is not intended to diagnose, treat, cure or prevent any disease

# Now That Is What I Want For

## HAPPY Father's DAY



- Relax Far Infrared Sauna
- In Home Unit That Works Well
- Uses minimal power, 120 Watts – 60Hz, 1400 Watts max



7296 Ridge Road, Fresno OH 43824 • Call 330-997-3492

HEALTH/HOME/CLOTHING



## ATTENTION NEIGHBORS LIVING WITH SEVERE BACK PAIN — DON'T WAIT UNTIL IT GETS WORSE

EDDIE Y. COULD BARELY CRAWL... NOW HE'S WALKING AGAIN WITHOUT SURGERY

### FREE REPORT:

HOW MANY SEVERE BACK PAIN PATIENTS AVOID SURGERY

**Eddie had been suffering with severe back pain for months.**

*"I had 5 bulged discs, 4 herniated discs, and 3 tears in my back."*

It got so bad he **couldn't walk**.

*"I had to crawl most of the time... I was off work for 3 months."*

But when Eddie came to Midwest Disc Clinic, they put him on a natural care plan — no surgery, no drugs. Things started to change within weeks.

**After completing his care plan, here's how Eddie feels now:**

***"I can walk again. The pain is finally manageable."***

*For Eddie, that means back to work. Back to his family. Back to life.*

Eddie is now one of our patients who once felt unsure — and now wants to help others decide.

 **260-261-1133**

**CALL TODAY TO RECEIVE  
YOUR FREE COPY**



#### Midwest Disc Clinic

2180N 700W Shipshewana, IN 46565   
260-261-1133 

#### Not ready to call the clinic yet?

Talk to Eddie first — neighbor to neighbor. **Call Eddie at 620-459-3338.** He'll be glad to share his story.

**Note:** If Eddie doesn't pick up, just leave a message—he'll be glad to call you back when he's free.



## A Powerful, All Natural, Toxin, Heavy Metal

# ELIMINATOR

- Promotes Detoxification
- Supports Digestive Health
- Boosts Immune System
- May Help Reduce Radiation

30 Day Supply **\$19.50**



Zeolite is a volcanic ash that forms over time when ash and lava react with alkalinized water in a non-contaminated environment. Resulting in a compound with a very strong, cage-like structure that pulls toxins out of your body instead of pushes.



## For Cuts, Scrapes and Minor Burns

- Aloe Vera, Colloidal Silver, Comfrey and Burdock leaf are used as an antibacterial and healing agent.
- Honeycomb and beeswax help with the regrowth of flesh and skin.
- Hemp oil keeps the pain level in check.

**\$14.95**



Epic Zeo Heal is a product that is formulated with the fastest and best healing protocols in mind. Zeolite has been used for years in the military to help stop bleeding.



## Moving CBD out of the past . . . Into the future.

### CBD Roll On Muscle Gel

For soreness, stiffness, or swelling.  
1800 mg ..... **\$55.00**

### CBD Gummies

Simplify your daily CBD routine.  
900 mg ..... **\$40.00**

### CBD Hand & Body Cream

Creamy, rich and soothing.  
300 mg ..... **\$30.00**

### CBD Gel Caps

Designed for optimal absorption.  
300 mg ..... **\$20.00**  
900 mg ..... **\$35.00**

### CBD Tincture

Bring balance and harmony to your day!  
300 mg ..... **\$20.00**  
900 mg ..... **\$35.00**  
1800 mg ..... **\$65.00**



Ask for Key Organics at your local health and bulk food stores



HEALTH/HOMECLOTHING

Distributed by:

**717-715-3498**  
332 Hollow Road  
Quarryville, PA 17566

Dealer inquiries welcome.  
Call for wholesale pricing.



# EXTREME Classifieds



Place a classified ad in **Busy Beaver Extreme** to **Float** to **85,000** homes  
**\$75** for the first 12 words, **\$3** per word

Call in your classified.....**800-355-2192**  
 (Mon - Fri 8-5 EST)

You may also fax **1-800-574-4204** or email **classifieds@busybeaverpublicationsllc.com**

*Ads must be paid with credit/debit card (call us w/ info). A \$3.00 convenience fee will be applied. All ads must be pre-paid to run.*

**SUBMIT A CLASSIFIED AD** Place one word only in each box below.

\$75.00 for first 12 words			
78.00	81.00	84.00	87.00
90.00	93.00	96.00	99.00
102.00	105.00	108.00	111.00
114.00	117.00	120.00	123.00
126.00	129.00	132.00	135.00
138.00	141.00	144.00	147.00
150.00	153.00	156.00	159.00

SECTION:  Horses  Dog related  Health/Naturals  Farm/Garden  
 Household  Shop/Tools  Hunting/Sport/Travel

**\$75.00** first 12 words  
**\$3** each additional word  
**per each Ad Category**  
 Cost for ONE TIME

**1**

TOTAL Number of issues

**2**

**TOTAL COST**  
 (Multiply box 1 x box 2)

**3**

**EXTREME CLASSIFIED MAIL ORDER FORM**

MAIL TO: Extreme Classifieds

7828 Township Rd. 568 | Fredericksburg, OH 44627

Mail-in classified questions....**800-218-3405**

**NO DISCOUNTS ON CLASSIFIEDS**

**Choosing more than 1 category?**  
 Remember, you must pay the full ad price for EACH category you check.

**Example:** \$75.00 ad x 2 categories x 2 times = \$300.00

Name: \_\_\_\_\_

Address: \_\_\_\_\_

City: \_\_\_\_\_ State: \_\_\_\_\_ Zip: \_\_\_\_\_

Phone: \_\_\_\_\_

For FREE, include my:  name  address  phone #

must choose at least one

**NEW!**  
**4X EXTREME**

Place your ad today to reach **85,000** homes **EVERY 14 DAYS!**

**UPCOMING DEADLINES:**  
 June 9, June 23  
 July 7, July 21

HEALTH/HOME/CLOTHING

## NEW & USED SHIPPING CONTAINERS FOR SALE

DELIVERED ANYWHERE • FAST & RELIABLE SERVICE

### Looking for a secure and affordable storage solution?

We offer a variety of new and used shipping containers ready for delivery wherever you need them. Whether it's for a job site, farm, business, or backyard—we have you covered.

- ✓ Multiple sizes available
- ✓ Wind & water tight options
- ✓ Budget-friendly pricing
- ✓ Quick turnaround

**Call or Text:  
629-258-9500**

## WE ALSO OFFER HAULING SERVICES

### Need it hauled? We can handle it.

Our trucks and trallers are ready to haul anything you need, anywhere it needs to go. From flatbed to livestock loads, we make it easy and efficient

- ✓ Flexible delivery – multiple truck
- ✓ Partial, LTL, FTL – no load too small
- ✓ Dependable and insured service

**Call or Text: 629-258-9500**

## P.O.T.S. Gathering

What: POTS Gathering

Who: All POTS patients and their care givers

When: Sept. 4-5, 2026

Where: Vernon & Laura Hochstetler  
56314 Cr 33 Middlebury, IN

**RSVP by: July 15th 2026 @ Homer Kuhns - 574.546.2506 Voicemail 1or 5**  
**Please give - name - address - phone number - amount of people attending**  
**For any questions call - Laura - 574.825.0182 or 574.849.1753**

FRIDAY AGENDA - 9am to 3pm

SATURDAY ACENDA - 9am to ?

- How being positive can make an impact on your health.
- Ehlers Danlos info:
- Vascular Compression info:
- P.O.T.S. info:
- Importance of supplements:
- Tips on caring for POTS patients:
- -Mexico clinic here to share-

- Laura's personal story
- Share your personal stories
- Share your tips
- Info on different treatment plans clinics, etc.

*Come prepared to share your stories, successes, and mingle with people who can relate to what you're going through!*

-MEALS-

Friday lunch & dinner provided  
Saturday lunch & dinner provided (by donation)

-LODGING-

Essenhaus Inn - (5 mins) - 574.207.0544  
Hampton Inn - 574.822.0288  
Elkhart & Goshen - 15-20 mins  
Airbnbs nearby  
Rvs and tents welcome on our property!

There will be booklets of info to take home!

Make copies of this invite and send to anyone you know with POTS or that has POTS symptoms but doesn't know where to start! Help spread the word to all states!

## Tools to equip you for those conversations.

**FREE!**

- Packets are available free of charge (\$60.00 value), made possible by generous donors.
- Order by phone, fax, email, or mail-in! Please allow 3-4 weeks for shipping.

### Free "Purity In the Home Packet" includes:

- Purity in the Christian Home* - Rod and Staff Publishers
- God's Will for My Body* - John Coblentz
- Living a Pure Life* - John Coblentz
- Protecting Their Purity* - Keepers Books
- When to say "NO"* - Weaverland Mennonite Publishing
- Protecting your Child's Purity* - Marvin Wengerd
- God, Our Children and the Facts of Life* - Steve & Sandra Ebersole
- Sacred Subjects, set of 7 booklets* - Pathway Bookstore

### Listen to Recorded Topics:

Dial 712-432-8774

Enter conference ID: 787343278#

Enter sharing ID followed by #

*Love & Respect* - Marvin Wengerd..... 111

*Purity in the Home* - Delbert Shetler .....116

*Protecting their Purity* - Brian Weaver .....117

List of additional recorded topics..... 100



*Blessed are the pure in heart: for they shall see God.*  
Matthew 5:8

Sister Organization  
to Free Indeed



**OUR MISSION:** "To provide Biblical-based resources to help educate and equip the Conservative Anabaptist Communities to live in Purity."

717-419-6684 • Fax: 717-256-7209 • info@pureheartresources.com • 48 Hatville Rd, Gordonville, PA 17529



## “Lions Mane Talk”

At Mushroom Maiden Farm, we believe in the same enduring principles that guide our communities: faith, family, stewardship of the land, and honest work done well. In a world that often rushes toward shortcuts, we choose a simpler, more transparent path, growing and crafting our products with care, patience, and integrity.

Our mushrooms are cultivated high in the Appalachian Mountains, where clean air, pure water, and rich forest traditions shape their strength. Every batch is tested by an independent lab to ensure purity and quality. We use 100% fruiting bodies, the part of the mushroom where the most valuable nutrients are found, so you receive only the best of what nature provides.

Our Lion’s Mane mushroom capsules are carefully prepared to support clarity and well-being, made without fillers or unnecessary additives. Alongside them, we offer two wholesome varieties of coffee, a smooth and robust dark Arabica bean, roasted for rich flavor and steady comfort and a dark Arabica bean Cinnamon Breakfast Roll coffee. To season your table, choose from four distinct mushroom enhanced salts. We offer a Wild Hickory Cold-Smoked Salt, Himalayan Pink, Sriracha, and Thai Ginger, each crafted to complement honest, home-cooked meals.

As a 100% woman-owned farm, we value humility, hard work, and transparency in every step, from growing to packaging. We are committed to straightforward practices and products you can trust for your home and family.

Simple ingredients. Careful hands. Honest quality. That is the Mushroom Maiden promise.

*The Mushroom Maiden*  
Daria Novak

**Pure Path Distribution LLC**  
P.O. Box 151 Emmitsburg, MD 21727  
1- 888-401-7747

# NEW! Teleseminar

**FORGETFUL?  
FEELING SLOW?  
MEMORY ISSUES?  
CONFUSED? TIRED?**

Everyone who calls and listens can receive a copy of Dr. Martins NEW BOOK release (DCCN, DACBN) “Cellular Reset Switches” at absolutely **NO CHARGE!**



**CALL NOW!**

**1-844-588-1195**



Disclaimer: For educational purposes only. We do not claim to treat, cure, diagnose, or prevent disease. These statements have not been evaluated by the Food and Drug Administration.

**ALOE VERA GEL:** To be used topically on your entire body. Designed using only high quality, non-toxic ingredients beginning with the purest Aloe Vera. When used topically it supports the healing of skin tissue, helps itching and soothes insect bites.

**CAPSULES:** Same great product, better value. Each capsule is equivalent in active ingredients to 2 fluid ounces of our 99.7% Aloe Vera Leaf Juice. Shape and small size for easy swallowing.

**4X CONCENTRATE:** One quart of our Extra- Strength Aloe Vera Juice is equivalent, in active ingredients, to a gallon of our original Aloe Vera Leaf Juice.

**SHAMPOO & CONDITIONER:** Shampoo made with 50% Aloe Vera Juice, Conditioner made with 60% Aloe Vera Juice. Designed using only high quality, non-toxic ingredients beginning with the purest Aloe Vera.

**Satisfaction Guarantee:**

Try any of our products risk-free. If you don't experience what you're looking for, you'll receive your money back, no questions asked.

**PET CRUMBLES:**  
 Glucosamine - Joint Health  
 Aloe Vera - Digestive Support  
 Probiotics - Gut Health and Beneficial for the Immune System  
 Yucca Schidigera - Skin and Coat Health

**HORSE PELLETS:** Pharm-Aloe Horse Pellets support a horses GI health, immune system, aids the balancing of stomach pH, supports normal detoxification and normal inflammatory response processes and reinforces cellular communication.

**ALOE GUT:** 97% Aloe Vera Gel that helps with colic conditions, GI health, comfort support and recovery support.



*Best aloe ever!*  
 — Bonnie K.



**AVAILABLE AT MOST LOCAL BULK AND HEALTH FOOD STORES**

ITEM NO.	QUANTITY	UNIT	DESCRIPTION
PA114		90 Capsules	Pharm-Aloe® Aloe Vera Leaf Juice Capsules
PAG8		8oz	Pharm-Aloe® 98% Aloe Vera Leaf Juice Gel
PAC32		32oz (1-QT)	Pharm-Aloe® AVL Juice 4X CONCENTRATE
EA25		25-LBS	Pharm-Aloe® Aloe Vera Leaf Horse Pellets
PAT60		14 oz.	Pharm-Aloe® K-9 Aloe Treats
PASH12		12 oz.	Pharm-Aloe® Aloe Shampoo
PACN12		12 oz.	Pharm-Aloe® Aloe Conditioner
EAG60		4 Pack	Pharm-Aloe® AloeGut

**To place an order contact your Tuckessee Distributor**

**Countryside Groceries  
 641-722-3046**

HEALTH/ HOME/CLOTHING



Our Price  
**\$139.99**

**Take 10% OFF**

**Ningxia Red 14-Day Reset Bundle**

INCLUDES:

- 51 ct. 2 oz. Single packets
- Wholesale Customer Account
- 1 FREE Oil



Our Price  
**\$215**

**Take 10% OFF**

**Ningxia Red Loyalty Bundle:**

INCLUDES:

- (4) Ningxia Red 750ml Bottles
- 30 ct. 2 oz. Single Packets
- Wholesale Customer Account
- 2 FREE Oils



Our Price  
**\$149**

**Take 10% OFF**

**4 pk. Ningxia Red**

INCLUDES:

- (4) Ningxia Red 750ml Bottles
- Wholesale Customer Account
- 1 FREE Oil



**BENEFITS OF PLACING AN ORDER WITH US:**

- 24% off future orders
- No obligation to reorder
- I can place your orders for you
- 4 pg. monthly newsletter
- Prompt Phone Service

**SPECIAL**  
Order for 3 months in a row and I'll pay your shipping

**YOUR CHOICE OF FREE GIFT!**

**1. FREE SHIPPING & TAX ON FIRST ENTIRE ORDER**

**2. FREE PRODUCT GUIDE & OILY LIFE GUIDE BOOK (Value \$20.00)**

(Mention Coupon with your order)

**For more questions and information contact:**

**Lizzie Ann - 330.231.8379 - 5437 CR 19, Millersburg, OH 44654**

**Are you struggling with...**

- ✓ Depression?
- ✓ Feelings of Hopelessness?
- ✓ Difficulty Sleeping?
- ✓ Anxiety?
- ✓ Marriage?
- ✓ Other Relationship Issues?



**Do you have a history of abuse or other wounds that continue to impact you today?**

If so, Woodside Rest and Springhaven continue to provide compassionate care and support in the following ways:

- One on one and group counseling with licensed professionals
  - Group counseling focused on developing more healthy thinking patterns, working through grief loss and forgiveness, improving communication, identifying family patterns and understanding your personality
- Medication management
- Equine Assisted Therapy
- Medical services
- Throughout the stay at Woodside Rest residents will enjoy a home-like atmosphere complete with 24/7 support alongside kind and respectful staff
  - Including nutritious meals, group devotions, recreational activities, medication distribution, and opportunities to stay connected with loved ones through writing letters, phone calls, and visits

**For more information please contact our Amish Liaison, Dennis Keim at (330) 231-0099**

Feet, Ankles, Knees, Hips, Back...**HURT?**  
**STOP YOUR PAIN NOW!**  
A NATURAL APPROACH TO HEALTH



World's Best 1-year warranty  
**MASSAGING INSOLES®**  
BY BESTSOLE INC.

1 pair **\$59.95**  
2 pair **\$54.95** ea.  
3 pair **\$49.95** ea.  
tax & free shipping included

Mary Byler • 270.922.8214  
2240 Coal Bank Hollow Rd • Hawesville KY 42348

Made in USA

Relief From: Heel Spurs • Low Back Pain • Hot Burning Feet • Fibromyalgia  
Morton's Neuroma • Plantar Fasciitis • Bunions • Calluses • Diabetes • Varicose Veins



Reindeer eyeballs turn blue in winter to help them see at lower light levels. (They're golden-colored in summer.)

No other mammals are known to have this ability.

# Sleep better. Every season of the year.

# Bearaby



Bearaby weighted blankets are rated at **4.8 out of 5 Stars** from dozens of verified "Busy Beaver" Bearaby users.



**Did you know**, a Bearaby gives you the weight effect of a comforter (and more), but retains almost no heat, so you can sleep better in the summer as well? Simply use it over the top of a linen, and enjoy a deep, restful night of sleep!



## Natural deep sleep

Scientific research shows that sleeping under an evenly distributed weight brings about a deeper, more natural sleep cycle



## Peace of mind





The sensation of being cuddled lowers stress and anxiety by reducing cortisol, making you feel calm and relaxed



## Joyful feeling

Being gently cocooned in a comforting weight increases serotonin, making you feel positively happy.

Our handmade **Cotton Napper** is a breathable, knitted weighted blanket to help you fall asleep faster and feel calmer, naturally. Designed for individual use, your Napper should be about 10% of your body weight. Not designed to add warmth. **Made of 100% organic cotton.**

-  Asteroid Grey (AG)
-  Moonstone Grey (MG)
-  Driftwood (DW)
-  Blue Spruce (BS)
-  Midnight Blue (MB)
-  Cloud White (CW)
-  Morning Matcha (MM)
-  Evening Rose (ER)

- 10 lb (40" x 64"): **\$220**
- 15 lb (40" x 72"): **\$299**
- 20 lb (45" x 72"): **\$325**
- 25 lb (48" x 72"): **\$365**



**FREE SHIPPING!**

Also Available: Queen Size, King Size, Kid's Nappers, and Cooling Nappers

**\*NOTICE: It is best to call before ordering. Not all colors are currently in stock in all sizes.**

Item/ Size	Color	Qty	Price EA	Subtotal
For Ohio orders add 6.5% Sales Tax				
<b>TOTAL</b>				

### TERRACLAY™ Dreamer Weighted Sleep Mask



Seashell (SS)



Sweet Lavender (SL)

**\$89**

Call Neva: **(234) 301-7937**

or Mail with Payment: **Whisperwood Enterprises, PO Box 247, Fredericksburg OH 44627**

## Start your BEARABY therapy today!



HEALTH/ HOME/CLOTHING

# Be Prepared for **CANNING SEASON**

## The peeler that peels, Pears, Peaches, Oranges, Kiwis, Apples, Potatoes!



### Available at these retail stores

- ◆ **King Sales & Service** Ph# **717-351-9234** | K5466 Seldomridge Rd, New Holland, PA 17557-9574
- ◆ **Eash Sales** Ph# **260-768-7511** | 1205 In-5, Shipshewana, IN 46565
- ◆ **Countryside Sales** Ph# **260-593-0759** | 6870 S 1000 W, Topeka, IN 46571-9404
- ◆ **Shady Crest** Ph# **217-259-3510** | 2046 Cr 1800e, Arthur, IL 61911-6062
- ◆ **Himrod Housewares** Ph# **315-536-8446** | 1139 Briggs Spicer Rd, Himrod, NY 14842-9739



## Call **330-390-2992** **The Blooming Thistle**

31527 Township Road 227, Fresno OH 43824

**Price \$198.25**  
**+ \$10 Shipping**  
*(OH residents add 7% sales tax)*





# Make It Shine.... The Easy Way!



Cleaners that work on everything including: Buggies, Laundry, Kennels, Equipment, and so much more!



### ALL PURPOSE CLEANER

Heavy duty soap cleans RVs, boats, awnings, tractors, lawn mowers, vinyl siding, vehicle interiors, fabrics, carpets, and clothing.

1 Gallon Jug.....\$ 35.00  
5 Gallon Bucket .....\$152.00

### ONE PUNCH CLEANER

An ecofriendly, biodegradable, aggressive vehicle cleaner. Excellent for heavy equipment, farm equipment and shop floors. *Do not use on anodized or mirror polished surfaces.*

1 Gallon Jug.....\$ 35.00  
5 Gallon Bucket .....\$152.00

### DEGREASER CLEANER

Our Degreaser is formulated to cut through oil without using harsh chemicals. Remove oils and heavily soiled grime from engines, concrete garage and shop floors, commercial kitchens, and areas around your house.

1 Gallon Jug.....\$ 35.00  
5 Gallon Bucket .....\$152.00

### BUGGY WASH & HARNESS CLEANER

Our foaming soap solution will eliminate dust and dirt from your buggy and equine equipment.

1 Gallon Jug.....\$ 35.00  
5 Gallon Bucket .....\$152.00

### KENNEL CLEANER

Highly effective cleaning product for dog kennels. Contains essential oils, which will eliminate odors and leave your kennel with a clean scent. *Not for direct use on animals.*

1 Gallon Jug.....\$57.00  
5 Gallon Bucket.....\$262.50

### BEARCAT TRUCK CLEANER

Our heavy duty alkaline soap attacks road film, bug residue, soot, oils and grease. Our product is polish safe and doesn't etch aluminum, so your truck will have that long-lasting shine!

1 Gallon Jug.....\$ 35.00  
5 Gallon Bucket .....\$152.00

Distributed by:

**Keystone Sales**

717-715-3498  
332 Hollow Road  
Quarryville, PA 17566

Dealer inquiries welcome.  
Call for wholesale pricing.

# Char GOLD

**PREMIUM  
HARDWOOD  
Lump  
Charcoal**

**\$26.95**

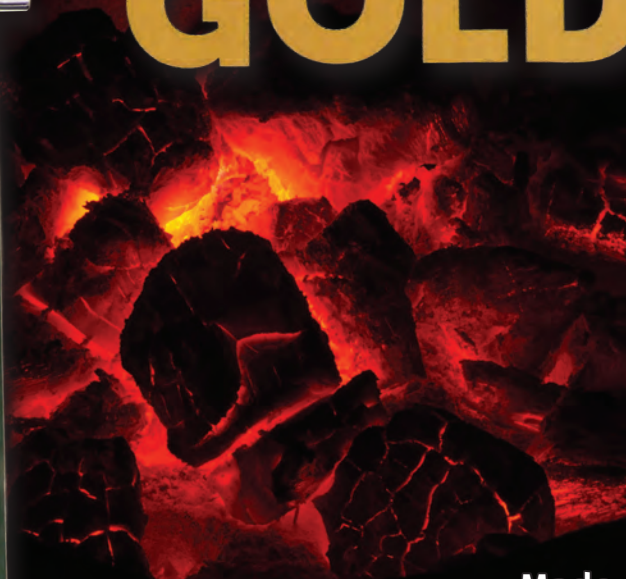

- Bigger chunks that last longer
- Easy to light
- Gets hot quicker
- Stays hot longer
- Superior product
- Made out of recycled wood

— Green Matters —

HEALTH/ HOME/CLOTHING

# BEVANDA®

INTRODUCING

# VERGE 50



## 15% OFF

WHEN YOU ORDER BEFORE 06/30/26

Price goes from ~~\$339~~ to ~~\$399~~ when pre-order ends

### PRE-ORDER TODAY

**717-687-7436**

#### EASY TRANSPORT



#### MAGNETIC ICEPACKS



#### EASY CARRY



#### AVAILABLE IN



**WHITE**



**BROWN**



**BLACK**

**"Get Ready for Summer: Summer Essentials!"**



**MayKo 8" Oscillating Clip Fan**  
#3887 | \$53.75



**MayKo Dual Air Compact Fan**  
#3926 | \$19.95



**MayKo Reusable Water Balls**  
#3574 | \$12.95 / pk of 6



**8" Glow Sticks**  
#3131 | \$13.50 / 100 cnt



**MayKo Pickle Ball Paddle Set**  
#4056 | \$79.90



**Dual Nozzle BBQ Lighter**  
#3500 | \$70.00



**Solar Motion Sensor Light**  
#4036 | \$16.60



**Remote Control Airplane**  
#3766 | \$42.00



**MayKo 5-Day Forecast Station**  
#4035 | \$59.95  
(must be plugged into power source for display to be lit full time)



**MayKo Tactical Pen Light**  
#2452 | \$8.95



**MayKo Mini Pen Light**  
#3361 | \$7.90



**MayKo Rechargeable Mini Pen Light**  
#3819 | \$19.95



**Mosquito Repellent Bands**  
#3624 | \$1.40



**600 Lumen Bike Head Light**  
#2413 | \$42.25



**Clear Lens Red LED Tail Light**  
#2411 | \$12.95



**MayKo Reversible Safety Vests**  
Kids to Adult Sizes, \$39.95 - \$59.95

**Ask for These Items at Your Local Retailer!**

In Stock at MayKo & Ready for Immediate Shipping!



**MAYKO PRODUCTS LLC**  
Connections to elevate your business success.

**Unlock New Opportunities for Your Retail Business!**

Are you a retailer looking to expand your product offerings? Contact us today to discover exciting new opportunities with MayKo Products!

**Phone:** 866.432.2385 | **Fax:** 330.556.4542

These products are also available from Valtea Variety. Call 330.331.2035 to inquire. Valtea charges listed prices + a \$10.00 flat rate shipping fee per order.

**Request your free wholesale or mail order catalog today!**

Note: MayKo is wholesale only, while Valtea is mail order only.

HEALTH/HOME/CLOTHING

# DOUBLE THE REEDS - DOUBLE THE SPRINGTIME SOUND



## Double Reed Harmonicas

### CONCERTO STEEL

Now with stainless steel reeds. New reed plates are available in all keys and are compatible with older style.

The Concerto Steel is a high grade octave-tuned double-reed diatonic. The notes are arranged exactly like on a 10-hole diatonic. It has a divided comb made of maintenance-free plastic and profits from the approved stainless steel reeds well known for durability and tuning stability. Measures 4.9" long.

Keys are listed from lowest to highest:  
A, Bb, B, C, Db, D, Eb, E, F, HG



Reg. Price \$130.00 ea. ppd

**Sale Price \$110.00 ea. ppd** (now thru June 30th)

Reed Plates - All keys. \$85.00 ea. ppd



### SEYDEL

HARMONICAS - HANDMADE IN GERMANY SINCE 1847

**New double reed harmonica from Seydel.** Now with a thinner comb making it thinner overall with rounded holes for a more comfortable feel. Fully valved to make it airtight so it will blow easier. Tuned like the Concerto, Autovalve and Knittlinger harmonica.

STAINLESS STEEL REEDS for maximum durability and tuning stability.

Keys are listed from lowest to highest:  
A, Bb, B, C, Db, D Eb, E, F, HG

### SHAMROCK STEEL

**NEW**



\$130.00 ea. ppd

Reed Plates - All keys. \$85.00 ea. ppd

**GOOD SELLER**

### BUSHMAN HARMONICAS

### KNITTLINGER

Introducing the loud and lively, quick and nimble, ultra-responsive Knittlinger.

It sounds like an accordion, but it's a double reed, Knittlinger octave harmonica with 10 holes and 40 reeds, in the traditional Richter note arrangement. It features a forever lasting, not going to warp, plastic comb, and a thin profiled, comfortably beveled, slick, go-fast, chrome-plated mouthpiece.

Keys: LA, LBb, LC, LD



\$100.00 each ppd

### Other Harmonicas Available

- |                     |                        |                      |
|---------------------|------------------------|----------------------|
| <b>Hohner</b>       | Rocket Amp             | Super Chromonica     |
| Bluesband           | Rocket                 | CX-12 Chromatic      |
| Big River           | Rocket Low             | Clearly Colorfuls    |
| Old Standby         | Golden Melody          | Hoodoo Blues Sets    |
| Marine Band         | Double Sided Echo      | Piedmont Blues Sets  |
| Thunderbird         | Comet                  |                      |
| Special 20          | Unsere Lieblinge       |                      |
| <b>Bushman</b>      | Delta Frost Collection | Mini Harmonica       |
| Blues Shifter       | Gentle Monster         | GM648 Song Chromatic |
| Roundhouse          | Evolution              | JDR Quartz Chromatic |
| Dinky               | Ninja                  | Evolution Chromatic  |
| John Lee Collection | Amazing 20             |                      |
|                     | Blue Steel             |                      |



Major Diatonic



- Club Steel
- Tremolo Sailor Steel
- 1847 Lightning
- 1847 Classic Low
- Blues Session Steel
- After Work Edition Set



- Easy Rider
- Folkmaster
- Bluesmaster
- HarpMaster
- Overdrive
- Promaster
- Promaster Valved
- Pipe Humming
- Tremolo 2 Timer

### Mail orders to:

15316 HAYES ROAD  
MIDDLEFIELD, OHIO 44062

Ohio residents add 6.75% sales tax.

Mail order preferred.



### Call to Order:

**440-632-7123**

FREE CATALOGS AVAILABLE  
Wholesale inquires welcome.

# Shop the Callie Bowl Collection for all your Wedding needs

\$31 - 4 piece set. \$8 Shipping

OFFER ENDS 5-31-26



Perfect for Lunch Boxes or Leftovers

Call For Pricing for Large Orders and Server Gifts

- Collapsible, stores easily
- Lids fit tight, no leaking
- Withstands extreme temperatures up to 300 degrees
- Reduce plastic use
- Silicone is the healthier choice



Contact - 56865 CR 2 Fresno, OH 43824 | 330 440 3395

HEALTH/ HOME/CLOTHING



I Like the Way My Dad Shaves

The Henson Shaver

The Healthier Way To Shave

Save Plus Keep this world a cleaner place by using a shaver that has no plastic disposables.



Over 10,000 Five Star reviews from satisfied people that are using the Henson Shaver.

Call 330-600-8529

# Childrens DOLL HOUSE

Teaching Housekeeping  
Through Play



♥ It's amazing!  
My girls spend hours  
every day playing with  
their new Doll House.



**\$150**  
Plus \$22  
shipping

**STREAM VALLEY SALES**

Stream Valley, 2973 TR 182, Baltic OH 43804

**Call 330-432-5137**

## NOW DRY SWEATY SHOES QUICKLY.

**9 TIMES QUICKER THAN AIR DRYING.**

### ORIGINAL PEET SHOE AND GLOVE DRYER



Item: M97  
**\$129.99**

- ✓ Power Source 110V
- ✓ Energy efficient: Uses less energy than a low wattage light bulb!
- ✓ 25 year warranty
- ✓ Made in the USA
- ✓ Glove attachment included

PEET Dryers work silently, you won't hear any air blowing or fan noise. Dries 9 x faster than air drying. Simply turn it on and leave it! Enjoy!

*Father's Day Gift*

Stream Valley Sales, 2973 TR 182, Baltic OH 43804

To Order Call 330-432-5137 or Mail This Form

Name \_\_\_\_\_  
Address \_\_\_\_\_  
City St, Zip \_\_\_\_\_  
Phone \_\_\_\_\_

Item number \_\_\_\_\_ Qty \_\_\_\_\_ Price \_\_\_\_\_  
Shipping for 1 Dryer... (USA order)..... **\$17.00**  
OH residents add 7% sales tax ..... \_\_\_\_\_  
Total..... \_\_\_\_\_

# STOJO Silicone Collapsible Food Storage Bowls

Making the Kitchen  
a Better Place  
With Less Plastics.

Finally a BPA Free Bowl for Food  
Double Strength Durability  
Collapsible for Small Space Storage  
Freezer/Fridge/Ice Box Friendly  
Perfect Bowl for Lunch Box  
Liquid Tight



Now I have peace of mind.  
Good Bye Plastics

To Order Call 330-440-3395  
James & Sarah Beechy  
56865 CR 2  
Fresno OH 43824

HEALTH/ HOME/CLOTHING

Helping what matters.....Make  
This world a better place with  
no plastics.

## Safe Silicone Wrap For Food



Feel Good About Reusing  
Wrap Again.

BPA Free (no toxins)  
Freezer Friendly  
Lunch Box Friendly

To Order Call  
330-440-3395





Joya

Bye-bye heel spurs!

Step into innovation for your health - enjoy pain-free walking and standing.

FOREVERFOAM®

Swiss Sole Technology



Can be purchased at:

JOYA Footwear

5765 Meadville Road, Gap, PA 17527

Phone 717-475-4191

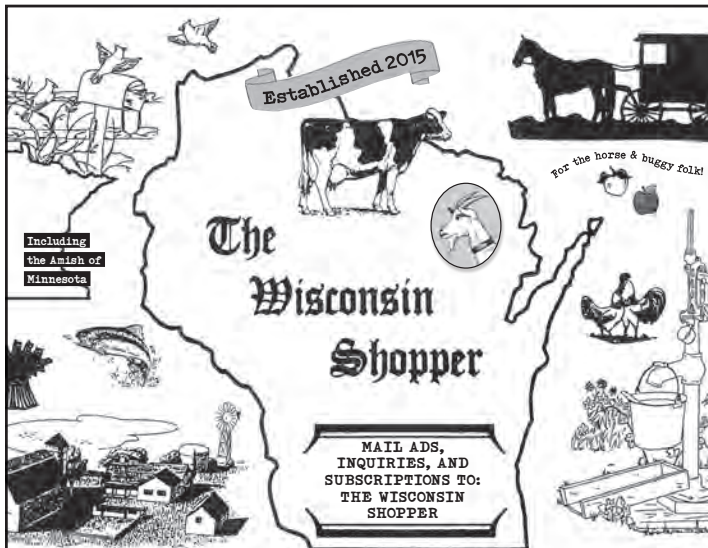

The Wisconsin Shopper is an advertising paper published weekly and mailed free to the horse & buggy groups—approx. 6500 Amish and 600 Mennonite homes—every week! New Subscriptions of \$50 per year are available to Amish outside of Wisconsin and Minnesota, and to non-Amish. Write for our Ad Rates.

**The Wisconsin Shopper**

12608 Orr Rd., Fennimore, WI 53809

#1 Bestseller on amazon

the boy in the window

Order While Supplies Last

Growing up as a Ragland boy meant a one-way street to nowhere-until the Mennonites moved to town.

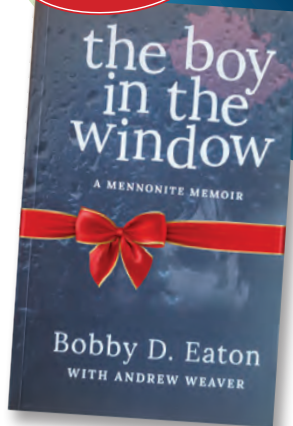

Order Form

Name \_\_\_\_\_  
 Address \_\_\_\_\_  
 \_\_\_\_\_ City \_\_\_\_\_  
 State \_\_\_\_\_ Zip \_\_\_\_\_  
 Phone \_\_\_\_\_

Price for 1-19 books is \$19.99 each, free shipping  
 Price for 20 + books is \$11.95 each, free shipping  
 Qty Books \_\_\_\_\_ Total \$ \_\_\_\_\_

Mail form to: Pure Path, P.O. 151 Box  
 Emmitsburg MD 21727 Or call 888-401-7747 to place your order.

Pure Path, P.O. 151 Box Emmitsburg MD 21727 • 888-401-7747

HEALTH/HOME/CLOTHING

ANABAPTIST FINANCIAL

You are  
INVITED!*Deacon & Trustee***SEMINARS****LOCATION:****HILLCREST MENNONITE COMMUNITY CENTER**

23098 State Route M, Memphis, MO 63555

**Tuesday, June 23, 2026****TIME:** 8:00 AM – 4:00 PM**The Role of the Church Brotherhood**

· Lydell Martin; Reinholds, PA

**Teaching Financial Responsibility**

· Leland Ulrich; Grandview, TX

**Handling the Church Funds**

· Carl Hoover; Gorin, MO

**Recognizing and Connecting with the Struggling**

· Daniel Miller; Chariton, IA

**Nurturing Stewardship Discussions**

· Clyde Zimmerman; Altoona, PA

**Envy: Who Can Stand Against It?**

· Carl Hoover; Gorin, MO

**LOCATION:****CAM KY SORTING CENTER**

3330 Old Railroad Ln, Guthrie, KY 42234

**Thursday, June 25, 2026****TIME:** 8:00 AM – 4:45 PM**Consider the Lilies**

· TBD

**Setting Your House in Order**

· Richie Lauer; Hillsville, VA

**Moved With Compassion**

· Kevin Coblentz; Oakland, MD

**Giving Jesus' Way**

· James Miller; Crossville, TN

**Brotherhood Assistance or Welfare?**

· Joe Kauffman; Burkesville, KY

**Nurturing Stewardship Discussions**

· Clyde Zimmerman; Altoona, PA

**Transparency and Confidentiality**

· Paul King; Gordonville, PA



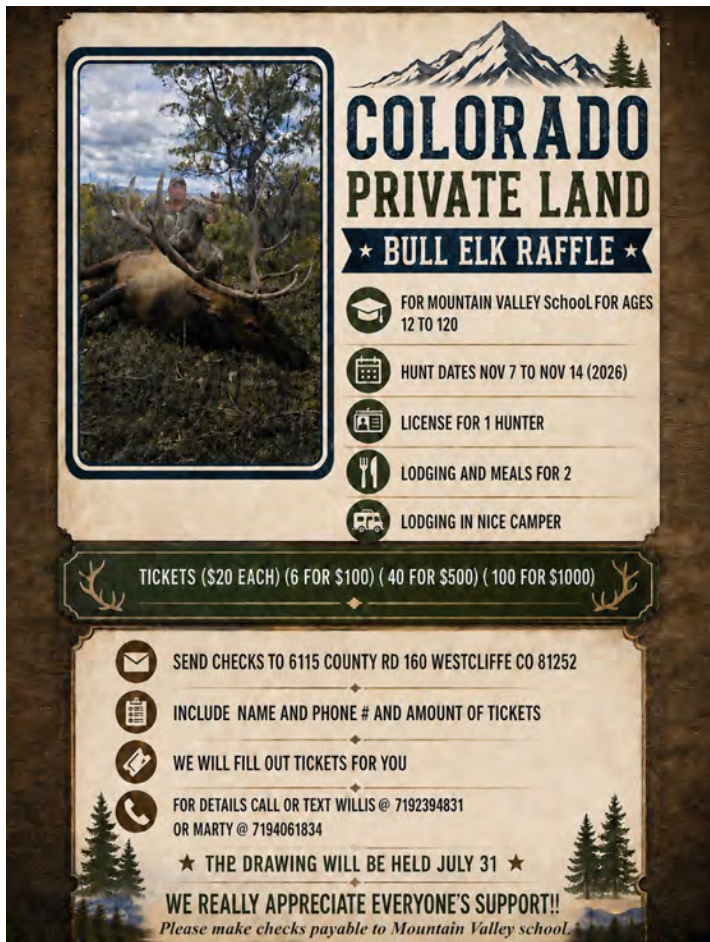

Please register by June 5 so we can be sure to have adequate resources.  
When you register, please let us know if your wife is planning to come with you.

**Register Today!**Phone: 267-368-4628 | Online: [afweb.org](http://afweb.org) | Email: [seminars@afweb.org](mailto:seminars@afweb.org)





## COLORADO PRIVATE LAND

### ★ BULL ELK RAFFLE ★

-  FOR MOUNTAIN VALLEY School FOR AGES 12 TO 120
-  HUNT DATES NOV 7 TO NOV 14 (2026)
-  LICENSE FOR 1 HUNTER
-  LODGING AND MEALS FOR 2
-  LODGING IN NICE CAMPER

TICKETS (\$20 EACH) (6 FOR \$100) (40 FOR \$500) (100 FOR \$1000)

-  SEND CHECKS TO 6115 COUNTY RD 160 WESTCLIFFE CO 81252
-  INCLUDE NAME AND PHONE # AND AMOUNT OF TICKETS
-  WE WILL FILL OUT TICKETS FOR YOU
-  FOR DETAILS CALL OR TEXT WILLIS @ 7192394831 OR MARTY @ 7194061834

★ THE DRAWING WILL BE HELD JULY 31 ★

**WE REALLY APPRECIATE EVERYONE'S SUPPORT!!**  
*Please make checks payable to Mountain Valley school.*



# LAND AUCTION



## 46.37 AC± | 2 TRACTS GRANT CO, WI

### 6/9/26 AT 11 AM

**AUCTION HELD AT  
LANCASTER COUNTRY CLUB  
5 GOLF RD  
LANCASTER, WI 53813**

IN COOPERATION WITH WHITETAIL PROPERTIES REAL ESTATE, LLC  
KYLE SCHULTZ, AGENT: 608.406.4609

## RANCHANDFARMAUCTIONS.COM

IN COOPERATION WITH WHITETAIL PROPERTIES DBA RANCH & FARM AUCTIONS | Jeff Evans, WI Broker for Whitetail Properties Real Estate, LLC, WI Lic: 57567-90 | Joe Gizdic, Director, Ranch & Farm Auctions, 217.299.0332 | Kyle Schultz, WI Land Specialist for Whitetail Properties Real Estate, LLC, 608.406.4609 | Cody Lowderman, WI Auctioneer License: 2632-52

# ONLINE AUCTION ONLY

## ESTATE OF SUSAN TOBLER AND RETIREMENT OF WILLIAM (TOBY) TOBLER. CASS COUNTY MISSOURI

**ONLINE BIDDING ONLY**

**BIDDING STARTS TO CLOSE THURSDAY, JUNE 11TH, 2026 AT 6:00 PM**

World class farrier, Toby Tobler has retired and is selling his anvils, farrier and blacksmith tools, forge, and trip hammer. Plus saddles, horse tack, round pen, trailer, wooden duck decoys, Coca Cola collection, plus hundreds of other items.

**WEBB & ASSOCIATES**  
STILWELL KS  
AUCTIONEERS & APPRAISERS

**WEBB & ASSOCIATES**  
STILWELL KS  
AUCTIONEERS & APPRAISERS

Bid at [www.dlwebb.com](http://www.dlwebb.com)

Auctioneer: Dave Webb  
Phone: (913) 244-1011  
[www.dlwebb.com](http://www.dlwebb.com)



For online bidding go to [www.dlwebb.com](http://www.dlwebb.com)

**ONLINE AUCTION ONLY \*\*\*\* ONLINE AUCTION ONLY \*\*\*\* ONLINE AUCTION ONLY \*\*\*\* ONLINE AUCTION ONLY**







**Open House & Inspection: June 10th from 5:00 to 7:00 p.m. Item Pick Up: June 13th from 9:00 a.m to 1:00 p.m.**

AUCTIONS/BENEFITS/REAL ESTATE

# Phone Bid Business Auction

Taking Bids Until **Tuesday June 23rd, 2026** Ending at 6:00 PM

**Great Side Business!**

Located: Mineral Springs Road | Greensfork, IN

## Carriage Repair Business To Include:

2011, 7' x 14' V nose trailer, Brake press, New Milwaukee Packout Set, Milwaukee Cordless Tools including: 3/8 impact, 1/4 impact, 1/2 drill, 4-1 drill, grinder, hackzall, router, vacuum cleaner, staple gun, batteries: (2) 5AH 18V, (1) 5AH 12V, (1) 4AH 12V, (4) 2AH 12V Hand Tools: Milwaukee Wrench set, Socket sets, metric and sae, Thomas & Betts Wire Stripper, Crimper, etc. Plus more, too numerous to mention!

## Inventory Includes:

Axles, Brakes, Ezestop, Brake Parts, lights, large selection of stainless steel fasteners. Approximately \$30,000 in inventory! This business includes everything to repair brakes, lights, etc.

**Owners: Steven & Rachel Beiler**

Owner is willing to train.

You can call and leave a bid anytime, where we keep high bid on voicemail 765-591-6233 until June 23, where we will **FINALIZE OVER THE PHONE AT 765-591-6233 AT 6:00 PM.**

**Starting Bid: \$25,000** Sells Absolute!

To inspect business or with questions, call Jake at 765-591-6233.



TERMS: 10% down (Non-refundable) with balance due at closing. Closing within 30 days with possession given at closing. Any announcement made evening of the auction take precedence over printed matter. Seller has the right to reject any or all bids.



**Jake Stoltzfus**  
License # IN: AU10700049  
(765) 591-6233

AUCTIONS/BENEFITS/REALSTATE

# LAND & HOME AUCTION

## Flemington, MO - June 27 - 10am

Auction conducted for Mr. & Mrs. James M. Sauder  
3200 MO-83, Flemington, Missouri, 65650

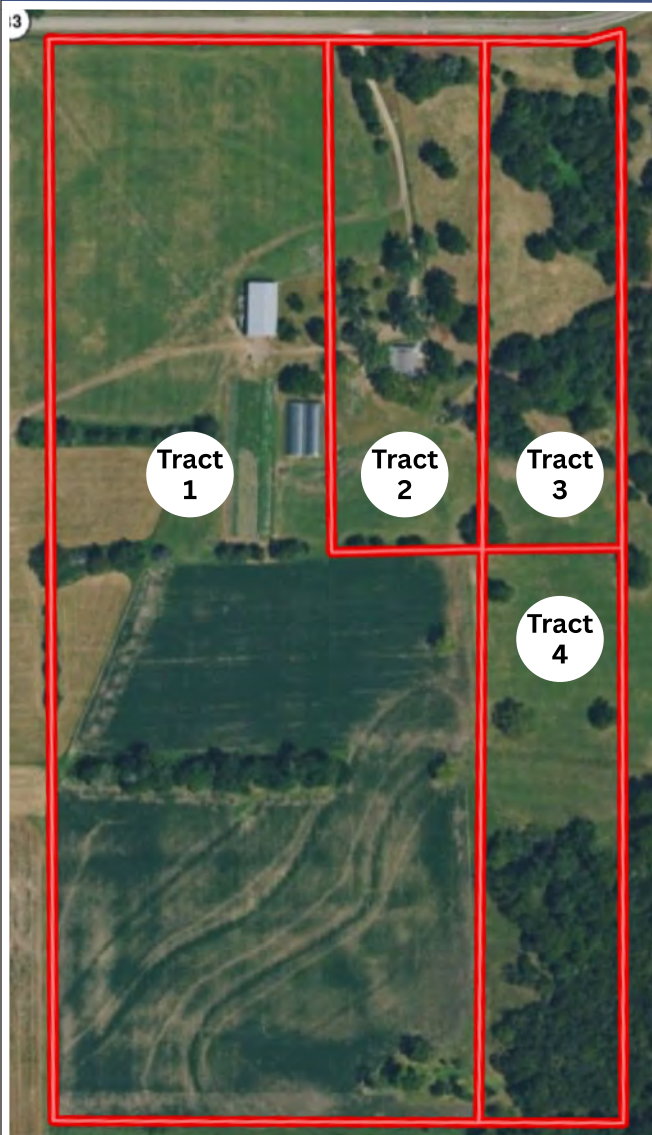

**Tract 1** - Consists primarily of 28.0± productive row crop farmland with excellent agricultural potential and income-producing capability. Goodson silt loam, 1 to 3 percent slopes. Class 2 soils that have been producing outstanding corn crops.

**TRACT 2** – Custom Home on 6.0± Acres  
This premier tract features a beautiful custom-built -full walkout basement home constructed in 2023 situated on approximately 6± acres. The home offers approximately 3,592 square feet of finished living space thoughtfully designed for comfort, functionality, and country living.

**Tract 3** - consists of approximately 5.0± acres of mixed timber and pasture offering an excellent small acreage tract with multiple potential uses.

**Tract 4** - consists of approximately 6.0± acres of mixed timber and pasture offering an excellent small acreage tract with multiple potential uses.

The greenhouses and equipment will be sold separately immediately following the land auction.

*This property is being sold in 4 separate tracts allowing buyers the opportunity to put together what they wish!*



- Auction Terms & Conditions**
- Successful bidders will be required to sign a real estate purchase agreement immediately following the auction.
  - A 10% non-refundable earnest money deposit is due immediately at the conclusion of the auction.
  - Balance of purchase price due at closing within 30 days.
  - Property is selling subject to seller confirmation.
  - Seller will provide marketable title at closing.
  - Taxes will be prorated to the date of closing.
  - Announcements made day of sale take precedence over all prior advertising.
- For additional information, contact Randie Landwehr with **United Country Farm & Home Sales**.

**Randie Landwehr**

**660-223-2939**

Call me with any questions  
KS & MO Real Estate Broker



## Buy Direct Save \$

- Toilet Paper
- Paper Towels
- Shop Towels
- Energy Drinks
- Diapers

Cheese • Organic Food • Frozen Food

HBA • Banana Boxes • GM • Laundry Detergent •

Sweatshirts • T-Shirts • Baseball Caps

Bear Loads Available

Now through December 31, 2025

\$500. off truckload orders excludes Bear loads

**BARGAINMAX, INC.**

**SALES: 704-612-9794**

**Doug: 704-277-8007**

**FOB Charlotte**

All items above can be in/out /short dated

The Busy Beaver of Tuckesse  
and Beyond™

P.O. BOX 3

Charm, OH 44617

Classified Ads

(by mail)

P.O. Box 3046

Clarksville, TN 37043

Display Ads, Subscriptions

Phone: 800-886-2704

**Volume 8, No. 6**

**May 22, 2026**

THE BUSY BEAVER™ travels to over 17,000 Plain homes throughout KY, TN, IA, IL, MO, MS, MN, AR, TX, WI, OK, KS, CO, MT, ID, NE and WY. It is a weekly publication, mailed FREE to Old Order Amish patrons as an advertising source to intertwine our communities. All others may subscribe to this publication for \$50.00 a year. This rate is to USA residents only. Copyright© Busy Beaver Publications, LLC™ 2016-2026



**SHADY LANE  
Curtains LLC**

# 2-3 Week Lead Times



## Maximum Protection in the Winter

Professionally Installed

DIY Kits Available



**Curtain Experts**

**Most Durable**

**Longevity**



**Call Us Today: 717-690-2003**