

VOLUME 10, No. 20 • February 14, 2026

Save up to **75%**
Compared to
Custom Cabinets

717-844-2190



KEA
KABINET
SOLUTIONS

Solid wood Cabinets
Shipping Available



Scan for a Better
Beaver Experience

Delivered to over 16,610 homes! EVERY 7 DAYS!

Exposure for your products - Like no other...

Waterloo Valley School Raffle

Tickets are **\$20.00 each** or **6 for \$100.00**

Drawing will be held on **March 6, 2026.**
Need not be present to win.

Call or mail for tickets
Mervin Wengerd 270-576-6750
198 Meadow Ridge Ln.
Horse Cave, KY 42749

Win a 5 day/4 night stay in a 14 person cabin at the **Great Smoky Mountains** in Gatlinburg, TN August 17-21, 2026 plus \$1,000 cash *(date flexible)*



Waterloo Valley School Raffle

Name: _____
Address: _____
Phone: _____

20 year old Darren Swarey is currently residing at **Whispering Hope Retreat**

Donations Needed

Please send donations to

Ephrata Bank,

615 E Lincoln Ave, Myerstown, PA 17067

Make checks payable to: Darren Swarey

Funds will be handled by the custodian on the account.

Thank you



SHADY LANE
Curtains LLC

2-3 Week Lead Times



Professionally Installed



Curtain Experts | Most Durable | Longevity

DIY Kits Available



PROUDLY PARTNERING WITH



Serving Michiana with Fast Lead Times



Call today for short lead time installations
michianaequipment.com | 547-642-4768

Editor's Corner

Good day everyone,

We're having calm winter weather. Yesterday, the sun shone brightly on the pure, white snow making a peaceful scene. Is this the calm before the storm? I've heard people say there's a huge snowstorm headed our way this week. I guess we'll wait and see.

My plans are to head south next week to see if I can find some sunshine, palm trees, warm weather, and lots of water. I'm not sure if I'll be able to find the warm weather as it sounds like Florida has had quite a bit of chilly weather too.

Rhoda Miller

*Happiness is not the absence of problems,
it's the ability to deal with them.*

Submit a Classified Ad

Helping you sell anything from A-Z,

See Page

7

SCHROCK OVERHEAD DOOR
PAGE 117

360 HUNTING BLINDS
PAGE 193

CHUPP AUCTIONS
PAGES 62-64

Rosie's Roost
Premium Organic Coffee
PAGE 92

SPRIGS
Now Hiring
Full-Time Sales Associates
PAGE 71

THE CANADIAN KIND
PAGE 159



Hauling Firewood
Just Got Easier



- Features:**
- Honda GXV160 Engine
 - 6 speed peerless transmission
 - 20" drive tires
 - 525 pounds or 15 cubic feet
- Hauling capacity**
- 1.8 MPH reverse
 - 342 pound dry unit weight
 - Pivoting rear axle
 - 6 3/4" ground clearance
 - 6 MPH forward

Compatible with SideKick
Spreader and Sprayer

CONTACT A STOCKING DEALER

IOWA
Gingerich Logging
Bloomfield, IA 641-722-3414

ILLINOIS
GDS Enterprises
Arthur, IL 217-943-9681
Whiteside Sales & Service
Morrison, IL 815-651-4294

INDIANA
Fry's Repair Shop
Topeka, IN 200-593-3228

PENNSYLVANIA
Blue Mountain Small Engine
Newburg, PA 717-423-5558
Sensenig's Repair Shop
Ephrata, PA 717-354-8122

OHIO
Charm Engine
Millsburg, OH 330-897-2190
First Quality Power Place
Middlefield, OH 440-632-5069

New Bedford Engine
Fresno, OH 330-897-2190
Ray's Repair
Middlefield, OH 440-834-1107

Winesburg Lawn & Garden
Dundee, OH 330-359-0230
Yoder's Small Engine
Babco, OH 330-852-9080

BECOME A DEALER 833-893-3254



FAMILY OWNED & OPERATED

BEAR VALLEY CABINS

STEVEN YODER
231) 229-2699
8566 N 8 MILE RD
LAKE CITY, MI 49651



CHIMNEYS
• 304 GRADE STEEL
• CODE APPROVED
• FIRE TESTED
• MOST ACCESSORIES IN STOCK

WWW.BEARVALLEYCABINS.COM

• Closed-Cell Foam Insulation
• Blown-In Attic Insulation

Nelson's SPRAY FOAM, LLC

Nelson Schmucker
1700 N. Ainger Rd. • Charlotte, MI 48813
517-983-0954
Start Saving Today ~ Use Spray Foam

LOCK N LUBE®

Save time. Save money.
Save grease.



24 Interchange Drive • West Lebanon, New Hampshire 03784 • USA

ORDER ONLINE OR CALL US TODAY! | WWW.LOCKNLUBE.COM | 603-795-2298

Page One Group **Business Cards**

Let us Design and Print yours!

Qty	Black & White		Color	
	1-Sided	2-Sided	1-Sided	2-Sided
250	\$32.00	\$38.25	\$39.00	\$52.00
500	\$41.00	\$51.00	\$46.00	\$66.00
1000	\$50.00	\$65.00	\$65.00	\$95.00

*Plus shipping. Design an additional \$45/hour—Minimum \$25. Standard Size, 100#, Cover Paper Stock. All prices subject to change.

740-397-0262
19270 Scott Rd.
Mt. Vernon, OH 43050
orders@pageonegroup.net

UP NORTH Spray Foam Insulation

Lewis Mast – Owner • Hale, MI
Call for your free estimate
989-218-2006

Creekside POLY FENCING

16' x 5½" x 1'
\$55.00/board
Various size posts
Call for pricing

HDPE Plastic • Low Maintenance
No Painting • No Sagging

Olen Yoder
1275 S 1100 W • Middlebury, IN 46540
Ph 574-327-3536 • Fax 574-825-2377

Levi's Custom Benchwagons



FIBERGLASS BOX & ROOF
POPLAR BENCHES
CUSTOM INTERIOR
COMPLETELY FURNISHED
OR PARTIALLY FURNISHED

LEVI & ELSIE MILLER
51500 CR 29
BRISTOL, IN 46507
(574) 825-3083

Your Ad Could Be Here

Advertise in the Busy Beaver of Michiana™

Call Faron
574-501-5105

TUPPERWARE

CHRISTINA MILLER
5035 W 200N
SHIPSHAWANA, IN 46565
PHONE NUMBER
(260)336-4828

HELP YOU WITH ALL YOUR TUPPERWARE NEEDS

LJS GUTTER SOLUTIONS

Gutters • Guards • Cleaning • Free Estimates

Loren Schrock
54641 SR 13
Middlebury IN 46540

260-499-1104
lorenjschrock95@gmail.com

DISORGANIZED BOOKKEEPING???

Why not try something different...

something better... dare I say this could actually make office work enjoyable!

Try the One Write Check System!

Write and record in one step. No more costly errors or forgetting to record your purchases
A tried and true manual bookkeeping system that continues to outperform all other methods!

We also design, print, & sell....



Self Seal
Starter Kit Special!
Call for pricing & details

Sales Books

Proposals

Invoices

Quickbooks
Checks



Deposit
Tickets



....and much more!
Call for a catalog.



Name & Address Stamper

Imprint area/size 2-1/4" wide x 7/8" high
Up to 4 lines of ANY custom wording.

\$36.00 each + Sales Tax

See bottom of page for Sales Tax Rate

Order by Mail or Phone. Payment required with order.

Add a \$10 upcharge for Signature or Logo on Stamper.

Writing Style Options

Century Gothic Bold Segoe Script Bold Hobo

PERSONAL CHECKS

Marble Checks 4 images per design on the all checks except the marble colors.

Black Leather or
Black Vinyl also available

Matching CheckBook Covers



Green, Blue, or Burgundy

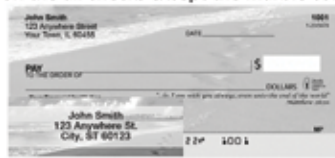

Scenic Scriptures ****No Matching Cover****



Mountain Scenery ****No Matching Cover****



Lighthouse Scenic



Horses



Big Horned Buck



Flowers



Beach Scenes

Check Order Instructions: Follow the numbers. Matching Address Labels: 144 Pcs - \$19.95 - 288 Pcs \$24.95 - 576 Pcs \$34.95 - 1152 Pcs \$54.95

- Check Design Name. _____
- Name, address, and info that you want printed at the top of the check.
- Your check will print exactly as you write it below. 5 Lines maximum.
// Your order will ship to this address unless noted otherwise //

- 100 - Single Checks - 1 Box - \$40.00 100 - Duplicate Checks - 1 Box - \$44.00
- 200 - Single Checks - 2 Boxes - \$58.00 200 - Duplicate Checks - 2 Boxes - \$61.00
- 400 - Single Checks - 4 Boxes - \$94.00 400 - Duplicate Checks - 4 Boxes - \$99.00

FREE SHIPPING - ALL ORDERS!! Each order includes 2 deposit tickets per book of 25.

You must include a blank check for the account you are ordering checks. Write "VOID" on it. If at all possible, please include a deposit ticket of the same account. Some banks require this!

- Starting Check # _____
- Contact Number: If at all possible please provide a Phone or voicemail # that we may contact you if there are questions regarding your order. This will not print on your checks.
PH# _____
- Payment: Payment in full is required to process your order.
 Check Enclosed ACH - Withdraw From Checking Account
- Qty | Description | Each | Total

Qty	Description	Each	Total
	Address Stamper	\$36.00	
	Personal Checks		
	144 Address Labels	\$19.95	
	288 Address Labels	\$24.95	
	576 Address Labels	\$34.95	
	1152 Address Labels	\$54.95	
	Black Vinyl Cover	\$7.50	
	Black Cover *Im Leather	\$24.95	
	Matching Cover *Im Leather	\$29.95	

LEAD TIME: Most orders ship out 5-8 business days after we receive your order. Allow for shipping with USPS.

Order by Mail or Phone. Payment required with order.
Make checks payable to Cornerstone Business Printing.

Ph # 574-642-3430
Fax # 574-642-4059
sales@cornerstone.info
Mailing Address
801 Wayne Street, Ste. 11
Middlebury, IN 46540

Signed _____ **Date** _____

If you live in any of the following states please add the correct Sales Tax. If your state is not listed, do not add Sales Tax.
Indiana 7% - Pennsylvania 6% - Ohio 7.75% - Michigan 6%
Illinois 10% - Kentucky 6%

** A "rounded" County Tax has already been added for Ohio & Illinois. **
Please call in your order if you want to be charged your actual County Rate.

Subtotal	
Sales Tax	
Total	

BENEFIT RAFFLE FOR

A.C.A.P. Amish Cummunity Aid Plan for Medical Expenses

Drawing will be held March 6, 2026 at Buster Miller Farms.
(Winner need not be present to win)

Please make checks payable to ACAP

16' x 24' Pavilion
or \$10,000 Cash Option



Pinecraft 16 x24 Timberframe Pavilion stained & installed with concrete floor.

\$2,000 Shopping Spree



13' x 13'
Springfree
Trampoline

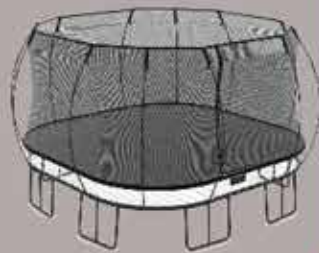

Aoxun
Aluminum
Patio Set



FOR TICKETS CALL OR SEND TO:

Joey Byler

17465 Peters Road
Middlefield, OH 44062
440-632-3117

Merlin Troyer

6622 US 322
Windsor, OH 44099
330-814-5489

TICKETS ARE
\$20 EACH OR
6 FOR \$100 OR
40 FOR \$500

_____	QUANTITY	_____
_____	Pavilion	Cash
_____	Shopping Spree	
_____	Trampoline	
_____	Patio Set	

PLEASE MAKE CHECKS
PAYABLE TO: ACAP



CALL IN YOUR CLASSIFIED ADS!

1-800-355-2192
(Mon - Fri 8-5 EST)

Deadline:
NOON
Friday

You may also fax 1-800-574-4204 or email classifieds@busybeaverpublicationsllc.com

Ads must be paid with credit/debit card (call us w/ info).
A \$3.00 convenience fee will be applied.
All ads must be pre-paid to run.

Name _____

Address _____

City _____

State _____ Zip _____

Phone# _____

FOR FREE, include my:

name address phone #
must choose at least one

Choosing more than 1 category?

Remember, you must pay the full ad price for EACH category you check. Example:
\$15.00 ad x 2 categories x 2 times = \$60.00

- | | |
|--|---|
| <input type="checkbox"/> Horses & Tack | <input type="checkbox"/> Household/Furniture |
| <input type="checkbox"/> Livestock | <input type="checkbox"/> Lawn & Garden |
| <input type="checkbox"/> Pets & Supplies | <input type="checkbox"/> Maple/Maple Supplies |
| <input type="checkbox"/> Poultry & Small Animals | <input type="checkbox"/> Miscellaneous |
| <input type="checkbox"/> Beekeeping | <input type="checkbox"/> Office Supplies/
Publications |
| <input type="checkbox"/> Bicycles/Scooters | <input type="checkbox"/> Produce/Edibles |
| <input type="checkbox"/> Building Supplies | <input type="checkbox"/> Produce Equip/ Supplies |
| <input type="checkbox"/> Business Opportunities | <input type="checkbox"/> Real Estate (For Rent) |
| <input type="checkbox"/> Carriages | <input type="checkbox"/> Real Estate (For Sale) |
| <input type="checkbox"/> Clothing/Dry Goods | <input type="checkbox"/> Rentals |
| <input type="checkbox"/> Construction Equip. | <input type="checkbox"/> Sawmill Equipment |
| <input type="checkbox"/> Crafts | <input type="checkbox"/> Services Rendered |
| <input type="checkbox"/> Electrical/Solar | <input type="checkbox"/> Shop/Tools |
| <input type="checkbox"/> Farm Related | <input type="checkbox"/> Special Events/Notices |
| <input type="checkbox"/> Garage Sales/Benefits | <input type="checkbox"/> Sporting Goods |
| <input type="checkbox"/> Greenhouse/Growing | <input type="checkbox"/> Transportation/Taxi |
| <input type="checkbox"/> Hay/Straw/Feed | <input type="checkbox"/> Wanted Items |
| <input type="checkbox"/> Health/Naturals | <input type="checkbox"/> Lost & Found/ Free Items
(No Charge, 1 time only) |
| <input type="checkbox"/> Help Wanted | |

Payments for classified ads in one or multiple issues are **NON-REFUNDABLE**.

New!
ADD AN EMOJI

Your ad just got more exciting!
Circle your emoji & draw a line to the spot you'd like it placed in your classified ad below. Easy!
Add \$1.50 per emoji when calculating your final cost.
Shown actual size.

dog tractor smiley megaphone deer star ball/bat horse scooter

SUBMIT A CLASSIFIED AD

Place one word only in each box below.

\$15.00 for first 12 words			
15.45	15.90	16.35	16.80
17.25	17.70	18.15	18.60
19.05	19.50	19.90	20.40
20.85	21.30	21.75	22.20
22.65	23.10	23.55	24.00
24.45	24.90	25.35	25.80
26.25	26.70	27.15	27.60

Mail this form
AND check payable to:
Busy Beaver of MI
61362 CR 43
Goshen, IN 46528

MAIL-IN classified questions:
CALL 574-501-5105

Next MI DEADLINES

Noon

Friday, Feb. 20

Friday, Feb. 27

Friday, Mar. 06

1	\$15.00 first 12 words 45¢ each additional word per each Ad Category Cost for ONE TIME	
2	EMOJI 🐶 how many? \$1.50 ea.	
3	SUBTOTAL ADD box 1 + box 2	
4	PENNSYLVANIA how many issues	
5	OHIO how many issues	
6	MICHIANA how many issues	
7	NEW YORK how many issues	
8	TUCKESSEE how many issues	
9	TOTAL Number of issues (add boxes 4-8)	
	TOTAL COST (Multiply box 3 x box 9)	

The Busy Beaver

Customer Appreciation

sponsored by Simply Lights

Giving away 30"
Kitchen Island Light
every week!

All customers placing a
classified ad in any of the
January editions are eligible.

Display Ads

IMPORTANT: We do not publish ads without a full ad order and print-ready PDF file (both must be received by deadline).

MULTIPLE TIME DISCOUNT GUIDELINES: In order to enjoy the multiple time rates listed here (12-25 time or 26-52 time rate), you must schedule specific edition dates and ad size must remain the same for the entire run. You may send new artwork for each time. If nothing new is received by the deadline, we will re-run from the previous edition.

DESIGN SERVICE? Yes, we can design an ad for you. Please contact us to have your ad designed. 574-501-5105.

WORKING WITH A DESIGNER? If a third party is sending your ad file, be sure he/she includes all required ad order information from the submission form. Or, you may contact us with the required info by calling the MI display ad team at 574-501-5105.

Pricing All prices shown are PER TIME			
Full Page	Discount	B&W	COLOR
7.4" w x 9.6" h			
1-11 times (or ads)		\$312.00	\$412.00
12-25 times (or ads)	5%	\$296.40	\$391.40
26-52 times (or ads)	10%	\$280.80	\$370.80
1/2 Page			
Horizontal 7.4" w x 4.7" h or Vertical 3.6" w x 9.6" h			
1-11 times (or ads)		\$200.00	\$257.00
12-25 times (or ads)	5%	\$190.00	\$244.15
26-52 times (or ads)	10%	\$180.00	\$231.30
1/4 Page Vert.			
3.6" w x 4.7" h			
1-11 times (or ads)		\$131.00	\$168.00
12-25 times (or ads)	5%	\$124.45	\$159.60
26-52 times (or ads)	10%	\$117.90	\$151.20
Business Card Horiz.			
3.5" w x 2" h			
1-11 times (or ads)		\$ 65.00	\$ 85.00
12-25 times (or ads)	5%	\$ 61.75	\$ 80.75
26-52 times (or ads)	10%	\$ 58.50	\$ 76.50

Classified Section Only Ads			
2 x 2 Display Ad 2.33" w x 2" h PREPAID			
1-11 times (or ads)		\$ 53.00	\$ 53.00
12-25 times (or ads)	5%	\$ 50.35	\$ 50.35
26-52 times (or ads)	10%	\$ 47.70	\$ 47.70
Business Card Vert. 2.3" w x 4" h			
1-11 times (or ads)		\$ 79.00	\$100.00
12-25 times (or ads)	5%	\$ 75.05	\$ 95.05
26-52 times (or ads)	10%	\$ 71.10	\$ 90.00
Banner Ad Horiz. 7.5" w x 1.5" h			
1-11 times (or ads)		\$121.00	\$152.00
12-25 times (or ads)	5%	\$114.95	\$144.40
26-52 times (or ads)	10%	\$108.90	\$136.80
Banner Ad Vert. 2.3" w x 8.25" h			
1-11 times (or ads)		\$139.00	\$175.00
12-25 times (or ads)	5%	\$132.05	\$166.25
26-52 times (or ads)	10%	\$125.10	\$157.50
1/4 Page Horiz. 4.8" w x 3.6" h			
1-11 times (or ads)		\$149.00	\$190.00
12-25 times (or ads)	5%	\$141.55	\$180.50
26-52 times (or ads)	10%	\$134.10	\$171.00
3/8 Page Vert. 4.8" w x 5.9" h			
1-11 times (or ads)		\$175.00	\$226.00
12-25 times (or ads)	5%	\$166.25	\$214.70
26-52 times (or ads)	10%	\$157.50	\$203.40

WE RESERVE THE RIGHT TO REFUSE ANY ADS WE DEEM INAPPROPRIATE. Busy Beaver of MI is not responsible for the outcome of products advertised within.

SUBMISSION FORM

Ad Size: _____

Print my ad in: B/W COLOR

How many times should we print your ad? _____

If more than 1 time, print my ad...

- consecutively every other issue once per month
 specific dates _____

How will we receive your ad? Mail Email

Do we have your ad already on file? Yes No

How will you pay? Payment is enclosed Send me an invoice
2x2 Display Ads must be prepaid

BILLING INFORMATION:

Business Name _____

Contact Name _____

Billing Address _____

Billing City/State/Zip _____

Phone _____

Mail:
 Return this form and a clear, ready-to-scan ad to
Busy Beaver of Michiana OR
 61362 CR 43
 Goshen, IN 46528
 574-501-5105

Email:
 Email required info from this form and a print-ready PDF ad file to
ads@busybeavermi.com

Have you moved? -or- Want to Subscribe?

and want your Busy Beaver of Michiana to arrive in your new mailbox?

Fill in your old and new address below.

Old Address (for change of address request only)

Name: _____

Address: _____

City: _____ State: _____ Zip: _____

New Address

Name: _____

Address: _____

City: _____ State: _____ Zip: _____



Mail completed form to:
 Busy Beaver of Michiana
 61362 CR 43
 Goshen, IN 46528

Please allow 3-4 weeks for your subscription to become active.



Sell your horse in the

\$80 First Region (5 Available Regions: PA, OH, MI, NY, TK)
\$60 Each Additional Region

Horse Corral

Deadline is
Thursdays at noon



330-201-9582

To trot your horse in the corral contact: horsecorral@busybeaverpublications.com

\$16,500



5 y/o Bay M. S: Kan Classic, SOD: Carry The Dream. 16.1hh. Well bred, sweet, buggy broke. TSS. HCP. In foal to Noble Venture 5.6.26. W/ PD breeding to Sting Like A BK. 319.646.1201

\$6,000 OBO



3 y/o Reg Percheron Gelding.
231.924.1204

\$8,000



Derwanda Buenos Aires.
3 y/o Reg Morgan Stallion.
Excellent pedigree. 330.231.5219

CALL FOR PRICE



6 y/o Imported Purebred Leopard Noriker Proven Stallion. Rides & drives.
330.231.5219

\$22,000 OBO



2 y/o Stallion, Explosive Matter, D: Rocky Road Reba (Guccio). Dam sold @Harrisburg \$47,000. S: A Masterpiece x Andover Hall. 260.977.8157

\$14,000



11 y/o Muscles Yankee x SJ's Caviar Stud. 16hh. Great conformation. Proven producer. 814.280.1121

\$14,500



6 y/o Muscle Mass x Kadabra Mare. 16.1hh. Big, Powerful Mare. Drives the best. The Ultimate Buggy Horse. Fresh. 814.280.1121

\$7,500 OBO



4 y/o Father Patrick x Break The Bank K x Conway Hall. Very sharp Mare. Good race family. Broodmare only. 814.699.1502

\$2,800



2 y/o Stdb Pony. 14.2hh. Well started in cart. Good-minded Filly. 330.440.8757



Sell your horse in the

\$80 First Region (5 Available Regions: PA, OH, MI, NY, TK)
\$60 Each Additional Region

Horse Corral

Deadline is
Thursdays at noon



330-201-9582

To trot your horse in the corral contact: horsecorral@busybeaverpublications.com



\$12,500 OBO

14 y/o Broodmare. Credit Winner x Malabar Man. In foal to Ohio Com Sir Slay. No Known breeding issues. 330.601.3272



\$17,500 OBO

11 y/o Broodmare. Credit Winner x Andover Hall. In foal to Ohio Com Sir Slay. Lots of potential. No known breeding issues. 330.601.3272



\$20,000

4 y/o Mare. Mets Hall x Credit Winner. 16.2hh. TSS. 100% broke. Absolutely UNREAL! 570.532.8548



\$12,000

4 y/o Mare. Cantab Hall x Muscles Yankee x Pine Chip. TSS. 100% broke. Very athletic. 570.532.8548



CALL FOR PRICE

Yearling Friesian Stbd Stud Colt. Auke by Mr Cantab. 330.600.2029

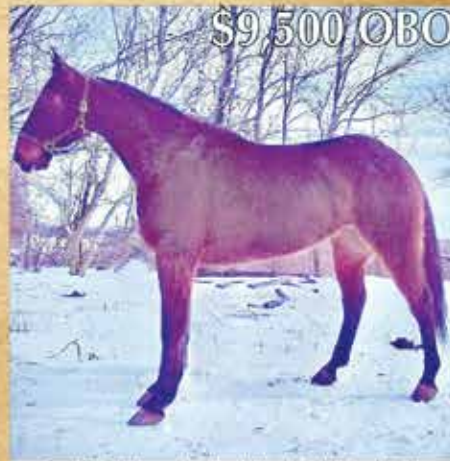

\$9,500 OBO

5 y/o Gelding. Looks Like A Chip'n'Dale, SOD: Cantab Hall. TSS. Been to town, church, out after dark. Trotted in 56. 606.336.8911



\$30,000

11 y/o Mare. S: My MVP, D: Master Lavac. In foal to Four White Socks. Due 05.02.26. 937.798.3172



\$12,000 OBO

DOB: 5.22.2019 Mare. D: Muscle Mass. TSS. Good driving horse! 717.529.1945 x1

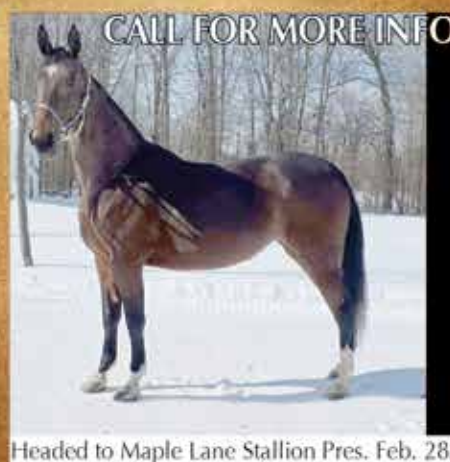

CALL FOR MORE INFO

Headed to Maple Lane Stallion Pres. Feb. 28. Selling as Lot# 202. In foal to Honorable Oz. 6 y/o Dream On Koz x Banker Hall x Pine Chip. 330.889.2125



Sell your horse in the

\$80 First Region (5 Available Regions: PA, OH, MI, NY, TK)
\$60 Each Additional Region

Horse Corral

Deadline is
Thursdays at noon



330-201-9582

To trot your horse in the corral contact: horsecorral@busybeaverpublications.com



\$10,700 \$14,500

7 y/o Gelding. Sire: Uppity Hanover, Dam: Shipps Speed. 16.1hh. Serious driving machine!! Dream Come True Type Horse! TSS. 330.231.0218



6 y/o Mare. International Moni x Andover Hall x Sierra Kosmos. 16hh. Fresh. Granddaughter of the Great Fern. HCP. 518.384.5329



\$9,500

8 y/o Mare. Muscle Mass x Incredible Abe. 16hh. Buggy broke. Drives good. TSS. In foal to Walner Son. Due in May. 518.384.5329



\$7,800

4 y/o Chapter 7 son x Awesome Victory x Super Bowl. Well broke. Drives good. TSS. 518.384.5329



\$8,500

1 y/o Filly. Dream On Koz x Muscle Massive son. Big, stretchy. Long neck, pretty head. All the tools to be a star. 518.384.5329



\$11,500

6 y/o Mare. Crazy Wow x Conway Hall. 16hh. Personal horse 1yr. Bombproof. Broke. TSS. In foal to Kelly's Flash for Apr. 518.384.5329



\$5,500

4 y/o Stdb Gelding. Well broke. Drives good. TSS. 315.952.2174



\$3,500

6 y/o Morgan Mare. 15.2hh. Very solid build. Old Style Morgan. Good broke. A lil' touchy around ears. Drives nice. TSS. 315.952.2174



\$3,500

4 y/o Saddlebred Gelding. 16hh. Sharp. Has some class & alot of fire. Well started. 315.952.2174



Sell your horse in the

\$80 First Region (5 Available Regions: PA, OH, MI, NY, TK)

\$60 Each Additional Region

Horse Corral

Deadline is
Thursdays at noon



330-201-9582

To trot your horse in the corral contact: horsecorral@busybeaverpublications.com

\$5,500



5 y/o Stdb Morgan Gelding. 16hh. Very solid. Buggy broke. Ready for miles. TSS. 814.954.2739

\$6,000



8 y/o Stdb Mare. Always A Virgin. 16.1hh. Fresh. First set of road shoes. Big, Solid Mare. TSS. 814.954.2739

\$3,800



2 y/o Reg Stdb x Dutch Mare. S: Big Z Crown Son. Well started in harness. Very sharp. TSS. 814.954.2739

\$5,200



8 y/o Stdb/Dutch Gelding. 16.1hh. Buggy broke. Drives very classy. TSS. 315.952.2174

\$15,000 OBO



2 y/o Stud Colt. A Masterpiece x Angus Hall. Good manners. HCP. 440.437.5438

\$5,500 OBO



8 y/o Morgan Stdb Gelding. JBM Strut N Tom. Boys horse. Ready for miles. 440.437.5438

Truckers EQUINE TRANSPORT

- Dan Nisley 330.473.2268 (Mt Hope/Holmes Co.)
Weekly Runs: Northern IN every Weds. & to Middlefield, OH every Thurs.
- Joe Miller 260.336.8422 (Northern IN)
Weekly Trips to IA, MO, IL & Direct Runs from IN to PA
- Loper Livestock. Nathan Loper. 740.258.3935
Coast to Coast
- Marvin Miller 330.275.5388 (Holmes County, OH)
Bi-Weekly to NY & MI
- Wes Bontrager 989.424.5182
Clare, MI to Northern IN

RARE OPPORTUNITY!

S: To Be Glory,
D: Mr. Cantab,
SD: Angus Hall.
5 y/o 16hh Stallion.
Headed to TLA Trotting
Classic Sale, Feb. 21.

\$2,250



2 y/o TTPA Reg Gelding. S: Don't Miss That Joke, SOD: Just Do It. Broke to drive. 989.386.3679

RHINO VOLTZ Authorized Distributors
Northern IN & Southern MI
M&W Repair
574.642.3556
All Other Areas
RhinoVoltz
717-492-7119

No Grid? No Problem.



Solar Controllers

Lithium Chargers

Inverters

DC to DC Chargers

Call for our new Catalog!



HORSES & TACK

1 Breeding contract for sale to Howe Stormy. \$1,000.00. Larry Hochstetler, 260-977-2422

1 KATIE'S JOE breeding for 2026. Taking bids deadline February 18th. 330-432-3565

1 Mare Monitor foal alarm, lightly used. \$2,000.00 OBO. 812-486-8848

1 Number for April Chupps Pony Auction. \$300.00. 574-903-7433

1 y/o filly. Mr. Hard Rock x Donata Hanover x Credit Winner. Sharp, refined filly with a lot of trot. \$11,700.00 OBO. 484-746-0638

1 y/o Gypsy Vanner Palamino Paint stallion. Registered, very pretty. \$6,500.00. Joe Troyer 9305 W 700 S Topeka, IN 46571, 260-894-4838

1.5 y/o Percheron Hackney, hite blaze, two white socks. 1 y/o Percheron Hackney, would go with first horse as team, well matched. \$1,000.00ea. 260-415-9173

10 y/o black Dutch STB mare, \$3,500.00 OBO. 3 y/o green-broke Dutch STB Morgan gelding, \$3,500.00 OBO. Leroy S. Miller, 989-386-6952

11 y/o Black Bay Mare, Sire: Dejarmbro, Dam: SJ's Photo, 2DD: Sierra Kosmos. 15.1hh, been our main horse last few mos, TSS, \$3,800.00. 574-584-4278

11 y/o registered Belgian stallion sired by Chief Supreme x Orndorff's Congolaise Supreme \$2000. 717-235-2509

Horse Corral



\$12,000 OBO

2 y/o Stallion Prospect, 52" .
Sire: Long Lane Snickers.
330.440.5886

HORSE CORRAL ADVERTISING FORM

1. Name: _____

2. Billing Address: _____

3. Ad Phone Number: _____

4. Photo! _____

5. Selling Price: _____

6. 12 Word Description: _____

7. What Regions? (Circle: PA, OH, MI, NY, TK) _____
\$80 =1st, \$60 = Add'l)

8. Send me an Invoice
 Call me for Credit Card

*** Publication Date is Two Weeks After Thursday Deadline.**

Contact: **330.201.9582**
for details
horsecorral@busybeaverpublications.com

Horse Corral
8065 Twp Rd 652
Millersburg, OH 44654

Display Ad Sales

Busy Beaver Publications

574-501-5105

Fax: 574-312-2775

ads@busybeavermi.com



All ads are appreciated!
Any Size. Any Color.
Classified ads? Refer to page 7.

11 y/o STB gelding. Very well broke, boys or family horse. Good traveler. Been everywhere. Women have driven him. TSS, \$3,600.00. Junior Weaver, 440-739-0662

11 yr. old Belgian mare, sire Diamond, in foal Never Done Fire's Chip, broke. 260-415-1419

11 yr. old mare, sire Lucky Chucky, dam Cantab Hall, in foal to Crazy Prince and comes with a breeding to Dream's A Sizzlin, broodmare only. \$8500. 57943 County Rd 33 Middlebury, IN 46540, 574-612-2297

11 yr. old reg. bay Standardbred mare, Amigo Hall x Andover Hall, in foal to Show Me A Million, broke for most women, TSS, in foal for 2026. \$8500 OBO. Goshen, IN. 260-350-7188

12 y/o bay ASB mare registration #151859. Gets sore on trips. \$2500. 607-875-0456

12 y/o STB gelding. Stands good to hitch, very calm at stop signs. Still a strong, clean-legged horse. Broke for anyone to drive. TSS, trots, \$3,100.00. Junior Weaver, 440-739-0662

12 y/o Native Yankee x Sierra Cosmos x Speedy Crown mare. 16H. In foal to Cue Hall for April. Also, paid breeding to Howe's Stormy. \$6,000.00. 717-475-3940

12 y/o registered Morgan Stallion 189502, TSS, very nice classic trot, nice horse to drive, most of his colts have a white star. \$10,000 OMO. Rockville, IN. 765-505-1963

12 yr. old bay mare, 16.1, sire Jailhouse Jesse, dam Self Possessed, in foal to Newtown Chocolate Tier son for March, fills both hands and drives like a 5 yr. old, asking \$7000. 563-543-5429

13 y/o black trottingbred race pony broodmare in foal to Chrome Flywheel, throws nice foals. Yearling Tymal Tullo bay filly out of above mare, has wow factor. 10 y/o brown and white 37in pony mare, my five y/o daughter drove last summer, in foal to black 38in stud. 2 y/o black and white stud, 42in, was good broke as yearling and settled 2 mares, fancy. Yearling gray/ blue roan filly, will mature around 44in, nice prospect. 574-238-8955

13 y/o reg Belgian stallion named Weaver's Hank sired by Thunderbranch Prince. Proven to produce quality foals. 3428 Old Philadelphia Pike Ronks, PA 17572, 717-768-0107

13 y/o registered Musclini x Pine Chip. Due in February 2026 to Dream Rocker. Sells with a free breeding to Rev-N-Roll. \$11,500.00 OBO. 330-600-8648

14 y/o black STB gelding, absolutely broke for anyone, women can drive, TSS, \$2,000.00 OBO. 440-635-6960

14 y/o black STBD gelding w/4 whites, stripe travel good we take US 20 to town, speed up from loud traffic from behind, nothing you can't handle. \$1200 OBO. 11970 W 050 N Middlebury, IN 46540, 574-825-5637

14 y/o full Dutch mare. 3 whites and a snip. Would make a daudy horse. Still good for long miles. Broke to ride and drive. No feet issues. In foal to Royalty For Life. Due in February. \$4,500.00. 260-278-1994 or 260-385-1782

PEP COACH RIDER NOW AVAILABLE AS A DUAL SEATER
Sleek, sturdy, and designed to ride smooth. Comfortably seats two, easy to handle, and built for everyday use.

Treat Yourself Or A Loved One This Holiday Season

MK Farm & Harness
"When Only The Best Will Do"

FINANCING AVAILABLE

CALL NOW! 231-928-6451

FREE BOWMAN BIT WITH PURCHASE

SHIPPED TO YOUR DOOR

WANTED

All types of horses and ponies.

Sound or not sound.

Also buying blind horses.

Top prices paid.

Middlefield, OH every Thursday.

Kidron - Mount Hope daily.

Bellville - Fredericktown weekly.

All other areas write or call:

J.S. Horse Farm
13914 Mount Eaton Road
Doylestown, OH 44230

Phone 330-715-0363

16 y/o Standardbred mare, goes good in buggy, selling as broodmare. \$2500. Amos Graber 3806 E 500 S Waldron, IN 46182, 260-568-0656

16 y/o Standardbred Morgan broodmare, open still good for short trips. \$1500 OBO. Also, her yearling stud out of Friesian Meranbo. \$1500. Daniel Yoder 2357 Fitzner Rd Greenville, MI 48838, 616-225-1499

16 yr old STB male American Winner x NV Worthy. In foal to Howe Stormy for May. HCP broodmare only \$6,500. 6 yr old reg. Friesian STB gelding. Blocky and black, women broke, TSS, good traveler. \$8,800. 814-290-9271

19 y/o bay STB stallion, He's Spooky. Sire Cantab Hall, SOD: Lindy Lane. Rec. 1:52, earnings \$410,000.00. Has produced a few sale highlights. Still extremely fertile. \$6,500.00 OBO. John Raber, 330-275-9301

19 y/o STB mare, Wewering x Corleone, TSS, broke for the women and school children, good broodmare, travels well, \$2,000.00. Joe Miller 5109 E Browns Rd Clare, MI 48617, 989-386-3679

2 coming yearling Belgian fillies 3/4 sisters, grade, pulling bred. \$2000 each. Mark Girod 315 S Van Buren St Monroe, IN 46772

2 Elects Buck Mares out of King Final Dam. Full sisters, 5 and 6 y/o. In foal. To be at Southern Indiana Draft Sale. March 6 at Dinky's.

2 y/o bay filly. Sire: Rollin The Cash. Dam: Angus Hall. 2D: Balanced Image. Broke and jogging. Hard copy papers. \$6,600.00 OBO. Josh Beechy, 574-202-9582

2 y/o Belgian gelding, not broke, dam is good worker. \$2100. Fritz Bontrager 8255 W 100 S Shipshewana, IN 46565, 260-336-5866

2 y/o Belgian Stallion, red sorrel, full stripe. Stallion prospect. Sire CD Rex, Dam Elects Buck. 4065 E 550 N Montgomery, IN 47558, 812-486-5439

2 y/o Filly, Guccio, Majestic Son Earl. Very pretty. Classy, 3wks driving. Maternal Sister was in Show Ring. \$15,000.00/OBO. 519-595-8501

2 y/o half DHH half STB Keystone Marlboro x Solist/ Armbaro Solar filly. Ready to train. \$4,000.00 OBO. 2170 W 700 S Topeka, IN 46571, 260-214-1767

2 y/o red mare. 1/2 standardbred 1/4 quarter horse & 1/4 racing pony, broke to ride & drive. 260-251-7369

2 y/o Jasper The Man x Soxboro Flame x Angus Hall filly. Nice big long neck. Started jogging. \$12,500.00. 3 y/o Harry's Out x Donerail mare. Well broke, fancy, lots of drive. \$12,000.00. Call for pictures. 717-475-3940

2 y/o Majestic Monarch/ Guccio; Stud, sharp, lots of headset, \$6800.00. 2 y/o A Masterpiece filly, star, snip, pretty head, but needs feed and time, \$9800.00. 717-344-8463

2 yearling dark bay fillies eligible to register 1-Sire Royalty For Life's son S.O.D. currant cast S.O.S.D. Pine Chip 2- Sire Pass to a Dream S.O.D. Donato Hanover S.O.S.D. Malabar Man \$4500 each or take both for \$8000. 715-267-1489

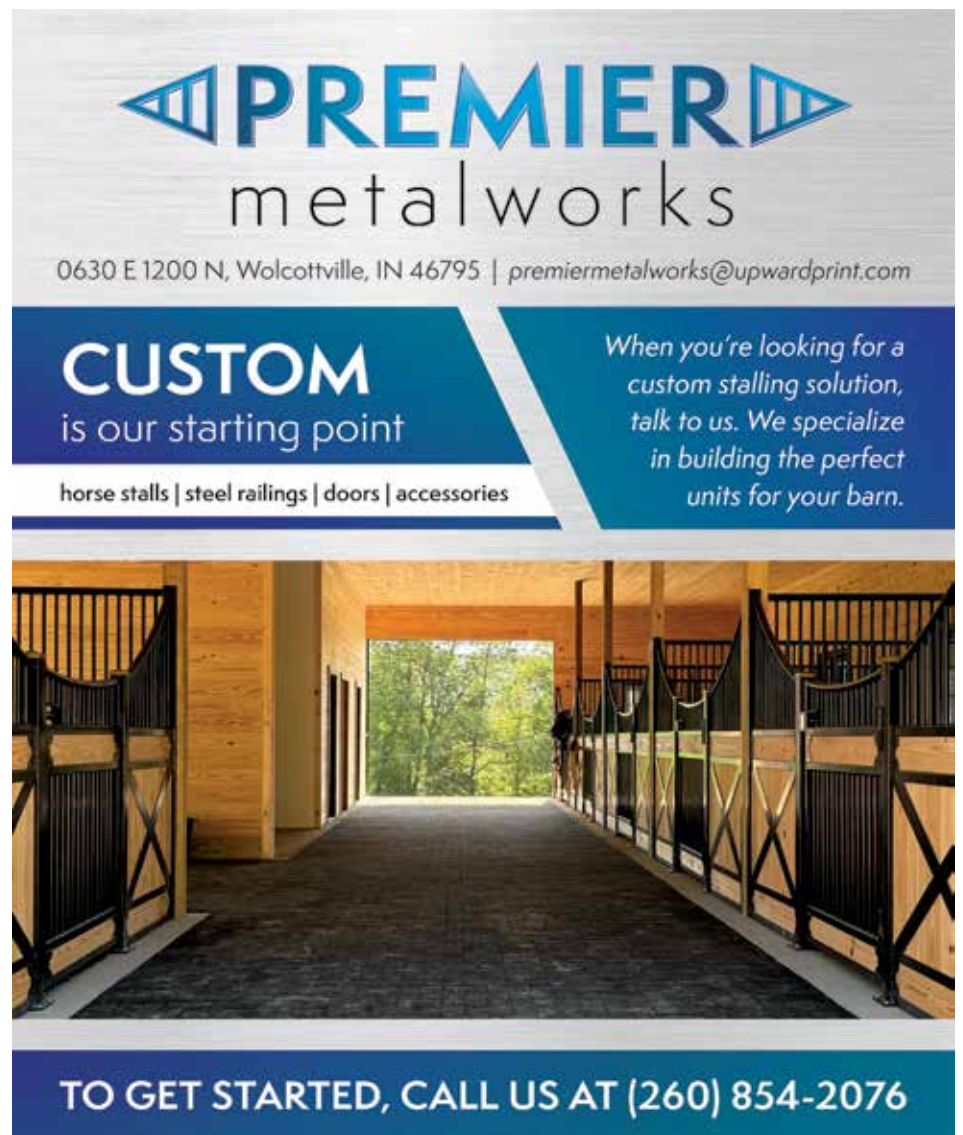

PREMIER
metalworks

0630 E 1200 N, Wolcottville, IN 46795 | premiermetalworks@upwardprint.com

CUSTOM
is our starting point

horse stalls | steel railings | doors | accessories

When you're looking for a custom stalling solution, talk to us. We specialize in building the perfect units for your barn.

TO GET STARTED, CALL US AT (260) 854-2076

2 y/o, 54" tall, black gelding with some whites. Starting in a cart. 1/2 Hackney, 1/2 Friesian. Lots of potential. \$4,000.00 OBO. 260-278-1994 or 260-385-1782

2 y/o mare, halter broke, needs training, papers coming. Sire: White Pine Blaze. \$1,700. Wayne County, IN. 765-541-0128

2 y/o Standardbreds well started. Sired by Majestic Monarch, A Masterpiece, Game Stop. Variety of quality and prices. 717-874-7325

2 y/o Stdb Mare by SD Rocketeer/ Malabar Man. Sharp, ready for training. \$15,000.00/OBO. 717-222-0153

2 y/o STB filly sire. Yankee Patrol. Dam by Creatine. \$4,500.00. 1 y/o stud. Sire: Lifetime. Dam: Creatine. \$2,400.00. Both have hard copy papers. 574-281-9436

2 y/o STBD Friesian black gelding, halter broke, nice headset, spring sale project. \$1800 OBO. Vic Graber 591 Clarendon Rd Quincy, MI 49082, 517-740-4086

2 yr. old Friesian/Standardbred Bay mare, ready to train. \$5500. Yearling Friesian/Standardbred, dark bay stud colt, Abby/Angus Hall, Kadabra. \$4100. Yearling Friesian/Shetland, black stud colt, sire Auke. \$3500. Yearling black & white stud colt. \$1500. Larry Eash 10070 N 400 W Ligonier, IN 46767, 260-585-7297

2 y/o stud Sire: Swan In A Million. Dam: Conway Hall. 2nd Dam: Lindy Lane. \$5500.00. 440-313-4586

2- 2yr old Registered Belgian mares Sire Triple M Farms MasterPiece Halter Broke \$4500.00 or both for \$8500.00. 270-823-8921

2026 breeding contract to WB Rampage, \$3,750.00. 260-215-6265

2026 Breeding for A-Master-piece \$4500. Or lifetime breeding share for \$21,000 OBO. 270-604-3214 or 270-466-5012

2026 Breeding to BKE West Master. LFG. \$5,700.00 OBO. 484-746-0638

2026 breeding to Oldtown's Mayor, \$1,500.00 OBO. 260-350-2883

2026 breeding to red hot Incredible Ozzy. Live foal guarantee. 519-722-2466

2026 breeding to Trumpstar Yankee with a 1 year return privilege. Book is full \$4800 OBO. 330-465-9391

2026 Breedings to SDRocketeer, make offer, Goldtime \$1950. CJ'S Champ \$550 OBO. 330-231-4898

2026 Cruisin With Chrome breeding for sale. 330-407-6259

2026 Flashback breeding for sale, \$1000. Also, Break Out The Gold contract, \$1500 OBO. Gordonville, PA. 717-327-3102

2026 Four Stars Robro contract. \$3,500.00 OBO. 260-214-5262

2026 service fee to Trumpstar Yankee for sale with 1 year return. 330-893-3251

3 y/o black and white paint, around 55", broke to ride, green broke to drive, call for more info, \$8,000.00. 260-585-7699

3 yr. old black Percheron stud by A&R Gambler. Also, a 2 yr. old Rossland Marcus grandson. 574-825-7074

SUNSET HORSE WALKER

Hydraulic and Electric Units Available

ONLY \$500.00 DOWN

KAYCEE'S
(330)390-6012
SALES@KAYCEESOH.COM

FINANCING AVAILABLE

3 y/o Friesian STB black mare. Sire: SB Rocky x Tomki x Spencer Hall dam. Rhonda x Mintse. Broke, still watches big trucks some, otherwise TSS. Drives with snug lines, archey neck & sharp, \$5800.00 OBO. 440-858-5944

3 y/o gelding, sire Olympic Son, women broke, TSS, \$6,200.00 OBO. 260-361-1871

3 y/o Indiana Swan/ Dundersteen gelding. Started to the buggy, will make good double buggy horse. \$4,500.00 OBO. 2170 W 700 S Topeka, IN 46571, 260-214-1767

3 y/o reg. 1/2 Friesian 1/2 STBD, black 16.1 HH, gelding, sire CJ'S Cody, dam Firman P x King Konch, broke, TSS, been to church and out after dark, sharp up headed gelding that can take the miles and looks good doing it. \$6800. Free delivery. Amos Wagler 10211 Williams County G Bryan, OH 43506

3yr Blue Roan quarter horse stud nice build, nice size \$4900 OBO. Aden Raber 19188 Township Rd 146 Kenton, OH 43326

3 y/o Reg. Belgian Mare, red sorrel w/stripes. Sire: BW Blings Mr Dillin (Relyb's Balance Son). Green Broke. \$3,000.00/OBO. Orva Hershberger 62243 Co Rd 37 Goshen, IN 46528, 574-642-4568

3 yr Morgan x Hackney pony. Vineyard Road Auction bound Sat. March 21st! A 56" buggy pony with lots of drive & stamina, fancy, a young boy's dream. For more info, write: Crist E Miller 227 A Logtown Road Fultonville, NY 12072

3 yr. old Crystal Springs Titan mare, broke, registered. \$10,000. 9 yr. old grade Belgian mare, hot. \$5000 OMO. Reuben Schmidt 2908 S 100 E Monroe, IN 46772, 260-223-0078

3 yr old bay Royal Trump /Buggy pony filly, 61" Very pretty and well filled out. Would make a great smaller horse for someone, is not broke because have never got to it. Very well mannered \$4750. 618-214-3618

3 yr. old STBD gelding, bay, good broke, TSS, travels good, ready for miles. \$3000. Gabe Miller 13896 Co Rd 22 Middlebury, IN 46540, 574-364-8773

3yr old registered geld. Incredible Ceremony XDejambro, well started \$4500. 4yr registered pacingbred mare mostly trot sells with a 2wk trial. 330-600-1242

4 y/o bay home raised mare, trottingbred, broke, needs miles, \$4,600.00 OBO. 260-336-6639

AGRESTORE'S DIAMOND'S
DREAM
DETWEILER'S PRINCE'S DIAMOND x AGRESTORE'S CARITA BY COWBOY CHIEF

FOLLOW YOUR DREAMS

PROVEN SIRE OF...

HITCH
Misty Spring's Dream Charlie
Carey's Dream A Little Dream

HALTER
Meadow Creek KOC
Meadow Creek Reed

SIRE
L.V.R. Cajun
M.Y. Diamond Dream's Rocky

THANK YOU TO ALL WHO BRED TO DREAM IN 2025. WE ANXIOUSLY AWAIT THE 2026 FOALING SEASON!

Misty Springs BELGIANS
PETER YODER & FAMILY
CO-OWNED WITH BRIAN HEURING & NEBERGALL BROS.

STANDING AT
435 S.R. 557 | MILLERSBURG, OH 44654
PH: (330) 231-2776

Yoder's Equine Body Work
Horse Treating
Magna Wave and Dentistry

Satisfaction is our goal.

Let our 2 yr. experience help your horse.

Also offering to rehab your horse for you.

To schedule an appointment
Call **Cindy Chapen**
810-441-1090

Samuel Yoder
2891 Harrington Rd.
Brown City, MI 48416

4 y/o 15.2H bay with 2 whites Morgan gelding (Rodeo- Ellies-Trebles) TSS, stands to hitch & at corners, sharp upheaded gelding. Ready for young dauddies or the ladies, \$8700.00. Mervin Bontrager 69730 Co Rd 7 Nappanee, IN 46550, 574-773-5455

4 y/o 58" stb/ pony gelding, blood bay, four whites, star, well broke, unreal in harness, super driver, sale prospect! \$4,500 OBO. 3 y/o 57" stb/ pony gelding, bay, 3 whites, good broke, drives up and on \$4,200 OBO. 4 y/o 57" stb/ pony gelding, bay, star, TSS, needs firm hand at corners, fast traveler \$3,500 OBO. Joe Bontrager 9100 W 400 S Topeka, IN 46571, 260-593-3111

4 yr. old gelding, home raised, nice and blocky, needs miles. \$4000 OBO. Daniel Shetler 4618 N 150 E Portland, IN 47371

4 y/o 59" black Morgan STB mare, broke to drive, nice blocky mare. Had very sharp filly last year, shies at big traffic, \$4,000.00 OBO. Kevin Miller, Ligonier, IN. 260-350-9989

4 y/o 41" black pony gelding with 1 y/o pony cruiser and older harness, this is a project for someone, currently not for small children. \$3500 for package. 9785 Tobacco Dr Clare, MI 48617, 989-339-7244

4 y/o 59in bay gelding. Sire Big Stick Lindy, Dam Morgan Hackney Buggy Pony. Boy's horse, good broke but has some smoke. Gets really hard on the bit. \$3,650.00. 3 y/o bay stud, full brother to above gelding, not broke. \$1,850.00. 574-642-4285

4 y/o and 7 y/o Belgian mares, red sorrels with strip. 7 y/o is very good broke. 4 y/o is broke. Both in foal. Due in June. \$3,000.00 each. Ernest Wengerd 4215 W 150 S LaGrange, IN 46761, 260-214-5949 x1

4 y/o bay 59in buggy pony mare, 3 whites and a star. Sire Kenmar Smokey Bear, Dam Pony. Boy's horse deluxe, fancy. \$4,750.00 OBO. 574-825-4614 x5

4 y/o bay buggy pony gelding, good broke, stands to hitch and at corners, speeds up from loud traffic, wife drove him, \$3,500.00. 21 y/o black race pony mare, in foal to STB, \$900.00. 3 in one package, \$4,000.00. 260-593-0346

4 y/o black Percheron stud. Old style. Stocky built. Can work anywhere. 16.3H. 80" around chest. A proven breeder. Very easy going. \$6,500.00 OBO. Jacob Eicher Jr. 6760 Austin Rd. Camden, MI 49232

LaRue Livestock Auction

Draft & Driving Horse Sale

Saturday Feb 28th , 9:00 AM

60 Belgian Teams

- 300 head of Draft and driving horses
- 1 day Sale
- 60 teams ,mostly pullingbred & right off the farm
- Great selection of Standardbreds & Crossbreds
- The draft horse Quality is high
- Don't miss this sale
- Call Lavern **231-246-0290** for free catalogue or more info

Blondy's Doc S74953

Sire: Sharp Turns Farm Blondy By Elect's Buck

Dam: by MDL Roscoe Farceuer

6 yr. old Stallion , Weighs #2600 , has 7-8 Siblings that are pulling Proven Breeder, Cherry Red w/ white Mane & tail ,Big & powerful

Sale Location :1059 Richwood Larue Rd, LaRue OH 43332

Halter Foaling Monitor

- Runs on 2 AAA Batteries per unit.
- No Electric or 12Volt Needed.
- Up to 1 Mile Range.

Pocket Pager

Mare Transmitter



BUNKER HILL APPLIANCE

4575 Township Road 365, Millersburg, OH 44654

330-893-3700

Hrs: Mon-Fri 7am-5pm, Sat 8am-11:30am



Keystone Sales

332 Hollow Road
Quarryville, PA 17566
717-715-3498



Retail Price
\$410.00

DURA DRINKER

- Extremely durable construction.
- Virtually maintenance free.
- No gas or electric wires to cause potential shock.
- Can be used for all size animals.
- Will not rot or rust.
- User friendly design allows for easy cleaning and service of the drinker.

4 y/o bay registered 15H STB gelding, Sire Poppin' Yankee, Dam American Winner. Very good broke. Ready for the miles. \$5,250.00 OBO. 574-825-4614 x5

4 y/o Belgian mare. PVF Rick J, SOD: Orndorff's Master Encore. Broke to all farm machinery. Bred to Oak Trees Mauric. \$7,000.00 OBO. 260-888-6681

4 y/o black 1/2 STB, 1/2 Dutch. Has 3 whites on her feet. Ready for long miles. TSS. No feet issues. \$5,750.00. 260-278-1994 or 260-385-1782

4 y/o Dutch STB cross gelding, 16.1HH, bay with two whites, green broke, has been hitched to buggy, TSS, stands to hitch, \$3,500.00. Nappanee area, 574-285-4422

4 y/o reg. mare. Muscle Massive/ Andover Hall. SOSD: Valley Victory. Hard copy papers, boys horse deluxe! Drives like her pedigree. Never been bred. \$22,000.00 OBO. Emery Troyer 2614 Farren Hill Rd Moore, MT 59464, 406-380-1451

4 yr. old Mr. Cantab/Crazed/ Royal Troubador, in foal to Dover Dony, modern and refined. \$9000 OBO. 260-593-2011 x4

4 y/o Standardbred trotting mare. Sire Ozzie's Son. Dam: Grade. 15.2H, well broke, extremely fancy, ready for miles, drives up and on. \$4,500.00. 5550 Curtis Middlefield Rd West Farmington, OH 44491, 216-645-3196

4y/o Standardbred mare. Bay, star, 1white. Sire: He's Gorgeous. SOD: Cruiser Weight. Decent traveler. Buggy broke. \$4500. 574-392-1202

RUSSIAN ORLOV TROTTERS
for Sale

- Stud colt born 5/5/25, homozygous black, two white hinds; sire: Zhasmin
- Filly born 4/25/25, bay w/ small strip, tall & refined; sire: Beluzhnik
- Filly born 8/3/25, black, two white hinds, small & pretty; sire: Beluzhnik

Buy into the breed that produces superior road horses

Farbig Farm
61788 CR 35 Goshen, IN 46528
(574) 825-3943

Signature
- CARTS
BY P.E.P.

Roadster



FINANCING AVAILABLE



NEWLY DESIGNED



- ADJUSTABLE STIRRUPS
- ADJUSTABLE SLIDE SEAT

CUSTOM SEAT TRIM



Now Available In Pony Size.



Distributed By



KAYCEE'S
(330)390-6012
SALES@KAYCEESOH.COM

DEALER INQUIRIES WELCOME

4 y/o registered STB mare, Chrome Master x Speedy Bones x Dream Vacation. Sharp, up headed and has that Chrome Master drive. Broodmare, Surrey horse, or both; you decide! \$9,500.00. 44429 Township Rd 314 Coshocton, OH 43812. 740-824-4771

4 y/o Standardbred gelding buggy broke, well broke, sound and 100% bomb proof on traffic. Round and fat, easy keeper, well mannered, pretty well anyone can drive. Ready to go anywhere, will travel however you want him to travel. \$4,500.00. Depending on location reasonable delivery. Justin Plank 7307 W Kinsel Vermontville, MI 49096, 517-726-0706

4 y/o Standardbred bay mare. Sire: Barnes and Bars. Dam: Sing Jesse Sing. TSS, well-mannered horse in the barn, \$9,000.00 OBO. 269-257-1504

4yr Old Reg. Grey Mare 18HH Well Broke Calm \$7800. Free Delivery Abraham Swartz. 16978 Horseshoe Bend Rd Newcomerstown, OH 43832

5 y/o black mare. 54" 1/4 Friesian, in foal to Homozygous black/white. Broke, \$5,900.00 OBO. 4 y/o 46" black/white mare. Broke to ride and drive, \$4,900.00 OBO. 937-464-2536 or 937-464-2595

5 y/o Friesian STB mare. Family broke, TSS, \$4,300.00. 765-635-7991

5 y/o black 60in buggy pony mare, broke but not quite sound, in foal to Muscle Murray for April baby, throws nice foals, \$2,500.00 OBO. 5 y/o black buggy pony mare, broke but needs work, wide awake, in foal to Big Stick Windy son, \$3,500.00 OBO. 6 y/o Friesian STB cross gelding, broke for most women but will look at some things, not fast, \$4,500.00 OBO. 2 y/o grey Dutch saddlebred mare, registered, not broke but small, \$1,000.00 OBO. 4 y/o Skyway Caleb pony cross mare, 60in, bay, strip, two whites, in foal to Master for June baby, not 100% sound, nice mare, \$6,000.00 broke. Older bay buggy pony mare, in foal to Master, \$1,500.00 OBO, broodmare only. 12 y/o 36in pony mare, chocolate, broke but not a babysitter, full of fire, bred to black and white 36in stud for June baby, \$1,700.00. 5 y/o mini Jenny donkey, in foal, \$1,800.00, gray in color, also more donkeys available. 574-642-0240

5 y/o dark bay trottingbred gelding, 16.1HH, sire Winky's Pine, dam Muscle Massive, broke, he won't disappoint, HCP, \$11,000.00 OBO. 260-336-6639

5 y/o mare, Guccio x Hard Rock-n-Roll. Broke. Sells with paid breeding to Lordy Lordy. \$13,500.00. 740-447-4645

5 y/o Standardbred Gelding 15.3H trotter, dark bay. Easy going horse with good road speed, family safe, TSS, \$4,700.00. 517-270-8303

5 yr. old Standardbred mare, sire Theirgoesmygroom, by Muscle Mass, dam Nikes Image, in foal to Dover Dony, TSS, broke for the women. \$7700 OBO. Lavern Hershberger 4374 W 1100 N Ligonier, IN 46767, 260-350-2283

5 y/o strawberry roan Mustang mare. Green broke to ride. \$1,500.00 OBO. 937-205-4262

WB RAMPAGE

A Masterpiece x Revenue S | S0SD: Pine Chip
Reg# 7ZE38 | DOB 04/05/2023

LIMITED LIFETIME SHARES AVAILABLE!

Standing At Pleasant Ridge Equine
574.825.0218
Trained and Presented by Slate Acres Stables LLC
Photos and Design by Summit20.net

Pleasant Ridge EQUINE
Slate Acres Stables

5 y/o Swan For You x pony mare. 61" very sharp bay w/3 whites and star. A long stretchy mare that travels 10-11mph and drives tops. Looks at traffic but nothing bad. If they like them on the bit, the ladies can drive her. \$5,000.00, two week guarantee. Horsin' Around Equine, Rochester, IN. 574-223-5729

5y/o Trotting mare : Harry Walker/ Amigo Hall- Broke, ready for miles. TSS. \$6000. Usually have a several on hand. 260-223-1722

6 y/o Morgan/pony gelding, fast traveler, young boy's dream, sale project. \$3600 OBO. Also, 38D Weststar cruiser, almost brand new, used twice, new around \$2200. \$1900 OBO. 260-241-5101 x3



5 yr. old Buggy Pony Mare
Good Broke
Ready for 10 miles
TSS
\$2,500 OBO
440.346.7387

6 y/o 18hh Reg. Belgian Mare. Blonde w/Stripe. Sire: HS Captain Ducati, Dam: Prairie Creek Master Mac daughter. In foal to Relyb's Balance Son. Broke but not kids horse. \$4,500.00. Orva Hershberger 62243 Co Rd 37 Goshen, IN 46528, 574-642-4568

6 y/o big black Caballero/ Morgan mare, not sound, in foal to Classical Ace, call for more info. \$5,000.00 OBO. 260-585-7699

6 year old Standardbred Dutch gelding, 17 hands. Personal horse for one year. Fancy and ready for miles. 6 year old Morgan Standardbred Dutch cross gelding, home-raised, good broke, family or boys horse. Fun to drive, nice horse. Stephen S Stoltzfus 2311 Bear Run Rd Taneytown, MD 21787, 717-661-7947

6 y/o black STBD Friesian gelding, 16.5 HH, sire Marten Meintsje, SOD Victory's Force SOSD Balanced Image, broke for the buggy, still sees some odd things, but nothing you can't handle, nice big horse, very pretty drive, asking \$5000, must sell. Vic Graber 591 Clarendon Rd Quincy, MI 49082, 517-740-4086

5 yr. old Percheron gelding, black star long tail, well broke. \$3200. Adam Miller 15160 6 Mile Rd Morley, MI 49336

6 y/o Belgian mare, broke to all farm machinery, works all day in the field, has too much spunk for me. \$4000 OBO. Needs to go don't get used enough. Also, older Belgian mare, still in good shape, broke. \$1000. Vic Graber 591 Clarendon Rd Quincy, MI 49082, 517-740-4086

6&7 y/o 3/4 Stdb 1/4 Percheron, 6y/o travels good but hot, 7y/o broke good. Both field broke. Big Solid Surrey Mares! \$3,000.00/EA/OBO. 11851 Co Rd 20 Middlebury, IN 46540, 574-825-3705

5 yr. old Standardbred cross mare. \$3500 OMO. Eli Miller 7212 Kendaville Rd Lakeview, MI 48850, 989-352-1229

7 y/o Belgian Gelding broke to all farm machinery and produce equipment, \$4,500.00. 989-424-5267

REMEDY for SCRATCHERS Guaranteed!



HERE TODAY, almost GONE TOMORROW.
 "A no pain, Low odor, Scratchers Remedy"
 VET Formulated,
 Conditional Money back Guarantee!!

\$49.95 + SHIPPING!
 Order Now!
 "This purchase treats approx. 2 horses"

Elite Equine Products LLC
 Call Elmer At: 260-238-5002
 Elmer Graber, 18903 Bull Rapids Rd,
 Spencerville, IN 46788

*Considering taking Mable to the sale at Gordyville?
 Does she always look tired like she's going uphill?
 Notice as soon as she steps off the trailer
 Her muscles so tired she sways like a sailor
 By the time the auctioneer starts his chant
 Mable's wore out and starts to pant
 Now what to do when all bids fall
 And you take her back home from the sale
 Now it's time to give Mable some life
 This time you better listen to the wife
 So what that product she talked about
 Dad, try Lions 6-Way the children shout!
 Lions 6 - Way top dress – 1–2 # per day*

**Lions 6-Way is available at your local feed store
 through Cisco or for mail order call FD Miller Feed
 217-543-2346 EXT 5 • 8-9 AM CT**

7 y/o Belgian mare, sire Captain Class's Ruger, SOD NVF Flash, great confirmation. **9 y/o Belgian mare** grade a Snappy team. \$6000 each. 989-872-5708

7 y/o Standardbred mare 15.1H, very well broke, mostly paced, stands to hitch and at stop signs, no papers. \$1,700.00. 5550 Curtis Middlefield Rd West Farmington, OH 44491, 216-645-3196

7 yr. old, registered gelding, Dutch STBD, watches large loud traffic, runs with a hike, was my main driver for 3 yrs. \$4500. Danita Martin, 574-374-6454

7y/o 16.3hh Black Saddlebred gelding. HCP TSS Speed up from loud truck from behind, sees dark spots on road. Been to Walmart, Aldis, stops at stop signs and lights. Been my main horse the last 3 years. Travels 11-12mph. Mans horse. Toby Hochstetler, 260-593-0413

8 y/o STB gelding. 16hh, good thinking horse. Ready for trips. TSS, trots. \$4,400.00. Junior Weaver, 440-739-0662

8 y/o black Winand x Sand Vic mare, 16.3, this mare will fill both hands & travels fast. In foal to Keystone Marlboro for April baby. Gary R Yoder, 574-349-4483

8 y/o registered Chestnut Morgan mare with a strip and 2 whites. He is broke for the ladies, good traveler. In foal for a mid-May baby. \$5,500.00. Jerry Bontrager 6683 W 200 S Topeka, IN 46571, 260-214-4974

8 y/o STB mare, sire Armbro American, in foal to Indiana Swan, due in April. Surrey mare, good broke, no papers. Not quite sound but takes lots of miles, \$5,000.00 OBO. Joe D Miller 7000 W 400 S Topeka, IN 46571, 260-593-0955 x1

8 y/o registered Belgian mare. Sired by L Valley Double Power Ball. SOD: Harbor Haven Extreme. Due in April to Whispering Winds Cactus. \$8,000.00. **3 y/o Belgian Gelding** \$4,500.00. 717-874-7325

8 y/o standardbred gelding, good trot, head up, stands to hitch & at corners, sticky starter nothing bad. 5 to 7 mile trips is perfect. \$4,000. Call for more info. Wayne County, IN. 765-541-0128

8 yr. old, registered Standardbred mare, TSS, average traveler, can handle a lot of miles. \$3700 OBO. 260-463-3778

9y/o Mare.Sire: Holiday Road. Dam: Pine Chip. In foal to Don't Let'em for 2026. \$10,000.00. 260-350-5058

Ramers Ranch

Looking for a horse or buggy pony? I always try to keep some in stock. All horses sell with a 2 week trial.

Josiah & Kathleen Ramer
67071 CR 7, Wakarusa IN 46573
574-862-1284

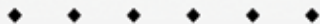

4 yr. Black 58" stdb x pony gelding. If you need one that like the miles and loves to run check him out. \$4500



4 yr. Black 60" Buggy pony mare. Lots of class and fun to drive. \$6000



6 yr. Bay 60" stdb x pony mare. Stands to hitch and at corners. 100% TSS. \$7500



Don't see what you are looking for? Give us a call our inventory is always changing we may be able to help you find what you're looking for! Satisfied customer is our goal!

Crazy PRINCE
CRAZED-ROSEMOUNT PRINCESS X SIERRA KOSMOS
RN124 STANDARDBRED STALLION 5/1/2015

TO BE PRESENTED AT
Mid-Michigan Horse Sale
AT EDMORE, MI FEBRUARY 21ST 2026
DISCOUNT AVAILABLE DAY OF PRESENTATION

5 BREEDING SHARES
AVAILABLE IN 2026

PREPPED & PRESENTED BY:
MARC MILLER
574-825-9307

STANDING AT:
 EVERGREEN STABLES

OWNED BY:
K&W STABLES
WILBUR MILLER
574-535-4228
KEITH MILLER
231-878-9827

9 y/o 56" bay buggy pony mare needs more work than we give her. \$2000. 9785 Tobacco Dr Clare, MI 48617, 989-339-7244

9 y/o ITPA Race Pony mare in foal to What's Up Dusty. Foal will be ITPA eligible. Broke. \$4,100.00. 574-312-9457

9 y/o Standardbred Gelding 16.1H, bay with 3 white ankles. Stands to hitch and at corners, safe for anyone to drive, TSS. 517-270-8303

9 y/o black pony mare 59" in foal to US Marshal, a Muscle Massive son due in March. TSS, can get on the bit. Fancy! \$6,000.00. 9 y/o Pinetucky mare. 16H, 4 white and strip. Whiskie dam, TSS, doesn't interfere. Needs firm hand at corners. Has staying power. \$3,500.00. 260-466-2358

9 yr old registered Gypsy Vanner broodmare in foal to the son of Misty Valley GV04421 for June 2026. \$17,500 OBO. 724-851-1323

9 yr. old Friesian Standardbred mare with paid breeding to (Crazy Prince) Standardbred stud. \$3500 OBO. 260-535-0955

9y/o mare. Sire: Swan for ALL. SOSD: Valley Victory. Boy horse or broodmare. In foal to Winning American \$12,500. 574-536-0843

Bay buggy pony mare, 7 y/o, TSS, stands to hitch but little uneasy at corners. \$3200. Kevin Beechy 4310 W 200 N LaGrange, IN 46761, 260-336-2885

Belgian/Halflinger crosses 2&3 yr. olds, green broke, call for more info, also yearlings. 260-282-1444

Coming 3 y/o STBD Friesian gelding, very well started, still needs little help to hitch up, forges some gets better every time we shoe him, 15.5 HH too many horses to mess with hm. \$2750 OBO. Vic Graber 591 Clarendon Rd Quincy, MI 49082, 517-740-4086

Chupps pony April sale number for sale, lot #31, \$500.00 OBO. Ethan Miller 11240 W 600 S Millersburg, IN 46543, 574-971-1297

Coming 2 yr. old stud, 1/2 Belgian 1/4 pony, 1/4 Standardbred, 1/4 pullingbred. Stephen Schmucker 994 State Line Road Montgomery, IN 49255

Coming 3 y/o Standardbred Gelding. Sire: Mr. Cantab. SOD: Majestic Son. 16H, TSS, \$5,000.00 OBO. 716-753-6093 or 716-485-3357

Coming 4 y/o bay Race Pony mare, good broke, would make a good cruiser pony. \$2,800.00. 574-312-9457

Coming 4 y/o black Deacon Valley STB gelding. TSS, good traveler, will be a woman's horse, big enough for surrey buggy. \$5,500.00. 269-316-0919

Coming 6Y/O E.T.R. Belgian stallion, sire Sunset Acres Prince Dam, Bar-B Anna red sorrel LMT, Stripe Broke to work, clean horse. Proven sire \$4500.00. Johnny Raber 1452 Adario West Rd Greenwich, OH 44837

Count Diamond Stallion, proven producer of Show Horses. The Sire to Flicka's Count. Top selling gelding in Memorial Sale 2025. \$60,000.00/OBO. 519-595-8501

Cue Hall breeding for 2026. \$1,100.00. 717-348-7337

Quality Feed Carts

MADE TO STAND THE TEST OF TIME

- ◆ Held Shut with Magnets
- ◆ Keeps Your Feed Dry & Fresh
- ◆ Protected from Mice & Other Animals



**DEALER
INQUIRIES
WELCOME**

Available Sizes

200 lb & 300 lb

**NO DEALER IN YOUR AREA?
NO PROBLEM, WE SHIP DIRECT.**

AVAILABLE AT:

F.D. Miller Feed - Arthur, IL - 217-543-2346

Hawkeye Harness - Bloomfield, IA - 641-929-3188

EMAIL OR CALL FOR DEALER INQUIRIES & PRICING

Phone: 217-512-4925 | Email: hee@upwardmail.com

Consignments wanted any harness & tack shop related items for the 57th Annual Harness Makers get-together on June 17th & 18th at Mid-River Sales, call now for free advertisements. Mid-River Sales 10348 Co Rd 18 Middlebury, IN 46540, 574-825-9253 x1

Conveyor belt mats for horse stalls. Will outlast any mats you can buy. 1.50 to 3.50 a square foot. CK Beltco 7724 Banks Rd Gainesville, NY 14066, 585-567-2358

Discount Breedings: 2026 Breeding to Sweet Chariot \$600. 2026 Breeding to Rockin Stonsie \$900. Emanuel Yoder, 419-571-2372

Doughty Valley oat crimper, adjustable rollers to crimp multiple different grains, including corn, used but is still in working condition, electric motor. \$1000. 1790 3b Rd Bremen, IN 46506, 574-546-0376

Equine Leg Armor Special! Money back guarantee on arthritis, OCD's, fractures. Also help on suspensions. \$10 discount on 5/gallon bucket if paid in 10 days. Free shipping! Sunny Ridge Equine, 717-725-7541

Farm team Belgian geldings 3&5 y/o, good broke also 4 y/o Captain Encore mare, in foal, axle broke. Ernest Schwartz 9521 S 500 E Geneva, IN 46740, 260-849-2519

For Sale 10 y/o mare. Angus Hall Glide Master. In foal to A Domino Afect. \$26,000. 9 y/o mare. Andover Hall Windsong Legacy, \$18,000. 4 y/o mare. Whatthehill Dejambro. Fresh, \$16,000. All are TSS. 440-313-7610

For sale 4 yr. old STBD trotter, TSS, travels good, has a scar in the back leg, he got in the fence as a weanling, but 100% sound, personal horse for 2 years, has tapers. \$4000 OBO. Samuel Girod, 567-279-2244

For Sale 5 y/o Friesian/Standardbred cross gelding. Broke & can take a lot of miles, ready to go. \$4,500 OBO. Levi Wengerd, 260-525-0453

For Sale: 2026 Breeding for Accurate Citation. 330-473-7764

For sale: 2026 commercial breedings to Slay & Branded By Lindy. For more information, call 330-749-0144

For Sale! 2 Kan-Oz Breeding fees for 2026 breeding season. 260-466-6151

For Sale! Yearling Dondersteen filly, Dam Reach for Glory. Racing pony, very sharp. \$4,000.00 OBO. 260-466-6151

BUCKEYE ROLLERMILLS, LLC

SAVE UP TO 50% ON YOUR FEED BILL



NEW & IMPROVED

WITH ELECTRIC OR HONDA MOTOR!

3868 TR 629
MILLERSBURG, OH 44654
330-359-0340 VM

Mister Mischief
Winning Mister - Conway Hall



FountainNook Stables
Standing at: Fountain Nook Stables | 330-231-4548
Owned by: Jacob Stoltzfus | 814-349-5975
Fitted by: Robert Miller

For sale! 1.5 y/o Friesian STB stud, Sire Tomke's Turbo, Dam Credit Winner, dark bay. \$2,500.00. 1.5 y/o Morgan STB, Sire KJM Soul Commander grandson, Dam STB. \$2,000.00. Registered 7 y/o purebred Friesian stud, black, Sire Tomke, Dam Tekisha back to Norbert, proven breeder, throws nice long stretched foals. Oldest offsprings are 4 y/o. Good conformation, well broke. \$30,000.00 OBO. Reason for selling, going to Hackneys. Albert Mast 9866 Hardins Creek Rd Leesburg, OH 45135, 937-509-7040

For Sale! A Masterpiece Breeding Fee for 2026 breeding season. 260-466-6151

For Sale! Breeding stocks work great to ultrasounds and breed mares. 260-466-6151

For Sale! Yearling Brain Turner filly, Dam (Plian Liberator?). Sharp filly, black, 3 whites. 260-466-6151

For Sale! Yearling Dondersteen colt, Dam Money Talks. Dark bay, 3 whites, sharp colt. 260-466-6151

Hey, are your horses staying dry? If not. I have what you need. New 10x12 black & white, lined, horse shelter, \$1,950.00. Christopher Miller, 574-338-2818

Innovative treadmill for sale, \$4500. Needs one bearing replaced, otherwise good condition. Elmer Zook, 717-201-1039

I will be taking more Horses to Train this Summer! Call for Availability/Rates! Jeremiah Bontrager 18700 Fawn River Rd White Pigeon, MI 49099, 574-584-4278

Lady Clarabella, 2 1.54.2 \$175,057. Here is a big, long stretchy Lear Jetta mare! Her dam is Jet By which is by none other than Andover Hall! From 3 foals of racing age, she is the dam of Chapter Twelve, 1.53 \$140,000 and is by What The Hill, Lady Help Now, and racing... She had 2 What the Hills and both were very nice, correct individuals with lots of drive, averaging \$17,500.00 at the Ohio Select Sale! She is currently in foal to What The Hill for a March 1 foal. \$4,000 stud fee paid. This is a mare with tremendous upside in the driving/show world, or continue to breed commercial. The foal she is carrying now is a full sibling to Chapter Twelve 1.53 \$140,000 so great value at Select Sale or Roadster Market! Call 260-410-7346

Lifetime breeding share to the exciting, What the Hill. \$9000. 5425 W 200 S Topeka, IN 46571, 260-593-2011 x4

Like new Fine Harness. Black with red trim, \$750.00 OBO. 330-600-8648

MEMORIAL TROTTING SALE NUMBERS. Taking phone bids with deadline 2/21/26. 302-554-4227

Morgan broodmare deluxe, Triple Pine Liberty, sire Chip N Dale, dam Ultra Special Agent, \$7,500.00 OBO. 574-354-3214

Morgan filly 9 m/o, sharp black, Mizrahi grandsire. Out of good driving mare By CVMS Beauty's Revenge. Make offer. Lancaster, PA. 717-327-9639

Morgan Stallion 12yr. old Buck Shot, reg. #185902, big strong Morgan Stallion. \$10,000. 765-505-1963

NEW TO MICHIGAN

Mr Cantab x SJs Photo
Service Fee: \$800 Reg-\$500 Grade Live
Cover Only

Looking to raise big, powerful buggy horses?
Check out this impressive 16.1 HH powerhouse!

PRINCE

Cantab



Sign up at the Mid-Michigan Stallion Presentation and receive \$100 off.

SUNRISE ACRES EQUINE
Michigan Dealer

Vernon Hershberger | 5706 Shabbona Rd, Decker MI 48426
(989) 872 - 5059 (Call between 7:00 - 7:30 P.M.)
Owned by Cleason Heatwole, Grant Zimmerman & Herschy Acres

Morgans and Morgan crosses for sale. From yearlings to Broodmares. Some in foal. Some are broke. Some are ready to get started. Call for all information. 740-398-2458

Natural Horse Wormer. Easy to use & very affordable. Works very good. Order however many doses you need, \$8.50 each. Shipping available. Also available at: Carlisle Hershberger CR 50 Nappanee, Cornerstone Equine 650 W Nappanee, Josiah Schwartz Apple Rd Bourbon. Myron Hershberger 3425 Beech Rd Bremen, IN 46506, 574-209-6534

Nice 8 yr. old Dejambro by Jailhouse Jesse mare. \$6500 OBO. Call Paul, 765-509-8220

PHONE CORRECTED: 11 y/o Black Broodmare, ABC Garland X Photo Maker. 16.2hh. Still drives. In foal to Rev-N-Roll, due in April. Also sells w/Royalty for Life breeding. No breeding or foaling problems. \$14,800.00/OBO. 937-464-2614

Standardbred bio harness with pads. \$250. Also bio 50-inch pony harness with pads \$150. Both are like new! 269-858-9097

Sting Like A BK Breeding, \$1,750.00 OBO. 574-336-0303

Stori quick hitch jog cart with Fintac harness, cart is in very good condition and has been used very little. \$1450. 1790 3b Rd Bremen, IN 46506, 574-546-0376

Temporal Hanover breeding, \$7500.00. 10% down, balance at live foal. 260-361-1527

The last Alligator colt, has great action, dam Nobleman of Tudor Oaks. Exceptional Will Magic filly, dam New Treasure. Gypsy Crossbred GHRA mare, they all drive single, double and ride. 2025 Accolade of Genesis, granddaughter with Warbucks Bob dam. 2025 3/4 Gypsy colt. 260-273-3182



Two 2 yr old friesian standardbred mares, sired by the Ignighter, half-sisters, both have very good Dams, 1 has Super Bowl Donerail Dam, well-matched, ready to train, will be registered, make offer--trucking available. 315-867-6808

Tymal Tullo service fee for 2026 season \$2000. 260-221-4151

Wanted: Black/white pony fillies and mares. Yearling-5y/o. Registered or unregistered. 260-205-3500

What The Hill 2026 Breeding For Sale \$3500.00 OBO. 440-635-6075

Yearling Friesian Standardbred filly. \$3000 OBO. 260-535-0955

SERVICES

- Reproduction
- Mare Boarding and Foaling
- Yearling and Weanling Sale Prep

From conception to the sale ring, we're here to help you with your mare and foal, every step of the way.



JOEL & DORIS MILLER
(260) 977-8076
10325 W 200 S Shipshewana, Indiana 46565

Poole Forge



STABLES

Equine Transportation
Available From
PA to OH to IN
Every Two Weeks

Tim Martin - 717-419-1029
Kristi Martin - 717-468-3369

Call 717-989-2026 For
NY & DE Options

ivan@pooleforgeables.com

Yearling filly. Sire: Dondersteen. SOSD: Credit Winner. Call after 4pm. Harvey Weaver 7305 NY-474 Panama, NY 14767, 716-782-4606

Yearling STBD/pony dark bay mare, 2 whites, sire STBD, dam 50" pony. \$1500. Adrian Eash 10070 N 400 W Ligonier, IN 46767, 260-585-7297

Yearling, black Dream on Koz by Banker Hall stud colt. Snip, two whites, one of a kind. \$7,500. 717-371-2493

LIVESTOCK

Jersey Heifer, to freshen in February, \$2,500.00. 260-223-6239, work phone

55 Dorset - Dorset cross Ewes approx. half had lambs in Jan. rest are due in May. Will sell with or w/o lambs around 40 lambs \$22,500 OMO. William Hershberger 7739 Township Rd 95 Fredericktown, OH 43019

A2/A2 Jersey Family Milk Cow 3yrs old Currently dry but bred back and due in July. Johnes and BVD negative. Excellent manners and disposition. \$3500 firm. 989-429-0744

Calves for sale. 300-600lbs. 260-804-2305

Flock reduction, 140 Dorset Ewes, mostly Kuhns & Raber genetic. They will start lambing in the middle of April. We are planning to start milking cows or they would not all be for sale at this time. Jeremiah Kanagy 2649 Shreve Eastern Rd Shreve, OH 44676, 330-275-9510

For sale, A1A2 family style Jersey cow. Due 2/25/26 for 3rd lactation. Bred to A2A2 Jersey bull. \$3,000.00 OBO. Call for more information: 989-802-2703. Emery Stutzman 8531 E Beaverton Rd Clare, MI 48617

Heritage Pro Animal Minerals! A free choice mineral mix proven to suppress parasites, foot rot, boils, conception and birthing problems and more! We can ship. Pond View Soil Products 956 Vintage Rd Christiana, PA 17509, 717-201-9944

I castrate and implant calves, call for more information. 517-462-8886

Livestock Concentrate 100% Natural. Aids in animals digestive system for horses, cows, veal calves, goats, sheep, hogs. Faster weight gain, good bone structure, fights against hostile viruses and bacteria. Good for scours. 1pt\$19.00 SH\$8.00, 1qt\$30.50 SH\$8.50, 1gal\$88.00 SH\$12.00. OH residents add 6.75% sales tax. Schlabach Supplies, 8908 Barrs Mills Rd. NW, Sugarcreek, OH 44681. 330-897-0150

One yr. old Guernsey heifer, dam was A2A2, was also a good family cow. \$1850 OBO. 74 Schaller Rd Transfer, PA 16154, 989-802-1606

PASTURE PIGS, FEEDER PIGS, SHOW PIGS. BUY-SELL-CONNECT. 7LIVESTOCK.COM. Gilts, Boars, Sows, Barrows, Durocs, Berkshires, Mangalica, Idaho Pasture Pigs, KuneKune, Hampshire, Hereford, English Black, etc. Single Listing \$15.00. Litter Listing \$45.00. Map/Pictures/Detailed Descriptions. All 50 States/Canada. 330-550-3487

Wanted: Certified organic cows or Springers. They can be A1A2. 330-275-9510

PETS & SUPPLIES

2 Jack-Russel mixed females, born 11-27-25, make offer. Call for more info, 260-350-3677

2-1/2 Year old Proven Mini Poodle Males 1 Blue Merle 1 Choc. Merle. 11LB (No Papers) \$1000 ea. 330-275-6941

13 w/o AKC registered chocolate merle toy Poodle male, should mature around 8-10lb, \$1,500.00 OBO. Three AKC Apricot toy Poodle females, AKC registered, One has litter of 5 red and white poodle puppies, \$1,500.00 OBO. One is bred to blue merle Cavalier male, \$1,500.00 OBO. One just weened puppies, \$650.00 OBO. ALSO Silver 10lb CKC reg poodle male, \$500.00. Two Shihpu females, one is grey, bred to silver male, \$1,200.00 OBO. One is gray merle, not bred, \$1,000.00. Or, will make package deal. 574-642-0240



2 dark red Mini Poodle females. 2 Standard Goldendoodle females. One dark red, one parti. Both great mothers. Also one dark red Mini proven male. 2 females just started their heat cycles. 260-310-7978

3 y/o AKC short haired black and tan with white Mini Dachshund male, \$500.00 OBO. Topeka, IN. 260-593-0195 x2

4 year old Merle Poodle Male! Approximately 18 lbs! Throws very nice pups! \$700 OBO. Pittsford, MI. 517-438-0292! Leave message! 517-429-0234

5 y/o Portuguese Water Dog male. Brown and white. 330-473-3102

8 puppies for sale 5 w/o, unknown mixed breed, black and brown, gray and white and some black, \$50.00/ea. 60869 County Rd 35 Goshen, IN 46528, 260-499-0830

8x20 older mini barn set up for large-medium dogs. \$800.00 OMO. 260-336-1164

AKC 3 y/o red and white English Bulldog male, proven sire, 3 panel health clear. \$1,250.00 OBO. Nappanee, IN. 574-658-4571

AKC Breeding stock for sale. 2 Shihtzu males, 6 Cavalier males. Most colors available. Some genetic clear. Ages vary. Norman Schmucker 4935 N 190 E Howe, IN 46746, 260-350-2035

AKC Toy Poodle males, tri color, breeding age, health tested clear. Also, dark red Mini Poodles available. Good quality breeding stock. Ivan, 330-763-4614

AKC Golden Retriever sellout (due to moving), 4 females, one male, good mothers. Medium red, ages range from 3-5 y/o, \$1,000.00 for package deal. 5190 S 200 W Wolcottville, IN 46795, 260-463-1969

AKC Miniature red Poodle male, DOB 9-15-25, parents are genetic clear, up to date on shots, \$1,500.00 OBO. 606-308-9650

AKC red poodle males, DOB 5-16-24 and 5-6-24, both are proven breeders. Enos Lengacher, 260-573-1058

AKC registered proven Miniature Pinscher male, 1.5 y/o, UTD on shots, sharp, natural upright ears. Graybill, IN. Call 260-498-0551

AKC registered 10lb chocolate Poodle male, service fee \$500.00. 4.5lb blue merle poodle male, AKC and CKC registered, \$400.00 service fee. Red AKC 4lb poodle male with white chest, \$400.00 service fee. Blue merle cavalier male, \$400.00. Brindle AKC shih tzu male, throws nice pups, \$500.00 service fee. 574-642-0240

Aluminum dog kennel. Front, dividers, waters, feeder, & doggie doors. Lots misc. equipment. \$8,750. 574-914-1079

'ATTENTION' Waterfowl or Shed hunting dogs!! AKC Black lab puppies. DOB: 11-20-25. Both parents are trained for Waterfowl. UTD on all shots and deworming. \$600. 574-354-4199

BUYING PUPPIES, PAYING CASH. 18 years in business, if no answer leave a detailed message about your litter and I will call you back if interested. 317-260-0469

Cavalier females 9 mo. 1 Blenheim 1 Ruby. \$300 each. Kevin Beechy 4310 W 200 N LaGrange, IN 46761, 260-336-2885

Chow-Chow sellout due to moving, 5 females and 2 males, ACA and ICA registered, 2-6 y/o. Good demand for these puppies. Package deal \$5,000.00 OBO. 5190 S 200 W Wolcottville, IN 46795, 260-463-1969

Frenchies for Sale: 2 y/o New shade Isabella male. Small and compact, proven breeder, breeds natural. \$1,500.00. 2 y/o blue/tan female, just had 2nd litter, \$1,000.00. 2 y/o blue/tan female, bred to above male for 2nd litter, \$1,500.00. 7 m/o Isabella/tan female, nice. \$1,000.00. 7 m/o blue pied female, very nice, small and compact. \$1,500.00. 6 m/o blue merle female, nice and compact, \$1,000.00. Loren Miller, 260-593-3355

Good Health from the Inside Out

From puppies to seniors, dogs need balanced nutrition every day. **Essential Dog** supports digestion, nutrient absorption, and overall wellness at every life stage.



Just like humans, a healthy dog is content and happy. **Happy Dog** is a liquid probiotic / prebiotic blend to boost immunity and gut health. Puppies love the taste for weaning!



With cold weather challenging your dogs water consumption, keep them hydrated with **K9 Punch**, an electrolyte



powder blend to balance body fluids for speed and stamina. Can be mixed in feed.



All Natural Canine Supplements
800-990-9926

For Sale 10 M/O Yellow Lab Pups
1-male 1- Female ACA Registered
\$500. 5- M/O Black Lab Male \$500.
David Borntreger, 330-231-8988

For Sale: 1 yr old ACA Blue Merle
Boston Terrier male \$300. 4 yr old
ACA tri color Cavalier female \$350.
1 1/2 yr old tri color Cavalier male
\$200. 4 yr old ACA Red Merle
Pembroke Welsh Corgi female
\$350. 9 month old ACA Red Merle
Pembroke Welsh Corgi female
\$300. 3 yr old AKC Cocker Spaniel
female Brown white \$250. 3 yr old
Chocolate ACA Cocker Spaniel
female \$400 OBO. Louis Wagler
10211 Williams County G Bryan, OH
43506

 **GDM**  **Pet Supplies** dog
clippers, vaccines, wormer, dog
feed, underground fences, pet
carriers, dog kennels, new/ used
whelping dens. Free catalog. GDM
Dens LLC 4491 NY-14A Dundee,
NY 14837, 607-243-9718

Got Puppies? Accepting full
& mixed breed Adults! Get
the price you deserve for your
dogs! 419-551-7492

Jack Russells, born 1/15/26 ready
to go 2/26/26, mom is great family
dog with friendly personality, but is
pure death on rodent and varmint
control, wormed and shots up to
date. \$250 each. Joe Miller 9765
M571 Edmore, MI 48829

Mini Vidas test strips in stock,
including shipping. \$250.00. Contact
Thomas, 717-639-8607

Pet Supplies, Vaccine, Dewormer,
Record Keeping, Shampoos, Flea
and Tick control. Call for a FREE
catalog. New Bedford Feed and
Supply 33906 OH-643 Baltic, OH
43804, 330-897-6492

ShihTzu Male Age 2, tri-
color-\$300. Bichon Female Age
4-\$100. 574-642-4534

PetSafe 900yrd wireless training
collars 50%OFF. Regular \$179.95,
Sale \$89.98. GDM Dens LLC
4491 St Rt 14A Dundee, NY
14837, 607-243-9718

Puppy heaters propane/
natural gas. New and used units
available. GDM Dens LLC 895
Centerville Rd New Holland, PA
17557, 607-243-9718

Puppy Plus 100% Natural.
Supports immune gut, better heat
cycle, increased reproductive and
fertility, more puppies per litter,
chubby healthy puppies. Stronger
bones, weaning less stressful,
supports diarrhea, benefits kennel
cough, odor reduction. 1pt-\$19.00
SH-\$8.00, 1qt-\$30.50 SH-\$8.50,
1gal-\$88.00 SH-\$12.00. OH
residents add 6.75% sales tax.
Schlabach Supplies, 8908 Barrs
Mills Rd. NW, Sugarcreek, OH
44681. 330-897-0150

Tiny Chihuahuas chocolate male
female DOB 1/7/26 parents 5-6 lb.
wormed, vaccinated. \$750 each
OBO. 660-956-3255

Two 7 w/o Dachshund puppies,
male and female, mom is red dad
is English Cream that was imported
last fall, very nice, \$2,000.00ea. 9 y/o
Apricot Maltiepool female, matures
at 7lb, \$1,000.00. 574-238-8955

Used aluminum 10 run kennel
setup, with feeders, doggy
doors, for more info call. John
Lengacher, 260-417-6609

Wanted- Looking for "breeding"
age female German Shepherd.
Call with details. Amos Schmucker
11524 Doty Rd New Haven, IN
46774, 260-705-4172

We buy and sell litters of
puppies. 260-804-2305

**POULTRY &
SMALL ANIMALS**

2 pairs 2 y/o Temnick Tragopans
Pheasants. One 1 y/o male.
\$500.00/pair \$250.00/male
+shipping. 330-407-6338

Good laying brown hens \$6.
Grinder mixer MF \$3200. IH 510 drill
\$950. 3920 Baptist Rd Taneytown,
MD 21787, 315-403-3080

Poultry Booster 100% Natural.
Happy hearty healthy chickens,
increase egg production with
deep yellow egg yolks, eggshell
development, greater percent
hatchings, more energy during
stress. Broilers faster weight gain,
stronger bones. Chicks: head start
less loss. 1pt \$19.00 SH \$8.00, 1qt
\$30.50 SH \$8.50, 1gal \$88.00 SH
\$12.00. OH residents add 6.75%
sales tax. Schlabach Supplies, 8908
Barrs Mills Rd. NW, Sugarcreek, OH
44681. 330-897-0150

Taking orders for Isa Brown layers
your Up North source. Vern Troyer
3158 W Nicholson Hill Rd Ossineke,
MI 49766, 989-278-6777

**BE AN
EAGER
BEAVER!**

**BUY & SELL HERE
ANYTHING FROM A TO Z**

**NEXT
DEADLINE:**

**Friday,
February 20th @ NOON!**



BEEKEEPING

Bee supplies. Volume pricing.
Deep boxes \$9.95, mediums \$8.95, frames .90; assembled \$1.25.
 Waxed deep foundation \$1.50, mediums \$1.20. 300-\$400 shipping.
 Samuel L Fisher, Homestead Beehives 141 Eco Ln Aaronsburg, PA 16820, 814-349-5157

BUILDING SUPPLIES

Custom Vinyl windows, white or black available, welded frames and sashes interested in becoming a dealer. Call or write Das Fenster Haus 8764 S Broadway Rd Hastings, MI 49058, 269-223-0903

40 sheets used black metal 24ft long \$450. Used insulated white garage doors 7x9 \$350. 10x14 \$750. 260-440-6611

For sale! 18 White Vinyl House Windows, still in plastic. Call for pricing and sizes. 260-431-6744

New 60" Shower stall with corner seat. Small clear coat blemish on back wall. \$375.00. 717-381-9512

Silvercraft Barn doors, split for 12x12 opening and a split for 8x8 opening. All 4 have windows, color Taupe with burnish slate trim. 1 y/o. New condition. Call 260-223-2657

BUSINESS OPPORTUNITIES

HANDBAGS, TOTES, POUCHES, WALLETS and much more!
 We are looking for Nina LaVon consultants in your area! Wonderful growing business opportunity for stay at home mothers! No computers needed. Call Kathy Byler, 330-974-3805. 4100 County Line Turnpike Rd Southington, OH 44470

Midwestern company looking to expand in the East. Looking for individuals that like associating with people. 330-203-3792

CARRIAGES

2014 single buggy, slide back doors, frameless front, new steel wheels in 2018, LED lights, \$3,800.00 OBO. Sam Borntreger 799 N Lumberjack Rd Sumner, MI 48889, 989-285-5103

Hummer pony buggy in great condition. \$2500 OBO. 260-849-2116

Single buggy in good condition, brakes and lights work good. \$1000 OBO. 260-593-2011 x4

FLOORING SALE

	Per Sq/Ft
<i>3/4" Thick Solid Hardwood Unfinished T&G:</i>	
5" Red Oak Super Rustic (shorts) Full Skids only	\$0.95
2-1/4" (choice) Red or White Oak Cabin Grade (nice quality)	\$1.00
2-1/4" Red Oak #2 Common (shorts) (Like Cabin Grade)	\$1.08
4"/ 5" Red Oak #2 Common (character)	\$1.15
2-1/4" Red Oak #2 Common (nice quality)	\$1.60
3-1/4" Red or White Oak \$1.10----5" White Oak (Cabin Grade)	\$1.15
2-1/4" #2 Common White Oak	\$1.50
3-1/4" #2 Common White Oak	\$1.60
2-1/4" Cabin Grade Maple	\$1.35
2-1/4" Red Oak #1 Common	\$2.65
3-1/4" Red Oak Select & Better	\$2.99

Prefinished T&G:

5-1/8" New Heart Natural Pine	\$2.10
2-1/4" Natural Solid Hickory - First Quality	\$2.50
3-1/4" Natural Solid Hickory - First Quality	\$2.99
4" Natural Solid Red Oak - Cabin Grade (long lengths) (also have 5" @ \$2.99)	\$2.75
5" Provincial Hickory Hand Sculpted - Cabin Grade (nice brown color)	\$2.99
Happy Feet Vinyl Loose Lay Flooring 22mil wear layer	\$3.35

Easy to install with **no adhesive** or locking system, 100% waterproof, and very durable. Great for basements, concrete, or subfloors. Buy 1,440 sq. ft. or more and save 14¢ per sq. ft. on your entire order.

Other:

1x10 Standard Grade Ship Lap Eastern White Pine	\$0.90 ln/ft
1x10 Industrial Grade Ship Lap Eastern White Pine	\$0.57 ln/ft
1x4x16 White Pine Furring Strips/Trim Boards (premium)	\$5.50
5/8" 4x8 Deco Grade T1-11 8" O.C.	\$28.00
1.5" 4x8 EPS Foil Back Insulation (1/2" up to 3" in-stock)	\$16.00

Now stocking Lumber, #1 SYP and Spruce #2&btr -check out our low prices!

Shipping Available!

Truckloads Available!



12149 Gower Road * Glenford, OH 43739
Phone: (740) 659-1480
Fax: (740) 659-1481

Call us today for more pricing information and to explore our wide range of flooring options!

7th Annual Plain Beekeeping Meeting

In the Sprunger Building in Kidron, OH
 March 21, 2026

Topics include:

- Beginners
- Honey Production
- Queen Rearing
- Equipment Auction & more

Registration & lunch by donation

Please register with....

Plain Beekeeping Meeting

195 Messener Rd. Wooster, OH 44691

Taking Equipment Donations for Auction after the Meeting.

Topics will be in Deutsch

NEW Vendors on Site

Completely rebuilt surreys and Queens in stock, just like new, call for price and availability. Nisley Buggy Shop 62413 IN-13 Goshen, IN 46528, 574-642-0026

Double Seated Wood Pony Buggy, w/lights, canvas, upholstery, fits 45-58" Pony. \$900.00/OBO. 260-417-1990

For sale Fehr gear single buggy low miles, spring torsion rubber mounts, brakes included. \$3500 OBO. 989-756-2120

For Sale: Steel wheeled chop buggy with canvas to close in the back (in great condition). Trash pump (in working condition) Call: 260-450-4234

Nappanee style single top buggy, in good condition, will send pictures if interested. \$5500 OBO. Call or text, 260-404-1350

Top buggy, good shape, \$10,000.00 OBO. 260-415-9173

CLOTHING/DRY GOODS

★ **Cricut expression machine** with lots of accessories, lots of cartridges to go along. \$300. Can ship, includes Mickey Mouse font. 9785 Tobacco Dr Clare, MI 48617, 989-935-0176

CONSTRUCTION EQUIP

2019 Newholland C237 skidloader, 1800 hrs, track machine, Joy stick controls, heat/AC, 2 speed, comes with smooth bucket. Also 2010 Newholland LS170, 2500 hrs, enclosed cab, comes with bucket, runs and operates great. Call 717-875-8570

2021 Bobcat excavator E-85, long arm, dozer blade, stored inside, 1392 hrs. \$74,500. 260-615-8782

6x10 enclosed utility trailer, has a few dents. \$1000. 9785 Tobacco Dr Clare, MI 48617, 989-339-7244

Equipter Roofer's Buggy for sale. We currently have a great selection of used units. We offer some great financing options, some as low as \$560 per month. Call for details. Roof Assist Equipter Rentals, 717-278-6232



Flat River Farms
Fenwick MI

Tiling, Brush Mulching, Dirt Work,
Ditch Cleaning and Land Clearing

MARK STOVER
717-648-9883

REMINDER: BE AWARE OF SCAMS

Be aware of whom you are buying and/or selling to. Beware of scammers offering to sell your merchandise online for a commission Fee. If you are unsure ask for references and/or a website for verification..
Busy Beaver Publications
PO Box 3
Charm, OH 44617



\$55,000

2023 JCB 270T, 540 hr's, 2 speed, backup camera, reversing fan, smoothride boom, high flow, good condition Call 574 321 0409

Rubber tracks, steel tracks, undercarriage parts to fit your equipment. Excavators, skidloaders, crawlers, dozers, engine parts, hydraulic parts, final drives, etc. On-site service. Hydra Power Parts, 717-517-0387

For sale! JCB Skytrack 2005, foam filled tires, 6,800hrs. Also has pallet forks. \$25,000.00 OBO. 270-524-1676

ELECTRICAL/SOLAR

Battery Sale. Dewalt 20V 8AH DCB208, \$110.00. Dewalt 20V 5AH DCB205, \$58.00. Milwaukee M18 5AH 48111850, \$60.00. Makita 5AH BL1850, \$90.00. Makita 4AH BL1840, \$60.00. 6+ free shipping. Alan, 260-216-1072

LIFETIME WARRANTY BATTERY. Cold & Cloud Tough. Quit paying \$\$\$ yearly. 20+ yrs. Tens of thousands sold. For phone shacks, charging batteries, home/cabin/shops, solar & emergency. Call 877-782-7707

FARM RELATED

12ft box stall front with slider door and swing out feed door, no feeder. \$300.00. 574-312-9457

1956 John Deere 70 diesel with pony motor, 3pt hitch and wide front straight metal, nice paint, good running condition. \$9,000.00. 574-642-3824

Brush Hog skidsteer attachment 72" wide, new, never used, can deliver, \$2,600.00. 517-270-8303



FUEL YOUR CROPS NATURALLY!

- ✓ Organic Pelletized Chicken Litter
- ✓ Gently Dried
- ✓ Rich in Micro-Organisms
- ✓ 40lb Bags, Totes, & Bulk

GREEN FIELD Farms

GROW MAGIC
Unique Organic Fertilizer
4-3-2

Call for a quote today.
330.263.0246

6464 Fredericksburg Rd., Wooster OH 44691

6,00 watt line shaft generator BDN series. 120 or 240 volt, \$300.00. 12 assorted milker buckets, stainless steel claw washer and claw sink. LL 90 Pulsarators, make offer. Ernest Wengerd 4215 W 150 S LaGrange, IN 46761, 260-214-5949 x1

712 Whitehorse plow with Oliver bottom. \$1500. 1-bottom John Deere plow, mechanical lift. \$300. 250 gal. field sprayer on air. \$250. New idea rake/tedder. \$500. Alvin Lambright 7735 S 075 W Wolcottville, IN 46795, 260-854-2504

Farm Equipment sellout: 16 hole JD drill on rubber tires, excellent condition, always parked inside, \$1,500.00. Powerline equipment field sprayer with boom, like new, operates with gas motor, \$2,200.00. JD 2 row corn planter, excellent condition, \$1,500.00. 9ft Pequea tedder, good condition, \$1,500.00. JD Roller bar hay rake, good condition \$2,250.00. One bottom White Horse plow, \$2,500.00. Will sell package deals. 574-642-1180

Flat belts for thrash machines - silo fillers - round baler belts - also have belting that is good for ground cover/walk areas - weather stripping & more. CK Beltco 7724 Banks Rd Gainesville, NY 14066, 585-567-2358

For Sale: Mod 1816 Case skidloader with 34" bucket and new 22 HP Honda U-Twin engine. Ideal for cleaning out boxstalls. 260-705-4172

Hay wagons- New, treated beds. Flotation gears painted. 260-593-0055

JD 7000 planter, 4 row 30", monitor, martin-till row cleaners, seed firmers, no fertilizer. \$4000. 574-892-5166

Heston 540 round baler. Twine tie, makes 4x5 bales. \$4,000.00. Bryant PTO corn sheller, works great! \$750.00. 269-432-9648

Kubota BX-2230 sub compact tractor. 4WD, 3-point with quick attach, new battery & headlights, has a Brush Hog, disc, front blade, 1-bottom plow, lawn roller, & trailer. Good condition, \$9,950.00 OMO. 30591 Coohon Rd Colon, MI 49040, 269-689-6818

New and Used JD Tractor Parts. Seats, air ride suspension seats, mufflers, radiators, water pumps, hydraulic pumps, sheet metal, fenders, etc. Parting out John Deere New generation tractors. We ship UPS. Also, doing repairs on your tractor. Martin Repair, Goshen, IN. Call: 574-862-3910

New Holland 209 Discbine 2022 model like new condition. \$26,500.00. I&J Sickle 9ft bar trail behind mower with Honda motor and extra sickle, like new. \$7,500.00. New Holland 311 small square baler, very good condition. \$7,500.00. 574-642-3824

NI hay rake works, good paint. \$1800 OBO. DA plow, right hand single. \$1000. Feed bunks, used for calves. \$30 each. 13332 Co Rd 38 Goshen, IN 46528, 574-642-2692

Turn your woods into a farming opportunity with Gensing! Giving contracts! 629-266-0934

Sale on S&L cultivators, 4% if ordered by 3-1-26, 7% if paid by 3-1-26. Mtn Top Farm Shop 4794 Long Run Rd Loganton, PA 17747, 570-725-2228

Vermeer 554XL round baler. \$12,000.00 OBO. Massey Ferguson 165 diesel tractor \$4,000.00 OBO. 260-997-1424. Call after 5pm

WANTED: 2 wheeled powercart, diesel 45hp range, prefer stablizer type. 330-893-1999

Wanted: 4 wheeled power cart in good condition, 100 hp or more. 4485 E Milestrip Road Canastota, NY 13032, 315-684-3714

GARAGE SALES/ BENEFITS

SAVE THE DATE! 850 W Garage Sales! April 14th 7am-? Lots of homes participating! Teresa Gingerich 2620 N 850 W Shipshewana, IN 46565, 574-349-0210

HAY/STRAW/FEED

#1 Organic Certified Top Quality Hay & Balage, RFQ 200+ Nationwide Delivery! 🐼 Call to listen to the recorded updates on Organic Hay availability. 🐼 Buckeye Hay Co. 33656 Co Rd 126 Millersburg, OH 44654, 330-556-8221

Experience the Benefits of feeding Top Quality Western Alfalfa Hay with an RFQ of 200+! There truly is a difference! Using forage analysis, we're your #1 trusted partner for all things forage. Large & Small Squares. We deliver Nationwide. Buckeye Hay Co 33656 Co Rd 126 Millersburg, OH 44654, 330-556-8221

For Sale: Organic Hay, Balage and Dry Rounds 1st-4th cutting. Wrapped dried rounds, small squares 1st-4th cutting. 260-414-2897 or 260-409-0486

3rd and 4th cutting soft, green hay. \$7.50@ bale. Carlyle Martin 66227 Co Rd 9 Goshen, IN 46526, 574-862-4080

Hay For Sale! Rounds or big squares. Horse quality. Delivery Available. 989-657-4073

Large galvanized slow hay feeder. Used 1 year. \$500. 260-350-7677

Organic soybean meal and field peas sold by the semi-load. 610-273-9048

Quality Western Alfalfa pellets, 19%-22% protein, non-GMO and uncertified organic, great for all livestock, feed efficient, no waste, 1-ton totes, pickup dates every Tuesday, otherwise by chance. Edward Hershberger 16852 1 Mile Rd Morley, MI 49336

HEALTH/NATURALS

****Attention** Are you struggling with** (Bloating, Auto immune, Acid Reflux, Leaky Gut, Rash, IBS, IBD, Depression). To learn about the GI MAP Test call (VVHC David Keim Health Coach): 330-897-3232

A new release - HerHarmony Beauty Blend- from BioMinerals. The hype is real, but more importantly, so is the science. Not only does this product stimulate your own collagen, but it also balances your hormones. Great for women in all walks of life. A one month supply of HerHarmony Beauty Blend for \$68.84 or a 4 month supply at a 5% discount \$216.77 (Tax and shipping included.) To place your order, call or write today. NuLife 1390 Co Rd 600 Baltic, OH 43804, 390-845-4004

LIFEWAVE
STEM CELL ACTIVATING PATCHES
For blood sugar issues, inflammation, pain, brain fog, sleep issues.
Improves immune health, lung tissue repair, collagen production, hormone balance, bone health.
Supports cardiovascular health, nerve regeneration, free radical absorption.
(No drugs or harmful side effects)
The Fishers
214 E Mahantango Creek Rd. | (717) 365-9984
Herndon, PA 17830

BODY BALANCE 8qts-\$234.00.
OSTEOPRO CARE 4qts-\$185.00.
FREE SHIPPING. Miriam Ruhl, 1143 Briarwood Ln, Mount Joy, PA 17552. 717-653-4416



100% Dark Arabica Coffee with Lions Mane Mushrooms.
12oz Bag. \$34.50 + Shipping cost of \$9

Our rich, dark, ground Arabica bean coffee is filled with 100% fruiting bodies of Lion's Mane mushrooms. We grow our mushrooms in an open-air tunnel at the top of the Appalachian Mountains to ensure they absorb only the freshest air and contain no pesticides, herbicides, or other pollutants.



Pure Path Distribution LLC
P.O. Box 151
Emmitsburg, MD 21727
1-888-401-7747

Allergies? Listen to recorded testimonies of people who found relief from allergies without medications! 330-269-5254

COLON/GUT/ PARASITES/ DIGESTIVE ISSUES?? After having parasites, trying all-natural products for 12 solid years. then having bowel obstruction, discovered being filled w/parasites-organs looking like Swiss Cheese. A TRUE HAPPENING-ask me for full story! Our Colon/Parasite Cleanse designed to open parasite nests and destroy them! 1Mo Supply- Discount Price \$218.00. Ships Free. DON'T WAIT UNTIL IT'S TOO LATE!! Mattie Miller 6305 W US-20 LaGrange, IN 46761, 260-383-2077

Dairy, Gluten, or other Food Intolerances? Allergies often come from the Inflammation within our bodies. Get to the Root Cause with our Complete Digestive, Colon & Liver Cleanse. To better serve you, we will create an account so you can get wholesale in the future. Benny and Ida Troyer 1020 Pifer Rd Delton, MI 49046, 269-359-5711

Dried bee pollen for your health. Quart \$50. Gal. \$125. Free shipping on prepaid orders. Samuel Fisher, Homestead Beehives 141 Eco Ln Aaronsburg, PA 16820, 814-349-5157

Free Shipping/No Tax on Reign Napkins. \$6.00/pack. Every 25 packs get 3 free of your choice. 250 pack bulk deals available. Pay with check or card. Barbara Swarey P.O. Box 105 Bird-In-Hand, PA 17505, 717-572-3663

Great deal on NingxiaRed and Young Living products. 10% off your first order plus up to 3 free oils. 4 pack NingxiaRed, \$132.00, loyalty bundle, \$189.00. First 5 orders will be put in a drawing for \$50.00 worth of free products. Mary Fisher 2658 Mt. Pleasant Rd. Mount Joy, PA 17552, 717-201-9730

Have cavities? Tired of dentists? These products took care of infections and toothaches for us. After 6 weeks Dentist couldn't find any cavities. Includes: toothpaste, mouthwash, tooth-infection blend. Large family pack only \$172.00. Free shipping/tax. Rachel Nissley, 989-802-9502

HEALTH PROBLEMS? Your body is made up of 70-100 trillion cells, when your cells are healthy you're healthy! When your cells are unhealthy, disease and disfunction occur, and when untreated can lead to death. Science has shown that when your cells are unhealthy it is because of poor cellular communication. Damaged cells cannot alert the immune system, and the damage continues to multiply. For the first time in history you can bio-replace cellular communication. Learn how thousands of people are already experiencing medically improved health. Free information package. John Bash, 619-838-0493. 9AM-5PM

HiPP Bio Combiotic, HiPP HA Combiotic (sensitive), Holle Goat Milk, Pure Goat, and HiPP Goat Formula. All these formulas are the Dutch version. They are all organic and formulated without corn syrup, added sugars, or artificial additives. Large 28 oz. cans. UPS shipping. Wholesale Inquiries welcome! Marietta Mast 3527 Township Rd 184 Baltic, OH 43804, 330-763-0053

HUGE SALE ON SISELKaffe! \$35/ Bag or 4Bags/\$125. Fire & Ice-4Bags/\$160. SiselGut Enzymes-2Bags/\$76 or 4Bags/\$144. Call for all other Sisel Deals. Free Shipping on all orders. Anna Rose Lapp 520 Old Wilmington Rd Coatesville, PA 19320, 484-473-5296

SISEL products for sale, call me with your orders and I will ship to your door for FREE. Need something for fussy toddlers, struggling scholars, tired mothers, Lyme disease, or other health problems? Mention this ad for 10% off! Sarah Swarey 579 Barringer Rd Cherry Valley, NY 13320, 315-985-3980

THE Blooming THISTLE
Berlin, OH
330-403-3277

Enjoy Every Morning
With A Healthy Cup of
Moringa Hot Chocolate

EarthCup Moringa Hot Chocolate

February Products of the Month *Only* **\$79**

RESET. RECHARGE. RESULTS. START HERE.

Purple Tiger + Thyroid Complex + Meal Replacement
ONLY \$79 • SAVE \$11

**Excluding Autoships*



Live the VistaLife™
 PEOPLE. PRODUCTS. PROSPER.
 INDEPENDENT ASSOCIATE

Gene & Mary Beth Miller
 7370 W. 050 North
 LaGrange, IN 46761
 260-768-4722



Mama Bear & Kirkland Diapers, Free Shipping to your Door. Kirkland 1&2-\$37.00, Mama Bear-\$47.00. Both Brands, szs: 3-6-\$57.00. Wipes-\$27.00, Pullups-\$50.00. Kim Thomas 409 Creek Road Christiana, PA 17509, 610-780-8773

Shaklee Products. Chewable Vita. C, vitamin gummies, detergent, softener, stain remover, shampoo. 10% discount on cases. Amanda Lapp 45 Peach Ln Ronks, PA 17572, 717-687-7242

REIGN NAPKINS. Save big! \$6-per pack. Free shipping on 25+packs. Mix or match. Plus tax where required. No tax in MI. Buy 25 packs, get 5 free. 50-(12 free). 80-(20 free). All orders must be prepaid. Emma Herschberger 65000 Meeksville Rd McArthur, OH 45651

PRECIOUS TOTS DIAPERS AND SERENE COMFORT SANITARY NAPKINS! All products are natural, very absorbent, super soft, and TOXIN FREE! Diaper: \$48.00/case, plus shipping. Auto-ship saves \$2.00/order. 4 packs case, sizes 1-5. NAPKINS: \$5/pack, 10 or more, free shipping, 10% case discount. (48) Sizes Xsmall-Xlarge. KY residents add 6% tax. Cash or Check. **WHOLESALE AVAILABLE.** T&L Enterprises 2903 Logsdon Valley Rd Munfordville, KY 42765, 270-218-8320. F. 270-514-5715. tlenterprises@YCmail.net

Sleep better with grounding mats, also helps with inflammation and pain, free information. Nuthatch Naturals 6911 Washington Rd Clare, MI 48617, 989-418-1351

SHAKLEE/MODERE: ask about free gift, shipping, and distributor price. Independent Distributor. C&A Sales LLC. 5488 Township Rd 401 Millersburg, OH 44654, 330-893-7515

Sisel Products for sale, need something for your child in school? Or immune booster? Give us a call, we have testimonials and product information to send out with your orders, spend \$300.00 and receive a free gift with a value of \$30.00 or more, mention this ad to receive your free gift. Free sign up in Nov. and Dec. plus get \$100.00 of Free products of your choice when you buy a wealth builder pack. Sarah Swarey 579 Barringer Rd Cherry Valley, NY 13320, 315-985-3980



LION'S MANE (60 CAPSULES)
\$34.50 +
 Shipping cost \$9

Pure Path Distribution LLC
 P.O. Box 151
 Emmitsburg, MD 21727
 1-888-401-7747

- Premium Lion's Mane Mushrooms.**
- US Grown in the Appalachian Mountains
 - 100% Fruiting Bodies
 - NO Filler's
 - NO Heavy Metals (Third party Tested)
 - Small, easy to swallow capsule



Toilet Paper
Paper Towels
Energy Drinks
Aerosols
 bug spray, window, auto cleaner, lubricate
Organic Foods
Banana Boxes
Cheese, Frozen Foods
 FTL or Pallets 6 plt min

Bargainmax, Inc
704-612-9794 Sales
704-277-8007 Doug
 Items above can be in/out/Sht Dted

Reign Sanitary Napkins \$6.00/each package. Free shipping on any order. Sales tax may apply. Free info & samples. New customers welcome! Call or write, Martha Hochstetler, 60026 Nottawa Rd, Centreville, MI 49032. 269-467-4034

Showtime 1gal/\$65.00, 5gal/\$255.00, four 1 gallons/\$220.00, shipped. Add 7% tax in Ohio. Cephas Miller, 5488 Township Rd 401 Millersburg, OH 44654. 330-893-7515

Special: Sisel coffee, 8 bags for \$220.00. Sisel products at distributor prices. We will do our best to help you with any health problems. Free shipping. Rachel Stoltzfus 52a Old Leacock Rd Ronks, PA 17572, 717-537-8056

Want the best deals with Young Living? Call or write and we will help you find them! Anyone placing an order now thru February will be placed in a drawing for a 4 pack of Ningxia Red. Liz Petersheim 7081 Colebrook Rd Palmyra, PA 17078, 717-368-2604

What if by being on a prenatal plan daily could save you from low iron levels, fussy babies, low energy, and nausea in pregnancy? Support your body with Sisel's Prenatal Support Combo Pack! BalanceD, Encompass 360, Calcium K2, SupraOmegaPlus. It has your vitamins, minerals, omegas, and calcium and can support your body to have a healthy pregnancy, delivery, and vibrant, healthy babies. Buy the bundle for \$199.00 get free shipping. Receive free pregnancy booklet/free samples of Sisel's Digestive Enzymes which supports healthy iron levels and digestion. Daniel & Anna Rose Lapp 520 Old Wilmington Rd Coatesville, PA 19320, 484-473-5296

Y.L. special through February! Ningxia Red family pack comes with 4 bottles and 30 two oz packets for \$194. plus \$25. back and free shipping! Comes with free account, 2 free oils, monthly newsletters, etc. No need to order again. BarbiEda King. 717-803-1102

WEIGHT LOSS! Are you struggling with weight management? GLP-1 weekly injections are extremely effective for weight loss. Most people lose 15-30 lbs in 8 weeks or less. Call for more info. 814-547-2177

Will be doing Shockwave Treatment. Good for pain relief, elbow, shoulder, back pain. Do your feet hurt? We have had good results. 1110 N 675 W Shipshewana, IN 46565, 260-350-8150

HELP WANTED

Looking for a highly motivated crew to construct Agricultural and Residential buildings in the state of Michigan. Competitive wages will be offered and would be looking to keep you busy weekly throughout the year. 419-678-4198. Ask for Ryan

Yoder's Country Market is looking for a few committed employees for 2026! A variety of jobs including cashier and bakery. Room and board provided. We are located in the beautiful Big Horn Mountains in Buffalo, WY! 369 Trabling Rd Buffalo, WY 82834, 307-752-1814

Ganoderma Coffee
By the case (mix or match)

Ganoderma 4-in-1	40 boxes (20 pkts)	\$10.50
Ganoderma 2-in-1	75 boxes (20 pkts)	\$10.50
Collagen	39 boxes (15 pkts)	\$10.50
Cappuccino	31 boxes (15 pkts)	\$17.50
4-in-1 Premium	28 boxes (20 pkts)	\$11.50
Avarie 3-in-1	30 boxes (20 pkts)	\$11.50
Avarie Classic	50 boxes (20 pkts)	\$11.50
Cafe Avarie Mocha	30 boxes (20 pkts)	\$17.50
Cafe Avarie Radiance	30 boxes (15 pkts)	\$15.00
Cafe Avarie All-in-one	30 boxes (20 pkts)	\$12.50
Cafe Avarie Black	50 boxes (20 pkts)	\$12.50
Cafe Avarie Cocoa	30 boxes (20 pkts)	\$15.00
Cafe Avarie Vanilla Dream	30 boxes (15 pkts)	\$15.00

5-9 cases: \$10 off per case
10 or more cases: \$20 off per case
(Sent to one location)

FREE shipping on full prepaid cases < > We can send samples at your request < >

(Please include phone # with order)
Prices are subject to change without notice

We can mix or match any variety

Send check with order to:
Shady View Farm
Jacob & Katie Yoder
279 Bartges Road, Coburn, PA 16832
814-349-5354 x2
No phone payment available

Blooming THISTLE
Berlin, OH
330-403-3277

What is EarthCup Creamer?

- ✓ Infused with Collagen Peptides
- ✓ No Sugar
- ✓ No Artificial Flavors
- ✓ Healthy
- ✓ Taste's Amazing

HOUSEHOLD/ FURNITURE

2 - 21cu.ft. LP black refrigerators. Like new. China cupboard and desk with medium stain. 6 panel oak doors. Fiberglass dog boxes. New black garage door, 8x12. White garage door, 8x12. Call for more information, 260-433-4937

3 y/o Premier LP gas kitchen range works good. \$500. 9785 Tobacco Dr Clare, MI 48617, 989-339-7244

4-piece bedroom set in good condition, dark cherry, lots of storage room, \$400.00 OBO. 260-214-4359

Beautiful China Cupboard, \$750.00 OBO. 260-657-1090

Custom Finishing woodworking, kitchens, baths etc. Short lead times. Call for free estimates. Eastside Creation 61400 Middle Colon Rd Burr Oak, MI 49030, 269-503-2241

Deluxe 65" solid oak treadle sewing machine cabinet. Medium brown stain. Has lift, pocket doors, and 6 drawers. Never used. \$2,300.00 OBO. 260-498-4342

DS COAL STOVE, Excellent Condition, \$500.00. 260-417-1990

For Sale - MATTRESSES. New 7-inch, solid core, firm foam mattresses. (Firmness and density similar to an ABC mattress.) High quality, CertiPUR-US certified foam. Typical life of 12-18 yrs. per side. One side- firm. Other side- extra-firm. Free shipping. Twin \$300. Full \$375. Queen \$400. King \$450. Titus Schrock S4078 Chicken Hollow Rd Hillsboro, WI 54634

Oak Table and 4 chairs w/8 leaves, open up to 14', \$900.00. Ashland Kitchen stove w/glass top and natural gas burner that can be converted to wood or coal, \$500.00. 260-466-0178

For Sale: 2 queen beds w/ mattress, good condition, \$150.00 each. 1 full bed w/ mattress good condition, \$125.00. Non-reclining tan couch, good condition, \$200.00. Electric refrigerator 15 cu.ft, \$200.00. Larry Yoder, 574-546-2733

Hundreds of Train photos available. As seen in Trade Express; Trains across America and other publications. Create your own company calendars, puzzles, wall art, Christmas Cards & More. Send \$75.00 for 500 Thumbnails on a USB drive. 6 different drives available. Harold Walters 5 Martin Circle Denver, PA 17517, 717-615-2834

White 18cu. ft. gas fridge/freezer, good condition \$1,000. 574-914-1079

Rolltop desk in like-new condition. \$1,200.00. China Hutch very nice \$800.00. FREE delivery anywhere. 517-212-6995. Phone number has been updated

Solid Maple Kitchen/Dining Table w/leaves. 48" wide, opens to 12' long. 2 matching 8' benches. \$1,500.00 OBO. Call 260-210-4398

LAWN & GARDEN

26" Cub Cadet snow blower, works. \$350. 9785 Tobacco Dr Clare, MI 48617, 989-339-7244

6'x6' shiplap sided shed on skids, metal roof and 4 2'x2' windows, brand new. \$1500. 74 Schaller Rd Transfer, PA 16154, 989-802-1606



PUT YOUR NAME HERE

Insulated Thermo Bag



Designed with convenient carry handles!

- closes with zipper
- pouch on front
- dimensions 8"H x 15"D x 19"W
- keeps hot 5+ hours

Thermo Bag Order Form

Name _____

Address _____

City, ST, Zip _____

	Qty	Price	Total
Burgandy _____	1	\$89	_____
Black _____	1	\$89	_____
Charcoal _____	1	\$89	_____
Tan _____	1	\$89	_____
<i>Ohio Residents add 7.75% Tax</i>			
Shipping \$15.00			
Total _____			

Mail order and check to:
Mound Country Store

ORDER YOURS TODAY!

Mound Country Store

30315 County Road 12 | Fresno, OH 43824

740-502-9623

Wholesale Inquiries welcome

Dutch soil concentrate 100% naturally designed for soil, seed plants, and a stronger root system. Increase yields, sweeter veggies and fruits. Works great for grass-fed famers. Increase growth and yields on hay and corn. Pint \$18.00 shipping \$8.00. Quart \$29.50 shipping \$8.50. Gallon \$86.00 shipping \$12.00. OH residents add 6.75% sales tax. Schlabach Supplies, 8908 Barrs Mills Rd. NW, Sugarcreek, OH 44681. 330-897-0150

WHISKEY BARRELS
Beautiful Solid Whiskey Barrels and also Half Barrels for Flower Planters.
10% off Feb. 16-March 16
Call for pricing:
Ph. 260-214-5125 • Fax 260-214-5126
— DEALER INQUIRIES WELCOME —

Kubota BX-2230 sub compact tractor. 4WD, 3-point with quick attach, new battery & headlights, has a Brush Hog, disc, front blade, 1-bottom plow, lawn roller, & trailer. Good condition, \$9,950.00 OMO. 30591 Coohon Rd Colon, MI 49040, 269-689-6818

Need privacy? Pine, Spruce, and Arborvitae seedlings. Write for a free catalog. 6350 E Messner Rd Apple Creek, OH 44606

Non running wheelhorse tractors for fix up projects, also lots of attachments snowblades, snowblower, garden plows, and garden discs. 260-535-0955

Spring fever? Get your order in now for landscaping, trees and shrubs! Privacy, shade, and color for your home. White Pine, Norway Spruce, Green Giant Arborvitae, Maple trees, Dogwoods, and much more. Ask for free catalog. Miller Trees LLC 21470 Swendal Rd. Butler, OH 44822, 740-507-8067

LOST & FOUND/ FREE ITEMS

Found: An umbrella and a wristwatch at the corner of 300 W and 400 S on Monday January 12, owners pick up at Enos Girod 4515 W 350 S Berne, IN 46711

Free 32x56 hip roof barn with 32x20 lean to you tear down. Grabill, IN. 260-466-5013

Free block silo for the taking. You remove. David Lengacher 15813 Spencerville Rd. Grabill, IN 46741, 260-750-3253, or 260-750-3489

Lost unmarked dark blue headscarf was fairly new. Amos & Lucinda Graber 3806 E 500 S Wabash, IN 46992

MAPLE/ MAPLE SUPPLIES

18"x63" Dominion& Grimm Evaporator. New in 2024. Like new condition, good for 150-175 taps. Can ship. \$4,800.00. Roman Stutzman 8811 S Brand Ave Clare, MI 48617, 989-802-1751

2x6 Evaporator, stack & stack cover included, available after 2026 season. \$7,000.00. Lyle Bontrager, 574-312-3679

5 gallon new buckets. 180 buckets/lids per pallet. Food grade, 90mil. Simple Life Soap LLC, 717-696-5600

Airablo vacuum pump, 3hp, \$3,000.00. 32gal Sunrise water jacketed canner with stand, burner, \$2,500.00. WesFab 7", 8 bank filter press with spare pump, \$1,800.00. Larion Helmuth 3013 Birch Rd Bremen, IN 46506, 574-276-5488

Maple syrup hobby evaporator pan, size 24x36, no drop flues, good condition, from Sunrise Metal. Sam Eicher 1057 Paul Rd Montgomery, MI 49255

Maple Season is HERE! Some in stock evaporators, custom flat pans, mainline and tubing in stock; buckets, sap bags. FREE Shipping on full skid jugs. Maple Crest Sales, Penn Yan, NY. 315-536-0957

MISCELLANEOUS

120psi 35gpm air operated double diaphragm pump w/ air regulator, like new. \$700.00. 100psi 13gpm Aro Ingersoll Rand used air pump, \$200.00. 260-466-0178

14x32 Single Story 5-Room Cabin from Eash Sales, w/6' porch. Inside loft, upper/lower cabinets, \$35,000.00/OBO. 260-723-4436

18"x18" Durable Poly-wood hanging Cloth-dryers with 36ct Poly-Pins gray, blue, green, brown, or pink \$48.00 each, 3 for \$125.00, 10 for \$350. Free Shipping. Roman Troyer 1036 Township Rd 1193 Ashland, OH 44805

25pc Makita set, 3 impacts, 2 drills, 3 impact wrenches, 7.25" circular saw, recip saw, orbit sander, blower, multi-tool, string trimmer, grinder, 10" chop saw, 3 flashlights, 2 kitchen lights, 4 batteries, 4 chargers. Selling everything for 1/2 price of new! Free delivery. 717-949-2626

!!! Amtrak timetables, (Updated), train calendars!!! Maps, Atlases, Globes, School maps. Ask for FREE catalog! Crossroad Map Sales 41 W Eby Rd Leola, PA 17540, 717-478-7013

Enterprise Lard Press collection. All sizes. Mostly all complete. Price from \$150 to \$250. Daniel Hochstetler 9795 Larue-Mt Victory Rd La Rue, OH 43332

For Sale: Steel wheeled chop buggy with canvas to close in the back (in great condition). Trash pump (in working condition) Call: 260-450-4234

CLASSIFIED DISPLAY ADS IN COLOR!

Ask Us How!

Call The Office @ 574-501-5105
ads@busybeavermi.com

7x7x8”H Walk In Panel Freezer w/floor, works good, \$3,500 OBO, 6772 S Mt Eaton Rd Dalton, OH 44618, 330-287-8176

For Sale: Mod 1816 Case skidloader with 34” bucket and new 22 HP Honda U-Twin engine. Ideal for cleaning out boxstalls. 260-705-4172

SS canners, brand new, 3 left. \$160 each plus shipping. Dan Schwartz 1161 S 200 W Monroe, IN 46772

United Voicemail- developed for the Plain Communities. Single mailbox or multiple extensions. Add to any black box, keeping your service and phone number for easy setup. Fast, simple features for you and your callers. Call Central Phone at 260-535-5525. Experience the difference!

FIRE PROOF FILE CABINTS:
FireKing 21inWx31inD 4-drawer.
FireKing 37inWx22inD 2-drawer.
Hon 20inWx25inD 4-drawer.
Hon 31inWx22inD 4-drawer. Delivery possible. Yoker Valley Variety 59529 Yoker Valley Rd Quaker City, OH 43773, 740-679-2229

Label printer Dymo Rhino 5200 up to 4 lines. Large memory, great for addresses. \$150. Free shipping. Zimmerman’s Archery 25606 Friendship School Rd Mechanicsville, MD 20659

★★★★ 770+ Lots ★★★★★
Bart Select Book Auction
Saturday, March 21st
Including some older **HARD to FIND, Good Quality Books!** You don't want to miss this Exciting Auction. All lots are **hand selected** by the Committee, Probably the best selection ever sold at Bart, Call for our free 32-page catalogue or to place absentee bids
717 789 7026

OFFICE SUPPLIES/ PUBLICATIONS

Collection of old Books, Bibles, Martyrs Mirror, etc. Send self addressed stamped envelope for description and price List. John’s Book Repair 10438 Kidron Rd Fredericksburg, OH 44627

PRODUCE/EDIBLES

Carrots For Sale and Potatoes and More !! Free shipping to your door. All Chemical Free Veggies for sale year round... Excellent Flavor. No pesticides or herbicides ever, at Root Stream Farm. 717-522-9666

For sale! Fresh brown non-GMO eggs, \$3.00/ dozen. Mahlon Yoder 8075 S 750 W Topeka, IN 46571, 260-593-0065

Garlic and Onions.... Got the Flu??!! Try nature’s all natural antibiotics and flu fighters. Garlic and Onions.... Then Detox with Red Beets or juices!! Carrots, Radishes and More, Chemical Free produce, with Free Shipping anywhere.... Call 717-522-9666

Looking for new lithium batteries for solar system? 3 sets EG4 100-amp hours, 6 in a set, in a case stack w/roll around casters for a 48V system. 8-year warranty left. Call for pricing. Located in Spencerville. 260-564-9316

Mid-sized GMG pellet grill, less than 1 y/o, used 3 times. \$450. 9785 Tobacco Dr Clare, MI 48617, 989-339-7244

Notice, Electrical Rebuilders Workshop, February 28th. Dayton, VA, topics & roundtable, 4th annual rebuilders, help network meeting. 574-892-5968

Stanley Home and Fuller Brush Products. Call to order or for FREE catalog. Miriam Ruhl, 1143 Briarwood Ln., Mount Joy, PA 17552. 717-653-4416

Rubber Office Chair Wheels
super smooth and quiet.
Will not mark or scratch floors
fits 99% of office chairs
Can ship anywhere in the USA

\$33.00 a set
free shipping on 5 or more sets.

DJ Services 260-293-0635
1880 N 100 W Lagrange IN 46761

Taking orders for hardy Crimson Red Rhubarb roots. Will dig this spring. Delivery available. \$4 each. 100 or more \$3.75. 500 or more \$3.50. 1054 Maytown Rd Elizabethtown, PA 17022, 717-361-6050

Grape Juice Concentrate for Sale.

Mix 1 cup Concentrate to 1 Gallon water, add sweetener to desired taste. \$30.00/Gallon. Also Organic Idaho Vinegar, Full Strength, not diluted \$13.00/Gallon. We Ship. A&E Maple 22375 Hostetler Rd Danville, OH 43014. 419-512-0067

Imagine Fresh Garden Goodies

all year... Or Right Now! Let us be your trusted source for Flavorful Veggies. Only a few buttons away!! Call us for full details or ask about our automatic/scheduled "Free Delivery!" Large selection of Fresh, All Chemical Free Veggies/Goodies for sale all year..... Call Root Stream Farm today, 717-522-9666, to get yours

Maple Syrup \$40.00/Gallon,

Honey \$45.00/Gallon, Sorghum \$28.00/Gallon. All sizes available for stores and farm Markets. Also available in Buckets and Barrels. Great Delivery and shipping options available. A&E Maple 22375 Hostetler Rd Danville, OH 43014, 419-512-0067

Pure raw honey, light colored

clover, wildflower. 5 gallons, \$175 plus shipping. Abraham Renno 128 Pinckney Rd Rodman, NY 13682

We have Einkorn and Spelt flour,

cornmeal and puffed spelt. All our grains are non-gmo. We are looking for Einkorn, will do custom milling a minimum setup charge of \$12.50. Please call or write for more info. The Flour Shack 10041 State Rte 138 Greenfield, OH 45123, 937-946-3471

**PRODUCE EQUIP/
SUPPLIES**

Sale on S&L cultivators, 4% if ordered by 3-1-26, 7% if paid by 3-1-26. Mtn Top Farm Shop 4794 Long Run Rd Loganton, PA 17747, 570-725-2228

Conveyor belts of all types and sizes. Food grade is available. CK Beltco 7724 Banks Rd Gainesville, NY 14066

Pet Pete #2000 plastic Lifter

Wrapper steel wheel like New \$1450.00. Hogback Transplanter #1802 steel wheels \$2350.00 Like New. Ultimate Finish plastic layer steel wheels like New \$2550.00. Johnnie Wagler 8652 County Rd 8-50 Montpelier, OH 43543

"Revolver" A Small, Family Scale,

Cost Effective, Rinse Action Washer. For diversified produce Farm(er)s or anything else. Affordable, User friendly, and Extremely Efficient washing for anything that You might have to Rinse/Wash. Easy one person operation. Call 717-354-6766 x4

**REAL ESTATE
(FOR RENT)****FL Ocean Wake home, newly**

renovated. 4 bed, 3 bath, in the heart of Pinecraft Borders golf course, 7 day min. Beach chairs, two electric trikes, two electric bikes, two trailer carts. Available late March, sleeps 8. Three kings, one bunk. Call to discuss, 717-471-1993

**REAL ESTATE
(FOR SALE)****116-Acre Osseo, MI farm with 3**

bed/3bath/finish basement, 30x70 pole barn, tillable fields, timber, food plots, creeks, recreational/hunting habitat. \$1,499,000. 517-320-3227

7.89 acres near Waldron Lake,

in Rome City, IN, woods and bare land, potential building site, older bank barn enrolled in Heritage Barn Tax Exemption, flowing well, 3 hunting blinds, abundant deer & turkey. 260-585-7807

54 acres for sale. 20 acres tillable the rest in timber. Asking \$385,000.00. Pittsford, MI. on Prattville Rd. James Graber, 260-750-0252

For Sale: 55 acre Fredonia, PA

Horse Farm. Rare opportunity to buy a very nice farm within the Amish community. Lots of options, currently set up for horse boarding and training but would be excellent for dairy or produce farming (could be organic) Quiet location, but close enough to main road for any type of business. Good Hunting! Look for full page ad in Busy Beaver Extreme in December 23rd & February 20th issues. Contact: Joel Brenneman 294 Cochran Rd Fredonia, PA 16124, 724-475-3030

RENTALS**E-Bikes, E-Scooters, 6-Seater Golf**

Carts, and Mopeds can be rented at the Pinecraft ice-cream shop. John Bontrager, 260-600-1647

Guest house for rent, within one

mile from Mt. Hope Auction Grounds. One bedroom or 6 bedrooms. Night or weekly rates. Call Grace Yoder 7530 Township Rd 362 Millersburg, OH 44654, 330-674-1844

Need a place to stay? Small house,

2 bedroom, 2 bath, plus more beds available. Located between Mt. Hope & Kidron area. 330-390-9342

SAWMILL EQUIPMENT**1500 Morooka prehauler. Tracks**

70% rebuilt finals and pumps. New pivot bearings and bearing housings: New roller triangles. 5.9 Cummins engine hood loader, total over haul. Don't have time to finish. \$40,000.00 OBO. 440-983-9481

Conveyor belts in stock. Ship

UPS daily! Call or write for price. CK Beltco 7724 Banks Rd Gainesville, NY 14066, 585-567-2358

10 hp single cylinder diesel, pull start, NEW, \$1,275.00. 20hp Yanmar 3TNV70 power unit, 69hrs, radiator, stub shaft, and panel, \$3,500.00. 45hp Kubota V2203 power unit, new radiator, stub shaft, and panel, \$4,700.00. 150hp Cummins 6BTA 5.9L power unit, new radiator, clutch, and panel, \$10,500.00. 275hp JD 6081T power units, new radiators, clutches, and panels, 2 available, \$15,500.00. 300hp Cummins 6CTA 8.3L power unit, new radiator, clutch, and panel, rebuilt, \$15,900.00. 3-375hp power units, new, used, and rebuilt, CALL. Also Murphy shutdown control panels, \$399.00-\$639.00. 717-335-8181

Caterpillar D4H TSK Dozer with arch and winch. Like new undercarriage. Lots of new parts. New torque convertor and new radiator. Motor in excellent condition. New hydraulic pump, service records available. Ready to put to work. \$70,000.00 OBO. 440-632-9562

Diamond and CBN Grinding wheel recoating. We resurface worn Woodmizer, and all brand stones in Michigan USA since 1985, with Virgin Diamond and CBN. Call 248-280-1185. Ship to Dianamic Abrasive Products Inc. 2566 Industrial Row Drive Troy, MI 48084. Discount for first time customers only

For Sale: Caterpillar D4H TSK Dozer w/arch and winch; New undercarriage. New rebuilt transmission. 0 hours on complete rebuilt motor. Call for pictures. \$90,000.00 OBO. 440-632-9562

Slab Muncher 160, 6x16in capacity, \$8,000.00. 812-289-1599

Woodmizer LX450 For Sale. 1906 hrs. 35H Yanmar Diesel. Like new condition. \$39,500.00. Jerry Miller, 406-374-2770

SERVICES RENDERED

Get your business found on Google. Start w/free online search demand report. 717-327-5228

Travel by train? Will get Amtrak tickets for You! Can mail, fax, email or by phone. 7-AM to 5-PM Eastern time. Andy Weaver 15240 Wynncrest St SW Navarre, OH 44662, 740-501-3531

SHOP/TOOLS

14in shop box bansaw, new in 2020, flex shaft ready, \$800.00 OBO. 260-301-8239. Ask for Matt

210hp Cummins, 800hrs, coolant used as floor heat. \$10,000.00 OBO. 812-289-1599

2017 S500 three phase Nederman blower, \$5,800.00. SCMI 24" wide belt sander, \$3,000.00. Machines currently in use, ready by end of February. Stanley Martin 2663 Townhall Rd Stanton, MI 48888, 989-763-7663

All types of conveyor & drive belts available. Moulder & planer belts & more. CK Beltco 7724 Banks Rd Gainesville, NY 14066, 585-567-2358

Cable clutches, still buying them from your big suppliers? Give us a try. Free shipping on all clutches. Retail, wholesale. ADK Hardware and Supply 241 Wilson Road St Regis Falls, NY 12989

For All your Metals, Salvage & Surplus needs



610-921-8848
Shipping Available



Wysong Hydraulic Press Brake,
Wysong Press Brake 100 Ton,
Model # MTH100-120,
Stoke 8, Adjustment 9,
does have a back gauge, \$20,500



Toyota Forklift,
10,000 Pound Lift Capacity,
Model # 52-6FGCU45, 11265 Hours,
Gas or Lp, Solid Tires, \$13,000



Chicago Dreis Break,
Chicago Dreis & Krump MFG Model # S-1018,
Up To 18 Gauge Capacity, Bending Length 10' \$3200



Kobalt Air Hose Reel,
Kobalt Retractable Air Hose Reel,
Maximum Working Pressure
350 PSI 3 available \$60. Each



Philadelphia Cardboard Baler, Philadelphia Tramrail Vertical,
Hydraulic, Cardboard Baler 30"x60" Chamber,
Vertical hydraulic cardboard baler / trash compactor,
Hydraulic compression for consistent, dense bales \$5,700



304 Stainless Steel Sheet,
Stainless Steel Sheet Size
.185"x60"x120", 388 Pounds
Per Sheet 20 Pcs Available \$2.00
Per Pound \$776. Per Sheet

Century 50-amp plasma cutter, 230v single phase, 18ft torch, cuts up to 1/2" metal. Comes with extra consumables. In working condition. \$300. 574-364-8541

Baileigh dust collector, 2300CFM 3HP 220V 1PH, like new. \$1,200.00. Shop Fox dust collector, needs bags. 1.5HP 1 PH, still works. \$100.00. Powermatic 15" HH planer, 3HP 1PH 230V, like new, \$2,500.00. Powermatic jointer mod.60 1.5HP 3PH 220-240V, fair condition. \$1,000.00. Mitsubishi 17KW generator diesel motor in 4'x6'8" trailer. 2556hrs, excellent condition. \$9,000.00. 260-466-2358

Electric 10" Bosch 4100 XC table saw with rolling stand. \$500 OBO. 74 Schaller Rd Transfer, PA 16154, 989-802-1606

Electric air compressor 125 PSI \$150.00. Larry Yoder, 574-546-2733

Insert Shaper. Cutters for stile and rail mini shaker doors. like new condition. 1.25in bore. Have new inserts. \$1500obo. Hershberger Woodcraft 10830 Washington Rd Clare, MI 48617, 989-386-4478

For sale 5 hp Honda motor, with auto start, reg. gas, also 119 gal. bladder tank, and F&W pump, everything was used only 3 yrs. \$1350 or will sell items separately. Jay Miller 7715 W 400 S Topeka, IN 46571, 260-293-1228

Kremlin 10 C-18 pump system with Xcite spray gun, pump works but too small. \$1500 OBO. 812-528-7123

Red cedar lumber, live edge or straight edge, cut to your desired thickness \$1.50 a ft. any amount. Levi Hostetler 5080 Forman Chapel Rd Mayslick, KY 41055

SPECIAL EVENTS/NOTICES

Deluxe 65" solid oak treadle sewing machine cabinet. Medium brown stain. Has lift, pocket doors, and 6 drawers. Never used. \$2,300.00 OBO. 260-498-4342

NOTICE: We got a cash/paid order before Christmas, but no contact info. We are trying to find this customer. Please Call: Yoker Valley Variety 59529 Yoker Valley Rd Quaker City, OH 43773, 740-679-2229

2026 Tours: Feb 23rd-March 7th. Our annual winter tour to explore the state of Florida. Some highlights include a stop and tour of Samaritan's Purse in North Carolina. A lunch cruise in Savannah, Georgia, and a stop at the World Equestrian Center in Ocala, FL, before traveling to Sarasota for the weekend. The next week we have an airboat ride out to an Island where some Indian ladies make a meal for us. All the way south to Key West before traveling home through St Augustine, FL. May 4th-16th. Texas Tour. We explore the state of Texas. Some highlights include a tour of Palo Duro Canyon, a Chuckwagon Meal at Cowgirls and Cowboys of the West, a tour of King Ranch, the largest ranch in the US..., a dolphin tour, a guided tour of Houston, plus much more. May 25th-30th Our DC tour where we have a step-on guide, plus on south to the Outer Banks in NC where we have a hotel right along the beach. We'll do a wild horse tour and a dolphin tour plus more. On the way home we spend some

Drill Bit Organizer Kits

Part # 102077 \$135.

Part # 102075 \$185.

Also available without Mounting brackets

Drill bits Not included

Wholesale inquiries welcome

Smoker Fab PH# 717-529-6915

Save the Date

9th Annual Plain Community Pallet Shop Get Together

July 16th and 17th 2026

Location:
The Ekklesia in Harlan Harlan, IN

Watch future ads for more details.

231-825-2884

time in the beautiful Shenandoah Valley among the Horse and Buggy Menn community. I'm still working on brochures for our Northeast Tour-all the way to Prince Edward Island and Nova Scotia from June 29th-July 17th, and our Northwest Tour from August 3rd-22nd. Call or write for more information. Swiss Valley Tours PO Box 552 Sugarcreek, OH 44681, 330-852-3898

3 yr Morgan x Hackney pony. Vineyard Road Auction bound Sat. March 21st! A 56" buggy pony with lots of drive & stamina, fancy, a young boy's dream. For more info, write: Crist E Miller 227 A Logtown Road Fultonville, NY 12072

M+L Portable toilets, new and used units for sale. Info: 260-213-1641

Tupperware Thatsa Jumbo Bowls in stock for \$20 each, plus shipping and tax. Color red. Also have some other Tupperware in stock. Leander and Fannie Keim 3624 S Caledonia-Ashley Rd Cardington, OH 43315, 740-262-8301

SPORTING GOODS

12-gauge Browning Gold Hunter 3.5" awesome goose gun. \$1100 OBO. 74 Schaller Rd Transfer, PA 16154, 989-802-1606

22 LR Marlin Model 25. bolt action, micro groove barrel, and 10 round clip. \$500 OBO. 74 Schaller Rd Transfer, PA 16154, 989-802-1606

ATTENTION Bow hunters and archery enthusiasts: 3D Archery tournament at Honeyville Auction Center on Saturday, February 28th. To sign up or for more info, call Backcountry Outdoors, 260-564-6660

Chestnut, Persimmon, Apple, and Pear trees for wildlife. Write for free catalog. 6360 E Messner Rd Apple Creek, OH 44606

Eagle Claw 2-man ice fishing tent. Good condition, \$200.00. Jesse Borkholder 16620 State Road 120 Bristol, IN 46507, 574-354-9267

Hunting blind, 7.5ft square, perfect for the field, insulated, \$2,000.00 OBO. 574-354-3214

For sale Scout 44 mg with Simmons scope. \$500. 260-293-1228

CVA WOLF muzzleloader 50 cal. break barrel. \$240 OBO. Darton compound bow 47 lb. draw weight, comes with 5 pin sight. \$60 OBO. Wards western field, 22 cal. bolt action, long or short rifle. \$140 OBO. Good condition. Roman Troyer 7824 SE ST Road 116 Bluffton, IN 46714, 260-227-1246

Good used older 2-stroke outboard motors. 5-1/2 to 50hp from \$200.00 to \$1,500.00. Schrocks Marine, 260-463-8126

Hoyt carbon RX9 RH 65 lb. draw length adjustable Realtree APX. Regular price \$2099. Clearance \$1450. Free shipping. New in box. Also more Hoyts in stock. Zimmerman's Archery Pro Shop 25606 Friendship School Rd Mechanicsville, MD 20659

New Berhara 17 HMR, Garmin 67i GPS Vortex pro scope rings 30 mm low. Merle Miller, 574-642-1254 x6

ADS DUE!	ISSUE DATE
Jan 16	Jan 24
Jan 23	Jan 31
Jan 30	Feb 7
Feb 6	Feb 14
Feb 13	Feb 21
Feb 20	Feb 28
Feb 27	March 7
March 6	March 14
March 13	March 21
March 20	March 28
March 27	April 4
April 2 <i>Early!</i>	April 11
April 10	April 18
April 17	April 25
April 24	May 2
May 1	May 9
May 8	May 16
May 15	May 23
May 21 <i>Early!</i>	May 30
May 29	June 6
June 5	June 13
June 12	June 20
June 19	June 27
June 26	July 4

Ruger American 6.5 Creedmore, \$650.00. Savage Axis w/scope 30-06m \$550.00. Savage 111 .270, \$525.00. Savage 110 .270, \$600.00. Weatherby Vanguard 22-250, \$750.00. Browning Abolt .270 stainless barrel, \$1,275.00. Stevens 555 12ga Breakopen, \$550.00. Bergara Premier w/ Zeiss conquest scope 7mm Rem mag, very nice, \$2,200.00. Alan, 260-216-1072

Pop up camper, NICE, new roof, very roomy, \$2,500.00 OBO. 574-354-3214

PSE Drive 3B righthand compound, comes with release, 9 arrows and Tarantula case. \$850 OBO. 74 Schaller Rd Transfer, PA 16154, 989-802-1606

Snares, snare cable, and snare locks. Snares made with 3/32, 7x7 galvanized snare cable. For Coyote, bobcat, fox, and more. Ready made snares, \$15.00/dozen. Or \$110.00/100. 3/32 7x7 galvanized snare cable, \$10.00/100ft roll. \$35.00/500ft spool. Or \$60.00/1000ft spool. Medium micro snare locks \$28.00/100pcs. Prices valid until Feb 28, 2026. Shipping rates: totals up to \$50.00, \$12.10. \$51-\$100 orders are \$21.15. \$101.00-200.00 are \$30.20. \$201-\$400.00 are \$45.30. \$401-\$600.00 are \$60.00. \$601.00+ are \$70.00. Ask about other trapping supplies. Make checks payable to Eli Hoover.

Include phone number if available. Eli Hoover 1476 Kiper Rd Leitchfield, KY 42754. Please indicate where you saw this ad

Remington Wingmasters, 12 gauge, Remington 1100 12 gauge. 260-535-0955

Thermal monoculars with 1200 yd. range finders, 1400 yd. range. \$1350 free shipping. North Shore Optics 46408 8th Ave Bloomingdale, MI 49026, 269-521-3055



Business Cards

Custom Designed and Printed by:







- Affordably promote your brand
- Create a credible professional image
- Personally and easily give contact info

Black and White		Color	
1-Sided	2-Sided	1-Sided	2-Sided
250	\$32.00	\$38.25	\$39.00
500	\$41.00	\$51.00	\$46.00
1000	\$50.00	\$65.00	\$65.00

Plus Shipping, Standard Size, Cover Paper Stock, 100#. Design at an additional charge. All prices subject to change.

740-397-0262

19270 Scott Rd
Mt Vernon, OH 43050
Orders@pageonegroup.net

TRANSPORTATION/TAXI

Driver with 4-door truck, 4-horse slant trailer. Also, 32' flatbed, double axel dual. Local or long distance. Call Ryne Haller, 989-576-1757

"It's worth the ride." 12 passenger van \$1.10/mile. 4x4 Pickup truck, \$1.15/mile. Mini Van, \$.95/mile. 28 ft. tilt bed trailer, 10,000 lb. payload. 2-place horse trailer. Located in Howard City, Michigan. We can take you almost anywhere your heart desires. Marc, 231-250-9696. Patricia, 231-578-5255

WANTED ITEMS

Wanted used BCS tractor and tiller attachment good condition. 989-370-4855

Wanted: Pioneer 2 bottom plow 12", also powerline manure spreader, used. David Miller 4714 W Lily Lake Rd Harrison, MI 48625

WILL ORGANIZER

**The timing may be uncertain,
but your responsibilities are not.**

- Who will raise your children? What will happen to your things?
- Make intentional decisions about your children and other less-important assets.

• You haven't done it yet because you haven't decided to do it.

Call TODAY and ask for your complimentary Will Organizer.



I hereby declare that this is my last will and testament, and that I have made it of legal age and of sound mind and memory, and that I am expressing my wishes without undue influence of any person.

I, the undersigned, *[Signature]*



Anabaptist Foundation

55 Whisper Creek Drive
Lewisburg, PA 17837
800-653-9817 | info@atweb.org

3rd Annual Childless Couples Gathering

Hosted by: Stephen & Martha Schwartz



Saturday, August 8th, 2026 for lunch
David & Barbara Schwartz
18433 Bull Rapids Rd
Spencerville, IN 46788

If you're interested, please call or text
Dave Zehr 260-573-3303
Martha Zehr 260-333-5795



*Come early! Come Friday!
Local businesses will be open, metal shops, sawmills, buggy shops, etc.
Tours available. Call Dave for details.*

*Doors open at 10:30
Lunch starts at 11:30*

**GOD GIVES EACH AND EVERY ONE OF US
A DIFFERENT JOURNEY IN THIS LIFE,
AND SOMETIMES IT FEELS GOOD
TO SPEND TIME WITH PEOPLE WHO TRULY
UNDERSTAND THE FEELING**

Col. 3:12 put on a heart of compassion, kindness, humility, gentleness and patience.

BENEFIT RAFFLE

For Widow Betty Hershberger

RAFFLE ITEMS

Ozark Mountains 1wk Vacation for 10 People *(Transportation Provided)*
 or **\$5000 Cash Option**
#S200 Spinning Wash Line
\$1000 Shopping Spree



TICKET INFORMATION

Tickets **\$20 ea** 6 - **\$100** or 40 - **\$500**
Each ticket purchased will be entered for a chance at all 3 items.

PAYMENT

Make Checks Payable to: Betty Hershberger Fund
 and send payment to **13805 Claridon Troy Road Burton, OH 44021**

Any Questions call Bob 440-834-4221

Drawing to be held April 24th

Call/Text Zak:
(260) 221-2628

**BidBook deadline is
Friday, February 27th.**

Seller: Various Consignors



Michiana Spring Equipment Absolute Auction

March 27th
9 AM EDT

If your equipment sells for \$10,000 or more, you pay NO COMMISSION! Accepting Construction, Excavating, Sawmill and Forestry, Trucks, Trailers and other heavy equipment.

AUCTIONS

Past Michiana Equipment Auction Results:

**Consign
Now!**



2017 Caterpillar D3K2 LGP Dozer
Sold for \$60,000



2019 Komatsu PC138U5LC-11 Excavator
Sold for \$60,000



2022 Bobcat T66 Skid Steer
Sold for \$46,000



2012 Caterpillar D6T LGP Dozer
Sold for \$45,000



2021 Case 21F Wheel Loader
Sold for \$44,000



2021 Massey Ferguson 4710 Tractor
Sold for \$40,000

**Now is the
time to
consign!**

BRIGHT STAR AUCTIONS



AC32100007 (574) 825-0704

10% onsite & 13% online buyer's premium.

Payment: Cash, check, credit card, wire transfer.



2015 Bobcat E45 Excavator
Sold for \$38,500



2019 Case TV380 Skid Steer
Sold for \$36,000

**Bid
Your
Way!**

Live Onsite: 11751 CR 12 Middlebury, IN 46540

Online Bidding: brightstarauctions.com

Phone Bidding: Call (574) 825-0704 to receive a FREE Bright Star Bid Book.

BOOK AUCTION

Thurs, Feb 26th at 3:30pm

PHONE & ONLINE BIDDING

Call for catalog & bidding instructions
or visit bid.brightstarres.com

AUTHORS

- Nancy Drew
- Hardy Boys
- Bill O'Reilly
- Gene Stratton Porter
- James Oliver Curwood
- Grace Livingston Hill
- Laura Ingalls Wilder
- Emerson Hough
- Ralph Connor
- Bill Waterson
- Janette Oke
- Zane Grey
- Louis L'Amour

TYPES OF BOOKS

- Devotionals
- History books
- War books
- Adult fiction
- Little Golden books
- Coffee table books
- Boy's & Girl's books
- Sports Books
- Classics
- True Stories

LOTS OF
OLDER
READERS!

400+ LOTS!

ITEM LOCATION

53894 COUNTY RD 9
Elkhart, IN 46514



ALVIN YODER
(260) 214-9860

Auctioneer, AU11000092

10% buyer's premium. Cash, check, or major credit cards accepted; add'l 3% fee for credit card sales. No credit card payments accepted at pickup. All items can be shipped at buyer's expense.

You Are Invited! BART SELECT BOOK AUCTION

770+ Lots of Selected Books,
Including some Rare, Hard-to-Find!

SATURDAY MARCH 21, 2026 @ 8:00AM

Whether you're looking for that German book to add to your collection, or Amish & Mennonite History, or more, you will not want to miss this auction. These books are consigned from 20 different consignors.
TO REQUEST CATALOG OR PLACE ABSENTEE BIDS CALL: 717-789-7026



TERMS BY: Bart Twp. Fire Co. Sales Committee, PO Box 72, Bart, PA 17503

AUCTIONS

PHONE BID AUCTION

POLY LAWN FURNITURE BUSINESS

Bid Ends Monday, March 23rd • 4:00 pm



Property Location: From Intersection of ST RD 19 & US HWY 6, go north to CR 50, go right approximately 3/4 mile.

Address: 27340 CR 50, Nappanee, IN 46550

THIS IS A TREMENDOUS OPPORTUNITY WITH UNLIMITED POTENTIAL. EARN EXTRA CASH & WORK AT HOME. SELLER IS WILLING TO HELP YOU GET STARTED/TRAINING

BUSINESS SHOP BUNDLE INCLUDES: Tools of the trade, World 50 LP forklift (9,530Hrs), routers, steel cantilever/lumber racks, shelving, tables, workbenches, Dbl bag dust collector, Jet Oscillating edge sander, ridgid band saw, Delta contractor table saw, DeWalt 12" cutoff saw, spindle sander, Northtech NT-555 Over arm router, Jet drill press, aluminum chop saw, patterns, SS fasteners/screw/hardware, some cordless tools, dealer contacts, training if requested.

NOTE: The bid price is for the Shop Bundle only & the Cost of Poly Lumber inventory will be added to the BID PRICE for the final dollar amount as the cost for inventory does fluctuate considerably.

TERMS: 10% down day of sale. Balance due in 30 days, OR pay in full and have immediate possession.

SELLERS: Matthew & Mary Kramer (M&M Poly Furniture)

TO SEE MORE PICTURES VISIT AUCTIONZIP.COM AUCTIONEER ID# 52210

For More Info, Showings & To Place A Bid, Please Call Premiere Auctions At 574-773-0222.



Larry Chupp
574-773-0222

DeWayne Miller
574-538-7800

Anthony Miller
574-354-9295

Bremen Office 574-773-0222 | Now Paris Office 574-354-9295

WINTER GUN AUCTION

**GUNS
sell at
5 pm**

**125+
GUNS**

DENNIS HELMUTH RESIDENCE • 8355 W 700 S, TOPEKA, IN 46571

Wednesday, February 18, 2026 • 4:00 pm

Ducks Unlimited



Long Guns

Remington 1100 Mag, 12 ga, w/rifled barrel
2-Winchester Model 12, 12 ga, 3" full choke (1-solid rib)
Winchester 1894, .30 WCF, good condition, MFG 1921
Savage 99, .250-3000, untapped w/ adj. sights, nice!
Browning A-Bolt, 7mm Mag, wood stock
Winchester 42, 410, 3" chamber, 2nd year production, #11968-Wow!
Weatherby Vanguard, .30-06, Alaskan Edition
Ithaca XL 900, 20 ga, combo, engraved, great condition
Stevens Model 311, Series 8, 5x5, 20 ga
Franchi, 12 ga, over/under, Ducks Unlimited, w/ hard case
Remington Model 311, 12 ga, pump, good condition
Marlin 1895, .45-70 GOVT, lever action
Winchester 1300, 12 ga, 28" VR barrel, new in box!
Weatherby Vanguard, .300 Wby Mag, w/ box
Weatherby Mark XXII Deluxe, .22 auto, w/ original matching scope, nice
FN, .30-06, made in Belgium
Ruger American, .308, w/ Vortex scope
Savage Axis II XP, .308, w/ Bushnell scope
Savage Axis XP, 6.5 Creedmoor, w/ Weaver scope
Anderson Multi-15, AR-style, .350 Legend, w/ Vortex scope
Savage 110, .270 Win, w/ Vortex scope, like new!
Winchester 120 Ranger, 12 ga, pump
Stoeger M3500, 12 ga, semi-auto, waterfowl setup, excellent!
Mosberg 500, 410, pump, very good!
Ruger M77 Mark II, .243, w/ Nikon scope, 90%, nice!
Rossi Circuit Judge, .45 LC / .410, revolving rifle, stainless, NIB
Savage Rascal, .22 LR, youth model, NIB!
Daisy Legacy 2203, .22 LR
Savage 116 Custom, .243
Iver Johnson, 22 Super-Shot, sealed 8, revolving long rifle
AR-15, .224 Valkyrie, w/ Vortex Diamondback scope
Ithaca Model 37, 12 ga
Winchester 870 Wingmaster, 12 ga
Winchester SX3, 20 ga, like new!
Mosberg 500 Combo, field/deer, 12 ga
Savage 93, .22 Mag, NIB!
Marlin 60, .22 LR, NIB!
Remington 597 SS, .22 LR, NIB!
Remington 11-87 Sportsman, 20 ga
Remington 7400, .30-06, semi-auto, w/ scope and sling
Mosberg 352KC, .22 LR, w/ scope
Anderson Manufacturing AM-15, 5.56 / .223
Winchester 1200, 12 ga, "early model"
Benelli Super Black Eagle I, 12 ga, 3 1/2"; upgraded case!
Beretta 1200, 12 ga, w/ Benelli inertia system
Remington 1100, 20 ga, 3" Magnam
Franchi 530, 12 ga, HD semi-auto
Winchester 77, .22 LR, semi-auto
Winchester 64A, .22 LR, bolt action



Winchester



Remington

Ruger

Henry Fireman's Tribute

Marlin 60, .22 LR, semi-auto, heavy Bbl
Savage 64, .22 LR
Benelli Super Nova, 12 ga, extra chokes
Christensen Arms, .308 Win, Model 25, NIB!
Mosberg Patriot 400 Legend, walnut, NIB!
Beretta A300 Ultima, 12 ga, semi-auto, NIB!
Bear Creek Arsenal AR-15, .300 Blackout
Saiga AK-47, .223 Rem, w/ scope and clip
Winchester SX4, 12 ga, camo, extended mag tube
H&R Handi-Rifle, .444 Marlin, w/ scope
Savage A17, .17 HMR, semi-auto, new!
Mosberg 817, .17 HMR, w/ BSA scope, nice!
Hi-Point 995, 9mm, semi-auto rifle
CVA Scout, .350 Legend, new!
Rock Island Armory AK-47, .22 LR, new!
Rock Island Armory TM-A-18, .22, new!
Franchi Momentum, 6.5 Creedmoor, new!
2-Winchester 94, .32 Spl, lever-action
Winchester 94, .30 WCF, lever-action
Ruger Archangel, .22, semi-auto, w/ Aim scope and lighted reticle
Browning BL-22, lever-action, .22, w/ box
Remington 552 Speedmaster, .22, semi-auto
Savage Model 99, .250-3000, w/ original Weaver K2.5 scope
Mosberg International 715T, .22 semi-auto NIB!
Marlin 81-DL, .22 bolt-action with original scope
Ithaca M-49 lever-action .22
JC Higgins Mod. 1011 16 ga, single-shot
H&R Trooper 58, .410 single shot
Ithaca Single 66 20 ga.
Rossi .22 LR-.410 ga. combo gun
GForce Arms .350 Legend 20" 8BL single shot NIB!
ATI Alpha Maxx RIA 5.56/.223 M10K stock, 60 RND
Escort/Hatson .410 pump-action Bullpup NIB!
Escort/Hatson .410 semi-auto Bullpup NIB!

Commemoratives & Collectibles

Winchester 94 .30-30 Sturgis, SD Black Hills Motor Classic 50th Anniversary 1990, gold chromed, inlaid, and engraved #38 of 250
Winchester 94 .30-30 Daytona Beach Bike Week 50th Anniversary 1991, gold chromed, inlaid and engraved #38 of 250
Ruger New Model Super Blackhawk .44 Mag. Sturgis, SD Black Hills Motor Classic, 51st Anniversary 1991, gold chrome, engraved
Winchester 94 .30-30 Buffalo Bill Commemorative NIB!
Winchester 94 .30-30 USA Bicentennial Commemorative 1776-1976 NIB!
Winchester 94 .30-30 NRA Centennial 1871-1971 Commemorative Musket NIB!

Winchester 94 .30-30 NRA Centennial 1871-1971 Commemorative Rifle NIB!
Winchester 94 .30-30 Illinois Sesquicentennial Commemorative
Winchester 9422 .22 LR Boy Scouts of America 1910-1985 75th Anniversary Commemorative NIB!
Rossi Rio Bravo .22 LR Lever-Action Theodore Roosevelt Rough Riders Commemorative 1 of 500 NIB!
Ruger 10/22 75th Anniversary .22 LR Natural Maple NIB!
Ruger 4125 Over/Under 12 ga. Original boxes, papers, etc. Collector quality!
Winchester 42 410 Pump 2nd year production serial #11968
Franchi Luigi Over/Under 12 ga. Ducks Unlimited, gold inlay, engraved, Elk River custom case, very nice!
Remington Model 4 .22 LR Rolling Block, very early

Henry Rifles

Henry H004FM .22 Golden Boy Fireman's Tribute, Engraved w/Gold Inlay, NIB!
Henry Silver Eagle .17 HMR, NIB!
Henry Golden Eagle .22 LR, NIB!
Henry American Eagle .22LR NIB!
Henry Silver Eagle H004SE2 .22 LR 2nd Edition
Henry Golden Boy .22 LR NIB!
Henry Silver Eagle .22 LR

Remington 700's

Remington 700 BDL .25-06 90% cond. Nice!
Remington 700 BDL .300 Win. Mag. 99%, with original green box
Remington 700 BDL .17 Rem. Very nice!
Remington 700 BDL .270 Win. 80% + scope
Remington 700 BDL 6mm Varmint Special 90%
Remington 700 BDL .270 Win. 80% + scope
Remington 700 BDL .25-06 70% +
Remington 700 BDL .300 Win. Mag. scope, nice!
Remington 700 BDL .270 Win. 70% +
Remington 700 .243 Win. 90%
Remington 700 .300 Win. Mag. bull barrel
Remington 700 .243 scope, sling, good cond.

Hand Guns

Colt Government Model 9mm "Competition Series", NIB!
Remington XP-100R, .35 Rem, bolt-action 15" barrel with Burns scope!
Bond Arms Snake Slayer, .45/.410 pistol
CVA Scout, .350 Legend, new!, 14" barrel!
Heritage Rough Rider, .22 LR/.22 Mag revolver
Para 14-45 Limited, .45 ACP pistol, SS, 6 mags, NIB!
Glock 36, .45 Auto, 5 mags, like new!
Glock 21, .45 Auto, 5 mags, NIB!

Glock 44, .22 LR, 4 mags, NIB!
Sig Sauer P229, 9mm, Legion Series pistol, NIB!
CZ 75 Compact, 9mm, 2 mags, like new in box!
Smith & Wesson M&P 45, .45 Auto, 4 mags
Springfield Armory 1911-A1 9mm Range Officer Series NIB!
Sig Sauer 1911, .22 LR, with 3 mags
Smith & Wesson 629 Classic, .44 Mag, SS revolver
H&R 1889, .22 Short revolver
Tara 9mm Perfection, 2 mags, case, A+ cond
Smith & Wesson 915, 9mm pistol, A+ cond
Smith & Wesson 422, .22 LR semi-auto pistol
Zastava 70, .32 ACP semi-auto, holster, 2 mags
Ruger Single Six .22 LR, Early Collector

Military

Japanese Arisaka Type 38, 6.5 x 50mm, matching serials
Russian Soviet Mosin Nagant, 1937, 7.62, sporterized
Russian Soviet Mosin Nagant, 1936 R, 7.62, matching serials
Winchester U.S. Model 1917, .30-06
Lee Enfield WWII Jungle Carbine, .303 British
Mauser, Spanish purchase, 8mm Mauser
Soviet Nagant M44, 7.62 x 54
Several other Spanish or Argentine Mausers
Come check them out, have not had time to do research on all of them yet

Bows & Crossbows

Ravin R10 Sniper Package - 410 FPS, Complete Package - Ready to Hunt! (New!)
Centerpoint AT400 Package, includes arrows, quiver, etc.
Killer Instinct Ripper 415, 12 arrows, broadheads, SKB hardcase
Bowtech Fanatic Compound, Adjustable draw length - up to 75# draw
Barnett Vortex Hunter Youth Bow, Up to 45# draw
Two bows set up for bow fishing

Air Rifles

Beeman Longhorn Break Barrel, .177 cal - NIB!
Marksmen Big Bear Break Barrel, .177 cal - NIB!

Optics, Supplies & Misc.

New Vortex Scope, Hawke Scope, New Vortex Diamondback Binoculars, New Vortex Crossfire Binoculars, Compound Bow Hardcase, Backpacks, Gun Cases, Shooting Supplies, Food Plot Seeds, Minerals, etc.

Lots of Ammo

Auction Conducted By:

**Memory Lane
Auction Service**
Topeka, Indiana

Vernon F. Miller
AUI1080088
260-993-0915

Calvin Miller
AUI1220052
260-993-0941

Assisted by Detweiler Auctions

All guns pictured by Feb. 5, 2026 on: [AuctionZip.com](https://www.auctionzip.com) ID: 48623 | [GoToAuction](https://www.gotoauction.com) ID: 10061

Not responsible for accidents or items after sold. Any arrangements made day of auction take precedence over any and all printed material. **Terms:** Cash or good check with proper ID. No Credit Card. Indiana Sales Tax of 7% will be charged on all purchases unless proper ST-105 is on file. **All bidders who purchase a firearm will be required to complete a background check.** Checks will be done on-site evening of auction. Buyers receive possession upon clearance of background check. Buyers are responsible to pay a \$25 fee per gun for background check.

For Catalog
Call or write:
260-593-0941
Memory Lane Auctions
7568 E. 1200 N-57
Wokotville, IN 46795

WINTER BOOK AUCTION

500+ LOTS

DENNIS HELMUTH RESIDENCE • 8355 W. 700 S, TOPEKA, IN 46571

February 18, 2026 • 4:00 pm



COMPLETE SETS & SERIES

The Storm Testament by Lee Nelson
A Child Called "It" by Dave Pelzer
All Creatures Great and Small by James Herriot
Walker (9 books)
Hatchet Series by Gary Paulsen
The Hardy Boys 1-60 by Franklin W. Dixon
The Killing Series by Bill O'Reilly
Legends & Lies Series by Bill O'Reilly
Confronting Evil by Bill O'Reilly
Thornton W. Burgess Canadian Edition Set -- 20 books (Wow!)
Curious George Classic Collection HC
Rebels & Yankees Civil War Set
Walt Disney Fun-to-Learn Library
My Book House Set (Great for Kids)
The Complete Calvin & Hobbes in 3 Volumes
Angel of Mercy Series by Al Lacy
Abram's Daughters by Beverly Lewis
Brides of Webster County by Wanda Brunstetter
Daughters of Lancaster County by Wanda Brunstetter
Return to Red River by Lauraine Snelling
Complete Set of 21 by Lewis B. Miller
Little House Set by Laura Ingalls Wilder
The Old West Set by Time Life -- 23 books
The Civil War Set by Time Life -- 28 books
Childcraft Set
Children's Hour Set 1-16

ANTIQUES & COLLECTIBLES

Horatio Alger Jr. Originals (1880s-1920s)
James Oliver Curwood (1910s-1930s)
Thornton W. Burgess Complete Canadian Edition Set -- Wow!
Thornton W. Burgess Pink Cover (1940s)
James Herriot (Hardcover Set)
Gene Stratton-Porter Memorial Edition Set of 8

The Storm Testament Set of 10
Uncle Tom's Cabin by Harriet Beecher Stowe (Very Early)
The Shepherd of the Hills (1907)
Hound-Dog Man by Fred Gipson (1949 w/DJ)
Lone Ranger Books (4) by Fran Striker (1930s)
Mary J. Holmes Novels (Early 1900s)
Grace Livingston Hill Novels (1920s-1950s)
Zane Grey (Walter J. Black Editions) -- 1970s
Harold Bell Wright Books (1910s-1920s)
19 Hardy Boys Originals w/ Dust Jackets (1920s-1930s) -- Nice!
Basic Readers
Hardcover Sacketts Series by Louis D. L'Amour + Many More

BIBLE RELATED

Greatest Story Ever Told by Fulton Oursler (1950)
Joseph and His Brothers by Thomas Mann (The Complete Works, 1966)
The Robe & The Big Fisherman by Lloyd C. Douglas (Illustrated Book Club Editions w/ DJ, 1950s - Awesome!)
Story of Jesus by Canon Farrar (1890)
Life of Christ by Canon Farrar (1849)
The Nazarene: Moses, the Apostle, the Prophet, etc. by Sholem Asch (1930s)
Joseph in Egypt (2 book slipcase) by Thomas Mann
Adam's Map of History (Timeline from Creation to 1871)
Life Application New Testament Commentary
Das Neue Testament und Psalmen (Large Print)
History of the Berneese Baptists
Menno Simons Complete Works
Ben Hur by Lew Wallace (1908)

TRUE STORIES

Unbroken
The Forgotten 500

Over the Edge
Ice Bound
Bear Attacks
The Mad Trapper of Rat River (Canada's Biggest Manhunt)
Nickel Mines
True Tales of the Great Lakes
Walk in My Combat Boots
Last Man Down
Stolen into Slavery
A Cop's Life
The Job: True Story of a New York City Cop
A Higher Call (World War II Pilot)
Inferno (World War II Gunner)
The Lattoot at Auschwitz and its Sequel
No Easy Day
American Sniper
Lone Survivor
Black Hawk Down
Navy SEALs Books
Catch Me If You Can -- Frank Abagnale Story
Barefoot Bandit: Colton Harris-Moore, American Outlaw
Ponzi: The King of Financial Cons
Abandoned Prayers: The Story of Little Boy Blue
Bonnie & Clyde: The True Untold Story
Lots of Game Warden Stories
Several Books on Bin Laden's Capture + Many, Many More

AUTHORS

Lee Nelson
Louis L'Amour
Zane Grey
Harold Bell Wright
Gene Stratton-Porter
Walter Farley
Horatio Alger Jr.
Thornton W. Burgess
James Herriot

Laura Hillenbrand
Chris Fabry
Kendrick Bros.
Sholem Asch
Thomas Mann
Fulton Oursler
Bill O'Reilly
Patrick McManus
Laura Ingalls Wilder
Lloyd C. Douglas
Franklin W. Dixon
Carolyn Keene
Max Lucado
James Patterson
John Gribham
Mark Twain
Dr. Seuss
Mike Lupica
Matt Christopher
Wilson Rawls
Edgar Rice Burroughs
James Oliver Curwood
Andy Andrews
Terri Farley
Francine Rivers
Cindy Woodsmall
Terri Blackstock
Janette Oke
Beverly Lewis

COMICS

Calvin & Hobbes
Zits
Baby Blues
Garfield
400+ Archie Comics
The Fair Side Gallery
Popeye
Dennis the Menace
Family Circus
Peanuts and More

TITLES

Warroom
Fading the Giants
Flywheel
Overcomer
Courageous
The Forge
Lifemark
Seabiscuit
Unbroken
No Easy Day
Lone Survivor
American Sniper
Old Yeller
Savage Sam
I Starvied...
Tom Sawyer
Huckleberry Finn
Gone with the Wind
Heaven is for Real

CHILDREN'S BOOKS

Dr. Seuss
Curious George
Berenstain Bears
Clifford
Biscuit
Amelia Bedelia
Encyclopedia Brown
Pony Pals
Saddle Club
Puppy Patrol
Boxcar Children
Winnie the Pooh
Max Lucado Kids' Books
Great Illustrated Classics
Franklin the Turtle
Little Golden Books

Auction Conducted By:
Memory Lane
Auction Service
Topeka, Indiana

Vernon F. Miller
AU10800088
260-593-0015

Calvin Miller
AU11200052
260-593-0941

Assisted by Detweiler Auctions

Not Responsible for Accidents or Items After Sold. Any announcement made day of auction takes precedence over printed material. Terms: Cash or Good Check with Proper ID. Indiana Sales Tax of 7% will be charged on all purchases unless proper ST-105 is on file.

AUCTIONS

Location:

6975 S. 1100 W.

Millersburg, IN 46543

PUBLIC AUCTION

Saturday, March 14, 2026 • 9:00 am



Dewayne & Edna Yoder

FARM EQUIPMENT

TR 165 Gehl skid loader, attachment: 3 buckets 60", 72", 74"R.C. 7 x 16 x 6 enclosed trailer, 2017
Forks 54"

Bale spear

Deck mower 72"

Driveway grader

Hay wagon

23 kw diesel Gen-set

15 ton feed bin

7 ton feed bin

40' tub heaters (2) NG

Brooder I-40 heaters NG & more

Duck barn equipment

Round bale hay feeder

Farmer gates

Fence posts

Barn doors on rollers

Manure forks

LIVESTOCK

2 yr old pony/Standard bread

2 yr old Morgan (reg)

BUGGIES, HARNESS, EVENERS

36" Gravely lawn mower

30" Toro lawn mower

21" Lawn Boy mower and more

12' Alum. boat w/trailer (has title)

4.5 hp Mercury outboard motor

12V trolling motor

Patio wicker set

(2) Patio wood rockers

Desota 3-wheel bike (like new)

MILKING EQUIPMENT

Gentalizer & milking chair

Head gate (calf)

Old milk can cart

SHOP TOOLS & EQUIPMENT

Table saw

Electric stick welder

Electric well pump (10 gpm)

Potato plow

(3) Wheel barrows & parts

Reddy Heater 15000 btu

Pallet racking (3 sets)

(2) 5 hp Honda motors

3000w Honda generator

7000w Honda generator

18 gal Shop-Vac

5/8 SS cable (3000 ft roll)

Handyman jack

Honda trash pump

HOUSEHOLD, FURNITURE, MISC.

(2) Bedroom sets

Book shelf 36" x 60"

40 cu refrigerator

Blue couch & loveseat

Blue round rugs

Round table with glass top 38"

(6) wood kitchen chairs

Office chairs

Table 32" x 53"

Gas floor lamp

Kerosene heater

Campstove

White plastic chairs

Laundry cart

Patio set (love seat & chairs)

Plant stands

(2) Copiers

Life time cookware set

Cedar chest

Quilts, blankets (lots of bedding)

(2) Coleman irons

Ice skates

Ping pong table, paddles, net

Bikes

Basketball rims

Balls, bats & gloves

ANTIQUES, PRIMITIVES, COLLECTIBLES

Chicken crate

Barn pulleys

Drills

Food Available by Heartland School

Devon & Lorene Yoder

J.D. 1240 4-row plateless corn planter

4-row I & J cultivator

10' Miller weeder (almost new)

14' Rex forage wagon

IH 510 18 grain drill

Oliver 2 btm plow

NH 488 haybine (one owner)

40' Kewanee Elevator

12' Cultipacker

12' J.D. Spring tooth harrow

15' J.D. Spike tooth harrow

J.D. hydra push manure spreader

IH Wheel disk

Power cart 35 horse

M.M. Corn Sheller

21 x 26 wood silo doors

8" Silo distributor

26 x 40 round top building (frame only)

Skid attachment

8' Sweeper

Tire scraper

4' Trencher

3 & 4 yr black buggy pony mares, full sisters, good broke

Auction Conducted By:

*Memory Lane***Auction Service**

Topeka, Indiana

Vernon F. Miller

AU10800088

260-593-0015

Calvin Miller

AU11200052

260-593-0941

30TH ANNUAL

3 Big Days

Southern Indiana

Bring a Friend
Approx 10 Rings
selling

Spring - Horse, Carriage, Antique & Machinery Auction

Don't Miss this
Auction Something
for everybody

March 4, 5 & 6 2026

Dinky's Auction Center - Montgomery, IN
GPS Address: 9073 E 550 N, Odon, IN 47562



Spring Wagon



Covered wagon w/brakes



Haflinger size Wagon



Wagon w/ 4 wheel brakes



Competition Buggy



2 seated Surrey w/brakes



Cocks Sell Wednesday



Deering Ideal One Horse Mower



Cider Press



DSP



SSP



DSP



SSP



SST



10 Gal Visible with a White Crown Globe



SSP



SST



Wolfhead on stand DST "N.O.S."



DST



DSP



Signs Sell Wednesday

Schedule of Auction

Wednesday, March 4

- 8AM Antiques & other small items
- 8 AM Large Primitive Furniture Auction
- 11AM Wagon Wheels, Wooden Wheel Wagons & Steel wheels

Thursday, March 5

- 8AM Horse-drawn Machinery, Tack, Lots of Antiques, etc
- 10AM Harness & Washing Machines
- 5PM Standardbreds (Accepting 130 Head of Driving Horses)

Friday March 6

- 9AM Draft Horses & Ponies

Last yrs Auction had approx. 300 Carriages & Sleighs
Over 5000 Antique Items selling in 2 days



Patial Listing

Gravity wagons, Elevators, Wheat drills, Several nice manure spreaders, wagon gears, Several small tractors & skid loader, lots of new & used skid loader attachments, Several Diesel Power Units, welders, Air Compressors, & lots of Misc



Pioneer Wagon



New Pony Cruiser



New Mini Size



Mag Wheel Cart

For more info or to consign:

Paul Raber (812)486-8160 - 7226 E 300 N, Montgomery, IN 47558
Eli G Knepp (812)259-4678

SOUTHERN INDIANA AUCTION CO. Montgomery, Indiana - AC30400005

AUCTIONS

FINE ART & MCM SATURDAY AUCTION!

VERY UNIQUE AUCTION!



Saturday, February 28th - 10:00am EST
2909 Peddlers Village Rd., Goshen, IN 46526



Bid live in person or online at www.liveauctioneers.com or www.invaluable.com!

MCM - Art Deco - Glassware - Musical Instruments - Knives - Sculptures

Mid-Century Modern:

Egyptian Thebes Stool; Coffee Table; Teakwood Sculpture; Variety of Lamps

Art Deco:

Cubist Style Unity Sculpture; Curtis Jere; Marshall Studios; Zhou Brothers Sculpture; Murano Lamp; Shlomi Haziza Sculpture; Copper and Brass Pieces

Glassware:

Millefiori; Murano; Mats Jonasson; Viking Epic Drape Vases; Joe Rice Paperweights; Elwood, IN Paperweights; Monte Dunlavy Paperweights & more; Chrisco Pottery; Per Lutken Vase; Kosta Boda

Musical Instruments, Electronics, Knives, & Misc:

Revox Electronics; Saxophones; Guitars; Banjos; Flute; 20+ Knives including: Korea World War II; Case; Pocketknives; Buck; Blackjack; Military & more; Singer; Featherweight Jr. Sewing Machine; Antique Mantle Clock; Zippo Lighter

50+ Figurines:

25+ Lladro; Cascades; Royal Dux; Royal Copen Hagen; NAO; Staffordshire; Rosenthal

90+ Unique Natural Stone Sculptures:

Crystal Designs; Birds; Frogs; Reptiles; Skulls; Obelisks; Spheres; & Many More Animals and Designs

Terms: Join us LIVE AND ONLINE starting at 10am EST for a very unique auction that you don't want to miss! There is a 10% Onsite Buyer's Premium and a 20% Online Buyer's Premium added to final bid price, in addition to Sales Tax.



For more pictures visit our Facebook page, and AuctionZip.com - Auctioneer ID: 31685. For any questions, contact Ervin Yoder

Peddlers Auction

574-875-3233

- Weekly Consignment Auctions
- Estate Buyouts
- Personal Property Auctions

Auction Contact:
 Ervin Yoder 574-407-0924



- Design a custom portable building or buy from our lot!
- 6-year warranty
 - Free delivery within 75 miles

L&S Movers

- We provide a stress-free moving day!
- From the old house to the new
 - From upstairs to downstairs
 - Simply from one room to another

Owners: Marlin Yoder 574-536-1783
 Al Lehman

PEDDLERS SURPRISE SATURDAY AUCTION!

FREE Coffee & Donuts until 9:30am or gone!

Saturday, February 21st - 9:00am
2909 Peddlers Village Rd., Goshen, IN 46526

A MUST-SEE AUCTION!

48' Semi Trailer Packed Full of LOTS of Surprises to sell!

75+ Knives - Trains - Antiques - 100+ Coins - Furniture - 100+ Toys - Tools

Coins:

75 Morgan Dollars 1878-1921; 20+ Peace Dollars 1922-1935; 15+ Peace Dollars; (15) 1oz Silver Rounds; (5) 1oz Silver Bars; Proof Sets

Knives:

Buck; Smith & Wesson; Rough Rider; Old Timers; Gerber; Kershaw; Frost; Bear & Son; Browning; Coleman; & Many More!

Toys:

John Deere Pedal Tractor; Precision Series; Case IH; GI Joe; Trains; Hot Wheels

Furniture:

Large Pantry Cabinet; Bedroom Sets; Dining Room Sets; Living Room Sets

Antiques:

Butter Churns; Glass Jars; Signs; Radios; Railroad Lanterns



*NEW 16' Flatbed Trailer



Primitives



Knives



Large Collection of Coins



Toys

Join us LIVE starting at 9am for an awesome auction that you don't want to miss!
 Sales Tax and 10% Buyer's Premium added to final bid price.

For the knife and coin catalog or to view more pictures, visit our Facebook page, and AuctionZip.com - Auctioneer ID: 31685. For any questions, contact Ervin Yoder.

Peddlers Auction
 574-875-3233

- Weekly Consignment Auctions
 - Estate Buyouts
 - Personal Property Auctions
- Auction Contact:
 Ervin Yoder 574-407-0924



- Design a custom portable building or buy from our lot!
 -6-year warranty
 -Free delivery within 75 miles

L & S Movers

- We provide a stress-free moving day!
- From the old house to the new
 - From upstairs to downstairs
 - Simply from one room to another
- Owners: Marlin Yoder 574-536-1783
 Al Lehman



RABER FARM AUCTION



LOCATION: 11304 S. Woodruff Rd. Blanchard MI 49310

DIRECTIONS: From Winn. MI take Blanchard Rd. West 3 mi. to Woodruff Rd. South 3 ¼ mile to auction or from Edmore go East ½ mil. On M 46 to Deja Rd. North 4 ½ mi. to Remick Rd. East 2 miles to Woodruff Rd.

THURSDAY, FEB. 19, 2026 @ 9:30 AM

50 SHEEP – 2 GOATS: 38 Polypay cross ewes due to start lambing by March 1.... Consists of mostly 2-3 yr. olds- some up to 5 yrs. old, (1) 3 yr. old & (1) 2 yr. old Poly pay rams both proven, 11 yearling ewe lambs due to start lambing in May. NOTE: A healthy foot rot free flock, 1 Alpine cross doe due in April, 1 yearling Alpine cross doe.

8 JERSEYS: 1 Shortbred Jersey family cow, 16 mo. old Jersey heifer, approx. 500 lb. Jersey steer, 4 Jersey steers approx. 250 lb., 1 Jersey heifer calf.

30 PCS. FARM EQUIPMENT: 4 cyl. John Deere diesel w/ Rockford clutch on gear, JD. 14 T. baler, NH. Super 66 baler for parts, Mc. D. #9 high gear mower, JD. 4-bar hay rake, 2 kicker tedders- 1 for parts, NI. Hay wagon w/ racks & sides, 2 Oliver #2 hay loaders- 1 for parts, JD. Van Brunt 13-hole steel box grain drill, Mc. D. 7' grain binder, Mc D. 2 row corn planter w/ plates, Mc. D. corn binder & bundle carrier, Gehl silo filler & pipes, Yoder field sprayer, 24' hay & grain elevator, JD. corn sheller, hammer mill, NI. #10 manure spreader, JD. E manure spreader for parts, lime spreader attachment, cone fertilizer spreader on mower gear, TILLING EQUIP.... Hostetler left hand 16" plow, 7' disk, 7' & 10' spring tooth harrows, like new Miller 2-row cultivator, Mc. D. 1-row cultivator, 1-horse cultivator w/ seat.

FARM MISC.: buzz saw on wheels, steer feeder, 4-ton steer stuffer, 8 ton poly feed bin, sheep feeders, 55 gal. SS. milk mixer, 90 gal. SS. water kettle, approx. 90 double bucket holders, approx. 150 calf buckets, litter carrier w/ 90' track, rolling cultivator shields, small sap pan, sap buckets, platform scale, fuel tank on stand, rabbit hutches, 2 & 3 & 4 horse eveners, 2 goodie wagons of small farm misc.

BUGGY- HARNESES: open buggy, 2 pony carts, road cart, completes set draft harness, pony harness, misc. harness, assorted collars, eveners – misc.

SHOP TOOLS: Delta table saw, 10' Craftsman table saw, Powermatic 12" planer, Rockwell jointer, metal cutting band saw, assorted lineshafts & pulleys.

HOUSEHOLDS: older New Decade Ashland stove, smaller summer stove, Formica top drop leaf kitchen table w/ 7 leaves, kitchen chairs, dressers, recliner, Singer sewing machine heads, White sewing mach. Head, 3 gal. wooden butter churn, type writer, lots of misc. not listed. Porch sale on site w/ clothing & misc. etc.

TERMS: Cash or check w/ ID. **SALE ORDER:** Starting @ 9:30 AM w/ wagon loads of smalls & households-farm equip. approx. noon, finishing with livestock.

LUNCH & BAKE SALE: By Amish Ladies.

AUCTIONEERS:

ANDY RABER AUCTIONS LLC
5165 TR 118 BALTIC OH 43804
OFFICE: 330-893-2604
CELL: 330-473-3994

ASSISTING AUCTIONEER:

DAN WEAVER
330-231-8865



330-893-2604

OWNERS:

NELSON & KATIE RABER
11304 S. WOODRUFF RD.
BLANCHARD, MI 49310

38th ANNUAL

AIR WORKS

CONSIGNMENT AUCTION LTD.



AUCTION & SHOWCASE



Thursday, Feb. 19th 2026 at 8:30 AM
 Friday, Feb. 20th 2026 at 8:30 AM
 Saturday, Feb. 21st 2026 at 8:30 AM

All Auction Inquiries: 330-845-8485
AirWorksAuction.com

Mt. Hope Auction Grounds, Mt. Hope OH | Auction & Showcase Location (GPS): 8076 SR 241, Millersburg, OH 44654

Mt. Hope

SHOWCASE

Mt. Hope Event Center

Thursday February 19, 8AM - 6PM
 Friday February 20, 8AM - 7PM
 Saturday February 21, 8AM - 12 NOON

For information, call 330.845.8485
 MtHopeShowcase.com

2026

CURRENT 2026 EQUIPMENT SALE ORDER

- Sawmill & Pallet Equipment- Thursday, Feb 19
- ★ Metalworking Equipment- Thursday, Feb 19 ★
- Power Units & Compressors- Thursday, Feb 19
- Heavy Equip./Rolling Stock- Fri. Feb 20 - Sat., Feb 21
- Woodworking Equipment- Friday, Feb 20
- Heavy Equipment- Saturday, Feb 21

Also selling Smalls and Industrial Items all 3 days

Consignment Unloading Schedule:

Heavy Equip. & Attachments (On wheels or tracks), Sawmill Equipment, Power Units & Gensets:
 February 4th - 6th 8:00AM - 4:00PM, February 9th 8:00AM - 8:00PM, February 10th - 13th 8:00AM - 4:00PM.
 All other equipment including Woodworking, Metalworking, and Industrial Items:
 February 16th 8:00AM - 8:00PM- 17th & 18th 8:00AM - 4:00PM or until lot is full.

AUCTIONS



15780 Body Road
Danville, OH 43014

Goat Pairs & Dairy Goats

Production & Babies

AUCTION

FEBRUARY 21TH

already consigned

100% Black Dapple Doe, 3 yr old with Kid on the side

9 month old Dapple Boar Billy, very stocky build

March 7 Featuring Antiques & Collectibles + Coins
 March 21 Annual Spring Consignment & Machinery Auction
 March 27 Check in for Special Breeder Bird Sale 4pm
 March 28 Special Fancy Bird, Mini & Unusual Animal Auction

Call Dennis Hershberger 740-485-9397

Hay Auction Saturdays 9:30am
Pick up a 2026 schedule in our office.

SPECIAL BREEDER ADDITION AUCTION

MARCH 28TH

Mini/Unusual Animals & Fancy Bird

Accepting consignment of
 mini horses, donkey, cows, trophy horned sheep, goats & fancy birds.
 Hay will sell at 9:30
 Fancy Birds 10:00
 Goats at 10:30
 Mini Animals 12:00



Poultry cages should be able to be see through. Animals & Birds can be dropped in Friday the 27th at 4:00 pm prior to auction date but must have water & feed in cages. No cardboard boxes.



Birds can be checked in Friday the 27th at 4:00 pm

Auctioneers:
 Dennis Hershberger 740-485-9397
 John Miller 740-485-6001
 Ivan Mast 330-474-2820
 Dan Otto 765-437-8694
 Arlen Yoder



15780 Body Road
Danville, OH 43014

PUBLIC AUCTION

LOCATED: 3 miles south of LaGrange, IN. on St. Rd. 9 to 300 S, east 2 miles to auction.

ADDRESS: 3600 E 300 S, LaGrange, IN 46761

SATURDAY, MARCH 14, 2026

Beginning
at 9:00 am

• FARM MACHINERY •

560 Farmall wide front gas tractor on air; 22" McCormick threshing machine, used in 2025; New Idea corn husker shredder; Gehl B-40 silage cutter; Papec K silage cutter with pipes; ground driven corn binder; Millers 2-row cultivator with shields; McCormick single row cultivator; 2-row John Deere corn planter for parts; Pioneer right hand plow; (2) #9 International 6' hay mowers; (1) #7 International 6' hay mower; New Idea 4-bar hay rake; 2-rack wagons with box & uprights on steel; 6' McCormick grain binder; 9-hole McCormick drill; New Idea 10A manure spreader; 10' lime spreader; forecarts on steel; box wagon with steel wheels; (2) 5-bolt steel wheels; 8' John Deere disc; rotary hoe; 6' drag, threshing machine cyclone; 21" stationary Gehl grinder with bagger;

• BUGGIES • HARNESES •

Queen buggy with slide ups; (2) single buggies with slide ups; double buggy with curtains; spring wagon; buggy trailer; 2-wheel cart; small pony cart; pony sled; buggy wheels and springs; (2) sets of draft harness; pony harness; harness parts; collars; saddle; wood & steel eveners; wood & steel neck yokes;

• MILKING • FARM RELATED •

Milker vacuum with tank; (3) 5 gallon milker buckets complete with pulsators; S.S. milk can; double S.S. wash tub; S.S. milk strainer; hobbles; kant kicks; gentlizer; old cow stanchions; milking stools; corner pig feeders; (2) cement hog troughs; small round feeders; galvanized water tanks; chicken crates; rollaway chicken nest; old used roof metal different lengths; used steel posts; (30) 4" x 1" x 7" creosote posts; 1" x 6" creosote fence boards; (2) 12" x 20' heavy duty plastic culverts; (7) 4' x 6' rubber mats; (180) used 8" cement blocks; (2) box stall fronts with sliding doors; (1) divider; scrap iron; motors for parts; old 12 volt batteries; pop cans and aluminum scrap; 1500 gallon heavy duty supply tank; 40 gallon S.S. open tank; 2-compartment quail cage; steel parts for shoeing stocks;

• 10' x 16' Insulated Chicken Coop •

• LAWN & GARDEN • SHOP •

300 amp D.C. stationary welders with cables; welding helmet 16' wooden extension ladder; forks shovels; hoes; pick; wood turning lathe with knives; 10" table saw with Honda motor; post hole digger; hedge trimmers; skidding tongs; log skidding Lizard; groundhog tiller with Honda motor; Onen generator; powerhorse generator as is; hand crank forge; hand crank corn sheller; (2) flat belts; buzz saw; buzz saw blade; Fairbank platform scales; wall mount drill press; (3) whirly bird vents; 48" Hustler lawn mower, 30" power mower; (4) 21" power mowers; reel mowers; windmill pump jack; bikes; sythe; 2-man cross cut saw; small play wagon; old windows & doors; bushel crate; misc. woven wire & chainlink fence; 1-horse cultivator; push cultivator; camping tent; life jackets;

• BUTCHERING • APPLIANCES •

No. 22 meat grinder on stand with S.S. blades, beef hanger, block & tackle; Kero tank heater; 3-burner perfection oil stove; wood burning water heater;

Hitzer wood stove; LP gas stove; old Dutchwest wood stove; electric chest deep freeze; 18 cu. ft. fridge works, sells as is; (2) patio heaters; kerosene heater; propane heater heads;

• 12' Washhouse Worktable With Double Sink & 2 Upper Sections •

• 1200 Sq. Ft. Used Laminated Flooring •

• Used Bamboo 3/4" x 4" Glueless Flooring •

• HOUSEHOLD • MISC. •

Antique granite top table; small Formica top table; cast iron white enamel finish farm sink; granite bathtub; round cast iron stove pipe register patented 1897; (4) complete beds, (2) queen, (2) full; twin size bunk bed, no mattress; twin bed; toddler bed; 6 yr. crib; play pen/crib combo; large hide-a-bed couch; (2) loveseats; upholstered toy box couch; assorted older chairs; coffee table; night stands; wardrobe; large cabinet with shelves; (3) chest of drawers; bureau in good condition; (2) 4-drawer dressers without mirrors; (2) dressers with mirrors; wardrobe; assorted large mirrors including (1) antique; roll-away battery light stand; (2) antique sewing machines with cabinets; old sewing machine heads & accessories; propane wall heater, lightly used; old camp stove; potty chair; 18" x 53" S.S. dry sink; heavy duty cast iron sink bowl; good bathtub & shower; galvanized bath tub; (2) square galvanized tubs; assorted kerosene lanterns; gas lanterns; gas lights; kerosene lamps & heads; coppa pleater; wooden 6-shelf pie carrier box; antique tin pie carrier; aluminum 7 qt. canner; old pressure cooker; regular & 2 qt. canning jars; assorted canning jars & bottles, good or new caps; assorted jelly jars; old 4 qt. tin lard cans; popcorn tins; granite mixing bowls & roasters; salad masterset; America's Best cookware set including 12 qt. kettle; cast iron pans; noodle maker; hand cranked dough mixer; S.S. 1 gallon ice cream freezer can; Immergood tub hand cranked 6 qt. ice cream freezer; 30 cup aluminum coffee percolator; apple peeler; thermoses; water jugs; lunch pails; assorted tupperware; lots of misc. kitchenware; vases; (86) 9" tin pie pans; (44) small bread tins; foot pedal wringer mop bucket; qt. & pt. fruit boxes; wooden pulleys with hooks; old suitcases; cornhole frame sets; ping-pong table; paddles; balls & net; wooden roll-down marble board with large marbles; softballs, bats & gloves; assorted skates; ripstick; puzzles; games; toys; books; magazines; older worldbook encyclopedia set; quilt frames; bedding; comforters; blankets; crafts; 1987 and up Pathway magazine Ambassadors of Peace; lots of misc.

• There will also be a garage sale! •

NOTES: A good clean selection of older & working farm implements. You don't want to miss this type of farm auction!

• Food will be available by Oak Hill School. •
Any announcements made day of auction take precedence over printed matter. • Not responsible for accidents. Terms: cash or check. •

Owners - Allen & Ruth Bontrager

SAM MILLER
IN Lic.# AU10300015
V.M. (574) 642-0444

ELI MILLER, JR.
IN Lic.# AU10300064
(260) 854-2932

J&S
AUCTIONS
& REAL ESTATE, LLC

For contact with the auctioneers
on the day of the sale, call
Glendon Yoder
260-585-4030

All Types of Auctions!
Satisfaction is Our Goal!

MILLERSBURG, INDIANA

PUBLIC AUCTION

LOCATED: 2 miles north of Topeka, IN on 600 W to 500 S, then west 3½ miles.
 ADDRESS: 9520 W 500 S, Millersburg, IN 46543

SATURDAY, MARCH 7, 2026 Beginning at 9:00 am



tedder; Pequea 9' tedder; Pequea 9' rotary rake; (2) New Holland hay rakes with dolly wheel; New Idea hay rake; (2) hay wagons on air tires; Kewanee 40' double chain elevator; Kewanee 32' double chain elevator; 1240 JD plateless 32" 4-row planter; 12' Shipshe Farm cultimulcher; 12' wheel disk; 12' JD grain drill, 16-hole; 10' Brillion cultipacker; 4' crow foot plow packer; I&J 4-row cultivator; 6' double roll cultipacker;

• (12) BELGIAN DRAFT HORSES •

Team 1: Full sisters, 10 & 11 yr. old Red sorrel, Belgian mares, reg. in foal, broke to all farm machinery;

Team 2: 16 yr. old, reg. Red sorrel, Belgian mare, kid broke & 13 yr. old, reg. Red sorrel, Belgian mare, broke to all farm machinery;

Team 3: 4 yr. old, reg. Red sorrel, Belgian mare, in foal, broke to all farm machinery & 4 yr. old, Red sorrel, Belgian gelding, broke to all farm machinery;

Team 4: 5 yr. old, reg. Red sorrel, Belgian mare, broke to all farm machinery & 3 yr. old, reg. Red sorrel, Belgian mare, green broke;

Team 5: 2 yr. old, Red sorrel, Belgian gelding, broke & 2 yr. old, Red sorrel, Belgian gelding, broke;

Team 6: 3 yr. old, reg. Red sorrel, Belgian mare, open, broke to all farm machinery & 6 yr. old, reg. Red sorrel, Belgian mare, open, broke to all farm machinery;

• (9) Angus Calves, 300-550 lbs •

• FARM MACHINERY •

36 Hp diesel utility tractor, 3 point, 4-wheel drive; 4-wheel, 78 Hp power unit, built by Honeyville Weld, 2017; 4-wheel, 31 Hp Kubota power unit; New Idea manure spreader with motor; Pioneer forecart, air tires; White Horse hydraulic forecart with steering & 2-bottom 14" plow; White Horse forecart with steering; JD 820 Moco haybine 9' 9" cut; New Holland 1465 haybine with hydraulic swing; New Holland 271 small square baler; JD 336 small square baler; Sitrex RT 5200H, 4-basket

(5) gravity wagons; White Horse 712 single bottom right hand plow; (2) right hand Pioneer single bottom plows, good condition; 2-row cultivator; old 6' sickle mower; (2) old running gears; pulling boat;

• HARNESSES • COLLARS & TACK •

(9) set Bio draft harnesses; (12+) draft collars; pulling hames; pulling tugs;

• FARM RELATED •

(3) steel hay feeders, (1) for horses, (2) for cattle; (2) self feeders for cattle; (4) bunk feeders; EZ electric milker with 5 gal. bucket, like new;

• Double Buggy In Good Condition •

• GUNS •

16 gauge Ranger pump shotgun; 12 gauge Harrington & Richardson single shot shotgun; 12 gauge single shot shotgun; 12 gauge Stevens model 620 pump shotgun;

• 10' x 30' Canopy • Garden Tools • Misc. •

• HOUSEHOLD • MISC. •

Glider rocker with ottoman; loveseat; couch; rocking chair; (3) beds; (3) dressers; (3) end tables; electric sewing machine with cabinet; treadle; Formica top kitchen table; (4) chairs; 10' & 8' bench; bakers table; tea cart; bookshelf; high chair; Hitz coal stove; (2) natural gas floor lamps; (2) Coleman lanterns; buggy heater; Sunpipe; large spinner; flower pots; decor; games; books, lots of western; large pressure cooker; King Cutter; Tupperware; wine bottles & jugs; bedding; towels; carpets; camping chair; plus lots more misc too numerous to mention.

NOTES: Be sure to attend this farm auction with good quality farm equipment & horses.

• Food will be available by Honeyview School. • Any announcements made day of auction take precedence over printed matter. • Not responsible for accidents. Terms: cash or check. •



Owners - Earl & Loretta Yoder

SAM MILLER
 IN Lic.# AU10300015
 V.M. (574) 642-0444

ELI MILLER, JR.
 IN Lic.# AU10300064
 (260) 854-2932

For contact with the auctioneers on the day of the sale, call
 Glendon Yoder
 260-585-4030

**All Types of Auctions!
 Satisfaction is Our Goal!**

MILLERSBURG, INDIANA



PHONE BID REAL ESTATE AUCTION

LOCATED: 4 miles west of SR 13 on US 20 in Middlebury, IN to CR 31, then north 1 mile to CR 14, then west ¼.
ADDRESS: 16270 CR 14, Goshen, IN 46528

Taking Bids
Until

MONDAY, MAR. 9, 2026

Ending
at 3:00 pm



2.87 ACRES • HOUSE • BARN

HOUSE: 28' x 57' double wide single story on full basement with walkout, new 12' x 40' basement addition, new bathroom in basement, newly remodeled kitchen.

BARN: 24' x 48' pole type with 16' sidewalls, 12' x 24' box stall.

NOTES: Recent updates done, fully wired, natural gas. Starter home nestled in the Middlebury hills.

You can call and leave a bid anytime, where we keep high bid on voicemail 574-642-0444, until March 9, where we will **FINALIZE OVER THE PHONE AT (574) 642-0444 AT 3:00PM.**

Starting Bid
\$275,000

Public welcome to inspect real estate
February 12, 19 & 26 from 3-5pm
or by appointment with the auctioneers.



TERMS: 5% down evening of the auction (non-refundable) with balance due at closing. Closing approximately 45 days after auction with possession given at closing. Taxes will be pro-rated. Any announcements made evening of the auction take precedence over printed matter. Seller has the right to reject any or all bids.

Owner - Andrew Lehman



For contact with the auctioneers on the day of the sale, call
Glendon Yoder
260-585-4030

SAM MILLER
IN Lic.# AU10300015
V.M. (574) 642-0444

ELI MILLER, JR.
IN Lic.# AU10300064
(260) 854-2932

**All Types of Auctions!
Satisfaction is Our Goal!**

MILLERSBURG, INDIANA

PERSONAL PROPERTY AUCTION

APRIL 12, 2025 @ 9:00 AM

LOCATION

Lengacher's Auction Center 16705 Campbell Rd Spencerville, IN 46788



- Lot:1 Name: Woodworking Acre's Lilly 12yr. old mare Sire Woodworking Acre's Captin Dam Cottongrove Kandy Sire of Dam: Four Star Charisma
- Lot:2 Name: Millside Acres Candy 9yr. old mare Sire: Melody Acres SirJohn Dam: WindWood Claire Sire of Dam: Navigators Sir Garrett
- Lot:3 Name: Whispering Winds Danica 12yr. old mare Sire: Orndorff's U.C. Commander Dam: Luke's Lisa Sire of Dam: Epsom's Royal Luke
- Lot:4 Name: G.R.Y. April 12yr. old mare Sire: Detweiler's Prince's Doug Dam: C.J. Grace Sire of Dam Jay-Lou Supreme
- Lot:5 Name: A.L. April's Molly 3yr. old mare Sire: JKA Jessie James Victory Dam G.R.Y. April Sire of Dam: Detweiler's Prince's Doug
- Lot:6 Name: A.L. Lilly's Maniea 4yr. old mare Sire: JKA Jesse James Victory Dam: Woodworking Acre's Lilly Sire of Dam: Woodworking Acre's Captin
- Lot:7 Name: A.L. Lilly's Janet 2yr. old mare Sire: JKA Jesse James Victory Dam: Woodworking Acre's Lilly Sire of Dam: Woodworking Acre's Captin



AUCTIONS



- Guns-
- 22 Marlin with Scope • 22 Johnson
 - 12 Gauge Winchester
(automatic 8 Shot Slug Barrel)
 - 15 Caliber Hand Gun
(With Stainless Steel Barrel)



Samuel Lengacher **Nathan Lengacher**
#AU-10700061 **#AU-11400026**
260-750-3730 **260-413-4311**

- FARM MACHINERY / MISC. -

- 1- 82 Combine (Ready for the Field) • 2- Maschio C Tillers 7ft & 8ft with Chissel teeth Included (Excellent Condition)
- 1- 7000 4 Row John Deere Planter with No-till Culters & Foamer Bean Meeters & Corn Meeters
- 1- 10' 6" Kubota 8032R Diskbine (Excellent Condition) • 12ft Pioneer Spike Tooth (Like New)
- 1- 4160 Kubota Round Baler Silage Special With Hay Conditioner Box Mounted (Like New) • 256 New Holland Hay Rake
- 36ft Double Chain Elevator With Motor (Good Condition) • 135 Gehl Grinder • 17 Hoe John Deere Grain Drill
- 4520 John Deere Tractor Low Hrs. Forks & Tiller Included (Excellent Condition) • 2 - Auger Wagons Look Like New •
- Round Bale Wrapper (Excellent Condition) Runs With Gas Motor (Very Convenient)
- 1 - Kuhn Night Side Slinger Spreader (Like New) • New Idea Narrow Row 2 Row Super Sheller •
- New Idea Corn Picker Wide Husking Bed & Narrow Row Both in (Excellent Condition)
- 1 - 300 Bushel Hopper Wagon With Lights • 2 - Ground Driven Lancaster Spreaders Both in (Excellent Condition)
- 2 - Ground Driven Honey Wagon Spreaders With Fans (Good Condition)
- Like New Leather Press Runs By Air with Dyes on Stand With Foot Pedal • Torch Sets With Gauges • Freon Pumps
- 1850 Oliver Good Condition Approx. 3,000 Hrs. Engine all Rebuilt Ready to go Great Paint Job
- Water Pumps • Sye's • Cross Cuts Saws • Lard Press • Lots of Wrenches • Lots of Misc. Items Not Mentioned

- HOUSEHOLD ITEMS -

- 2 Gas Lanterns • 4 Kerosene Lights • 3 Kerosene 1 burner (new) • Strawberry Boxes • Canning Jars and Rings
- Stainless Milk Strainer & Bucket • 2 Burner Coleman Camping Stove • Steamer for Grape Juice • Some Bedding
- 3 Bake Ovens set on Burner • Glass Pitcher with Glasses • Ice Chest • Water Jugs • Suit Cases • Scales (old)
- Glass Dishes (some new) • Sewing Basket • Step on Garbage Disposal (new) • Stainless BBQ Grates • Milk Cans
- Wood Icecream Freezer with Electric Motor • 5 Gal. Buckets (empty) • Good Used Umbrellas • Cement Tools
- Walk Behind (7 Shovel) • 22" Walk Behind Power Lawnmower • Mega Laundry Sprinner • Some Tupperware
- Stainless Pots and Pans • Butane - Electric Irons • Tomato Strainer • Small Pig Feeder • 2- Wall Heaters
- 2 Antique Baby Buggies • Lazy Boy Couch Set 2 Sofas/ Recliner • Stainless Steel Set • Bake Oven (Gas) •
- New Church Bell • Knee Hoe Desk • Old China Cupboard • Lots of Household Items Not Mentioned

Andrew & Susann Lengacher
(Rosamay) DECEASED (Victor)

David & (Amy) Graber
DECEASED



- Curio Cabinet • Clocks • Kitchenn Cabinet • Small China Hut • Small Buffet • Wash Room Cabinet
- Small Stand / Sink • Mirrors • Grandfather Clocks • Rocking Chair • Glass Cupboard • Quilts • Antique Light
- Light Stands • China Sets • Pot & Pans • Tea Kettles • Tubs & Baskets • Pie Holders • Glass Bowls & Vases
- Kerosene Lamps • Salad & Fruit Bowls • Doors • Dishpans • Water Set • Kerosene Heaters



★ ★ PHONE BID ★ ★ REAL ESTATE AUCTION

PROPERTY LOCATED: 1½ miles east of Shipshewana, IN on 250N to 675W, north 4 miles
ADDRESS: 6645N 675W, Shipshewana, IN 46565



3.8 ACRES • HOUSE • SHOP • BARN



Phone bids accepted until 4:30 PM on Tuesday, March 31, 2026.

HOUSE: 1½-story with 3,553 sq.ft., 30'x48' attached garage/wash room with full kitchen and in-floor heat, wrap around open front porch, 6'x30' rear open porch, octagon sun room, full walkout basement, 5 bedrooms, 2 full baths, LP lights on main level, natural gas, in-floor hot water heat new in 2020, fully wired, 2 new attic fans, newer water softener, natural gas backup furnace, oven & 21 cu.ft. refrigerator will stay



Secluded backyard with privacy fence and campfire area

SOLAR SYSTEM: 48V system with (8) gel batteries and (8) solar panels that are 4 years old, 8K auto-start genset

SHOP/BARN: 40'x64' with 40'x40' shop area, 10'x12' attached motor room, lined and insulated and fully wired, second story is 20'x64' with 10' ceiling, 24'x40' barn area that has 3 box stalls and tack room

500-gallon air tank

BARN: 20'x24' with 2 box stalls, 1 tie stall and tack room

STORAGE BUILDING: 16'x24' with 8'x16' insulated area with wall heater

GARDEN SHED: 8'x12'



Approx. 1 acre of woods with an 8'x12' cabin and 4'x12' open front porch
Mature shade trees • Pigeon River frontage

Public welcome to inspect this real estate from 4:30-6:30 PM on Feb. 24, March 3, 10 & 17 or by appointment with the auctioneers.



Phone bids will be accepted by Chupp Auctions until 4:30 PM on Tuesday, March 31, 2026. Starting bid is \$525,000. For bidding updates or to place a bid, contact Chupp Auctions at 260-499-0216 or 260-499-0093.

TERMS: 5% down (non-refundable) upon accepted offer on March 31, 2026 with balance due at closing. Closing approx. 45 days after the auction with possession given July 6, 2026 or sooner. Seller agrees to pay \$1500 rent per month from day of closing to date of possession. Taxes to be pro-rated. Sellers have the right to reject any or all bids. Any announcements made by the auctioneer take precedence over printed matter.



Owners: JOHN & MARLENE YODER



LYLE CHUPP • 260-499-0216
IN #AU08800826

DALE CHUPP • 260-499-0093
IN #AU19800030





PHONE BID REAL ESTATE AUCTION

**SHORT
NOTICE!**

PROPERTY LOCATED: west of the SR 13 & US 20 junction in Middlebury, IN on US 20 to CR 22 (Orpha Dr), west 2¼ miles to property
ADDRESS: 14991 CR 22, Goshen, IN 46528

7.06 ACRES • HOUSE • SHOP/BARN • KENNEL

Phone bids accepted until 3:00 PM on Friday, March 13, 2026.

HOUSE: 32'x62' 1-story with 13'x19' bumpout, 3 bedrooms & 1¾ baths, master bedroom has a large walk-in closet and bathroom, full finished basement has 2 bedrooms, ¾ bath, full kitchen and large can room, 24'x36' attached garage is lined and insulated with ½ bath
SHOP/BARN/KENNEL: 60'x75' with 10' wraparound overhang, 20'x75' is barn area with 5 box stalls and hay loft, 40'x60' shop area, lined and insulated with drain and water hydrants, 8'x12' office area. Kennel is 15'x40' with 9 runs, lined and insulated and large outside play area

HORSE SHELTER: 10'x16'

SOLAR SYSTEM: (18) panels, (3) 100 AH lithium batteries (new in 2023), 48V system

500-gal LP tank • Natural gas • Concrete driveway



Public welcome to inspect this real estate Wednesdays from 4:00-6:00 PM or by appointment with the auctioneers.

Phone bids will be accepted by Chupp Auctions until 3:00 PM on Friday, March 13, 2026. Starting bid is \$550,000. For bidding updates or to place a

bid, contact Chupp Auctions at 260-499-0216 or 260-499-0093.

TERMS: 5% down (non-refundable) upon accepted offer on March 13, 2026 with balance due at closing. Closing approximately 45 days after the auction with possession given June 1, 2026 or sooner. Taxes to be pro-rated. Sellers have the right to reject any or all bids. Any announcements made by the auctioneer take precedence over printed matter. **This property is being sold contingent upon the sellers purchasing another property.**

Owners: DARYLE & DORA MILLER



LYLE CHUPP • 260-499-0216
IN #AU08800826

DALE CHUPP • 260-499-0093
IN #AU19800030

★ PHONE BID REAL ESTATE AUCTION ★

PROPERTY LOCATED: 3½ miles north of Shipshewana, IN on SR 5 to SR 120, east ¼ mile to 775W, north ¾ mile
ADDRESS: 7800W 675N, Shipshewana, IN

2.68 ACRES • HOUSE • BARN

HOUSE: 1-story home with approx. 1,442 sq.ft., 15'x20' attached wash house, full basement, 2 bedrooms, 2 baths

BARN: 24'x50' with 4 tie stalls, 24'x30' is being used as a shop & buggy storage area

Backyard has a campfire area with privacy fence
All pastures reseeded in 2025
(5) Paddocks with all new fence



Public welcome to inspect this real estate Tuesdays from 3:00-5:00 PM or by appointment with the auctioneers.

Phone bids will be accepted by Chupp Auctions until 4:00 PM on

Tuesday, March 31, 2026.
Starting bid is \$300,000.
wFor bidding updates or to place a bid, contact Chupp Auctions at 260-499-0216 or 260-499-0093.

Owners: NATHAN & ELLA LEHMAN

TERMS: 5% down (non-refundable) upon accepted offer on March 31, 2026 with balance due at closing. Closing approximately 45 days after the auction with possession given at closing. Taxes to be pro-rated. Sellers have the right to reject any or all bids. Any announcements made by the auctioneer take precedence over printed matter.

LYLE CHUPP • 260-499-0216
IN #AU08800826

DALE CHUPP • 260-499-0093
IN #AU19800030



AUCTIONS

LAND AUCTION

STEUBEN COUNTY, IN

WEST FARM
223 +/- Acres
Tracts 1, 2, 3, 4, & 5

EAST FARM
129 +/- Acres
Tracts 6, 7, 8, 9, & 10

352 +/- Total Acres

- Offered as Ten (10) Tracts
- Potential Development / Nearby Utilities
- Productive Tillable Crop Acres
- Recreational Opportunities & Mature Timber
- Investigate Potential Homesites
- Farm Outbuildings
- 4 Bed / 3 Bath Home on Semi-Wooded Lot
- 1765 S Bill Deller Rd, Angola, IN 46703
- Open Lease for 2026



AUCTIONEER:
JOHNNY KLEMMER | IN AU# 12000053
SELLERS: MARY JANET KANKAMP TRUST, ET AL



AUCTION REPRESENTATIVES:



JAKE HOGAN
(765) 366-6328



BROCK SOLMOS
(574) 360-5520



ONLINE + PHONE BIDDING
auctions.gfarmland.com
Call 765-426-6666 for details
auctions@gfarmland.com



REAL ESTATE AUCTION

- PHONE BID -

LOCATED: 3 MILES EAST OF MIDDLEBURY ON 250 NORTH. ADDRESS: 11335 W 250 N MIDDLEBURY, IN 46540

THURSDAY, FEBRUARY 26, 2026 AT 5:00 PM



3.28 ACRES - HOUSE - BARN - SHOP AREA

House: 1.5-Story, 2,560 sq. ft. home with full walkout basement, 4 bedrooms, 2 full bath, additional kitchen in upstairs. 8x32 attached porch w/ roof. 14x14 attached deck w/ steps, leading to upstairs. LP appliances, a lot of new windows in 2024.

Barn: 24x46 w/ attached 16x46 enclosed Tramp Shed, 8x46 overhang, 4 tie stalls, 2 boxstalls, full hayloft. Buggy/Shop area.



Upstairs Kitchen



Some New Fencing in 2024 - New Water Heater - Water Softener - Honda Motor for Water Pump - Great Pasture Area - Arborvitae Trees

SELLERS: RALPH N. BONTRAGER

STARTING BID: \$290,000

OPEN HOUSES:

January 28th, February 4th & 11th,
3:00 - 5:00 PM or by appointment.

AUCTIONEER NOTES:

This property would make a great starter home for a young couple. Or even a smaller family. Great location between Shipshewana and Middlebury. Ready to move in.



#AU12200020

JERRY SLABACH JR.
260-350-9280

TERMS

5% down evening of auction (non-refundable) with balance due at Closing. Closing approximately 45 days after auction with possession given at Closing. Taxes will be prorated. Seller has the right to reject any or all bids.

“PHONE BID” REAL ESTATE AUCTION

Income
Property

Tuesday, March 24, 2026

Ending at 4:30 pm

Location: 5865 W 200 N Shipshewana, IN

South of Shipshewana on SR 5 to 200 N, east approx. 2 miles.

Starting Bid
\$1,500,000

15.78 Acres • House • Shop • 2 Barns • 2 Duck Barns

HOUSE: Older 2-Story Farm House on a full basement, approx. 1450 sq. ft. on main area, 16'x20' entrance, 1 bedroom & 1 full bath on main area, 5 bedrooms & 1 full bath upstairs, new siding, windows & insulation in 2022. EZ Glo Heat, LP Lights

SHOP: 34'x102' Lined and insulated with bathroom & kitchen, middle section is 30'x40' with an upstairs. LP heat.

BARN 1: 42'x102' with 4 box stalls & 4 tie stalls, open hay mow & plenty of storage.

BARN 2: 40'x70' older hiproof barn with newer metal & tramp shed area. This barn was mostly used for storage.

DUCK BARN 1: 40'x300' 2 stage, max cap. of 5,600 per flock, with a 4 week cycle, average of 13 flocks per year. Raised wire flooring with scrapers and manure storage of 120,000 gal. Completely rebuilt in 2015. Barn has its own well with a 15kw Kubota Diesel genset for auto watering & feeding. New insulated curtains.

DUCK BARN 2: 42'x693' 2 stage, max cap. of 10,100 per flock, with a 4 week cycle, average of 13 flocks per year. All shavings, with a manure bunker for approx. 1 year storage. Insulated Curtains & controllers new in 2021. Tube heaters new in the last 2 yrs. Barn was built in 2005 but is in great condition! Barn has its own well with a 21kw Kubota Diesel genset for auto watering & feeding.

THIS OPERATION INCLUDES: All equipment to run including, New Holland skidloader, 2 shaving spreaders, with wheel horse tractors, pressure washers, spare heaters, Dewalt tools, spare medicators, etc. The duck barns are currently contracted with Maple Leaf Farms, with a new contract available to the new owner. Sellers agree to provide all training, guidance, & help needed to the new owner!

SOLAR SYSTEM: 12-210 Watt Panels, 1-700 AMP hr. Steel Case Battery

NOTES: Natural Gas, 1000 Gallon LP Tank, 6'x10' Pony Shelter, 12'x18' Horse Shelter, 18'x19' Stamped Concrete Patio, 26'x33' Concrete Slab with Basketball Rim.



Sellers: Jarrin & Leah Miller

Public welcome to inspect property Mondays, Feb. 9, 16, & 23 from 3:00 - 5:00 PM or by appt. with the auctioneers.

Phone bids will be accepted by Detweiler Auctions until 4:30 pm on Tuesday, March 24, 2026. Starting bid is \$1,500,000. For bidding updates or to place a bid call Detweiler Auctions at 260-336-9495.

TERMS: 5% down evening of auction (non-refundable) upon accepted offer March 24, 2026, with balance due at closing. Closing approx. 45 days after auction, with possession given November 2, 2026. (New owner will receive all income from closing until possession) Taxes will be pro-rated. Seller has the right to reject any or all bids. Property sells not contingent upon financing, appraisals, and/or inspections. Any announcement made the day of the auction take precedence over printed material.

DETWEILER AUCTIONS, LLC
Our Goal Is Your Complete Satisfaction!

Aaron Detweiler
AU10900104
260-336-9495

Shipshewana, IN
AC32100014

Freeman Detweiler
AU10900105
260-350-3307



“PHONE BID” REAL ESTATE AUCTION

**Starting Bid
\$395,000**

**Tuesday, March 24, 2026
Ending at 4:30 pm**

Location: 5495 W 200 N Shipshewana, IN 46565
South of Shipshewana on SR 5 to 200 N, East approx. 2 miles.



3.10 +/- Acres • House • Barn/Shop

HOUSE: 26' x 64' 1998 Manufactured home with full walk out basement, 14' x 16' attached entrance, 3 bedrooms, 2 full baths, laundry room, 14' x 16' Vinyl patio, natural gas boiler, LP lights.

BARN/SHOP: 26' x 40', with 8' overhang. 2 Tie stalls, 1 boxstall, 24' x 26' Shop area.

SOLAR SYSTEM: 4-400 Watt panels, 1-300 AMP HR Lithium Battery, 24-Volt System.

NOTES: 1000 Gallon LP Tank, Natural Gas, Mature Pine trees, 47' x 60' Concrete pad between house & barn.

Seller: (Mose) Katie Miller

Public welcome to inspect property Mondays, February 9, 16 & 23 and March 2 from 3 - 5:00 PM or by appt. with the auctioneers.



Phone bids will be accepted by Detweiler Auctions until 4:30 pm on Tuesday, March 24, 2026. Starting bid is \$395,000. For bidding updates or to place a bid call Fritz Detweiler at 260-350-3307.

TERMS: 5% down evening of auction (non-refundable) upon accepted offer March 24, 2026, with balance due at closing. Closing approx. 45 days after auction, with possession given at closing. Taxes will be pro-rated. Seller has the right to reject any or all bids. Property sells not contingent upon financing, appraisals, and/or inspections. Any announcement made the day of the auction take precedence over printed material.

AUCTIONS

DETWEILER AUCTIONS, LLC
Our Goal Is Your Complete Satisfaction!

Aaron Detweiler
AU10900104

Shipshewana, IN
AC32100014

Freeman Detweiler
AU10900105
260-350-3307

Rapid Release THERAPY

POWERFUL, SAFE, EFFECTIVE!



Therapy in the Palm of Your Hands!



Rapid Release™ is helping our equestrians, trainers and Veterinarians care for their horses and themselves with our patented high-speed vibration. FDA Class 1 Medical Devices approved for human and animal use with amazing results!

HEALTH/HOME



Cordless PRO3

Includes 2 rechargeable batteries and charger

Retail Price
\$1199

- 5 built-in treatment surfaces each creating a different effect
- Uniquely suited for extremities
- Meticulously engineered and balanced mechanism for smooth operation
- No attachments to change or lose
- The Pro3 is ideally suited for horse and human care. What is it worth to you?
- Treatments typically last just 2-5 minutes
- For pain, muscle tension and movement
- Designed and built to withstand professional use

90-Day Money Back GUARANTEE!

TRY BEFORE YOU BUY!

Rental units available for \$100 a week. Purchase a unit within the first 30 days of signing rental agreement and we'll use your rental money towards the purchase price.

PRO-AM Massager



5 IN 1 TREATMENT

- High speed vibration
- 4 speeds
- 5 built in treatment heads
- Self contained rechargeable battery
- Full body therapy
- Economical



\$799

- 1. Treatment Disk:** Head-to-toe, whole body therapy
- 2. Large Tip:** Go-to for most applications. (*Targeting*)
- 3. Soft Tip:** Use on sensitive or tender areas (*Bony Prominences*)
- 4. Power Band:** Offers most intense vibration (*Scraping*)
- 5. Acupoint:** Penetrates deep into smaller, troubled spots. (*Trigger Points*)

Canada Dealer:
West Paw Kennel Supplies
4340 Lichty Rd RR1
Wallenstein, ON N0B250
519-698-0707

Distributed by:

Keystone Sales

717-715-3498
332 Hollow Road
Quarryville, PA 17566

Dealer inquiries welcome.
Call for wholesale pricing.

COUNTRYSIDE

Health Products

717-786-6065

Samuel & Linda Glick

4208 Red Well Dr., Gordonville, PA 17529

Call for Testimonials



The Micronutrient Company

Protection of dangerous EMF radiation and 5G

Boost Products



Formulated and science proven by the worlds top professor in vitamins and cancer.

Micro daily is indeed the worlds most scientifically validated supplement

Ask about our new products



Health & Goodness - Micro Nutrients

Dr. Prasad's Core4 Bundle offers a comprehensive approach to wellness, targeting brain, cellular, gut, skin and heart health. The combination of Micro Daily EMF, Probiotic Daily, Collagen Daily and Omega3 Daily ensures that your health is taken care of from all angles. From boosting immunity and improving brain function to promoting gut health, revitalizing skin and supporting a healthy heart, this bundle has it all.

Holistic Health Solution: targets key areas of health.

Superior Value: enjoy significant savings when you purchase the bundle.

Effortless Wellness Routine: Four products designed to work together for maximum benefit.

Looking to increase your health and well being? Great results for conditions and chronic illnesses.

- Diabetes, sugar related
- Hormonal health and obesity
- Heart and blood pressure
- Emotional and anxiety
- Parkinson's & Alzheimer's
- Thyroid gut and brain issues
- Food allergies
- Inflammation

Basic Hydro Bundle



Core 4 Bundle



Also for children Micro daily gummies

Organ and bone health • Autism • Hearing issues • Focus issues

These statements have not been evaluated by the FDA. This product is not intended to diagnose, treat, cure or prevent any disease

No More Body Odor! Deodorant Supplement, that just works.

Call Lydia
330-403-3277
P.O. Box 289,
Berlin OH 44610

You Can Now
Smell like mint
instead of

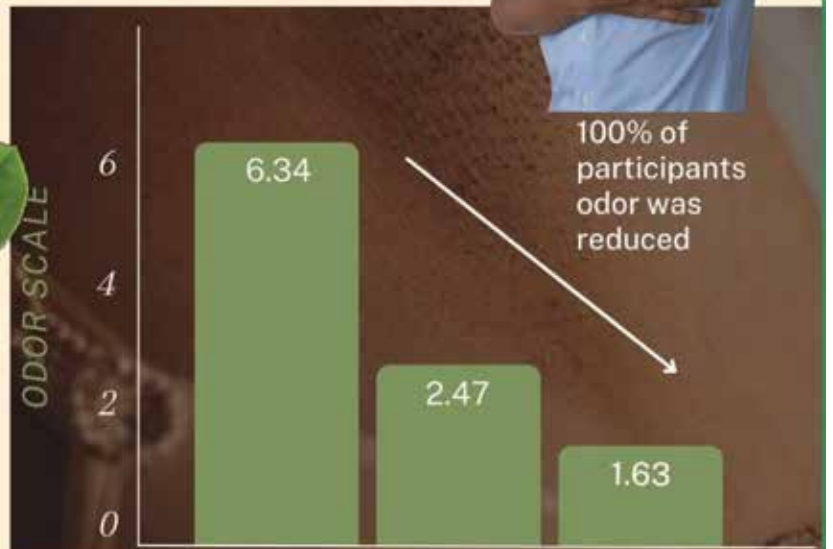

HEALTH/HOME

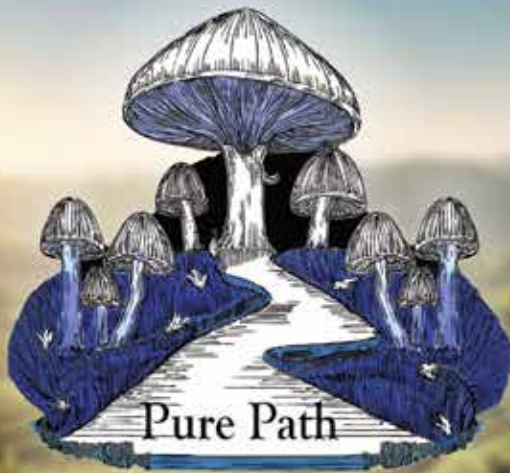

“Lions Mane Talk”

High in the clean, cool air of the Appalachian Mountains, Mushroom Maiden Farm tends its Lion’s Mane mushrooms with the same care a family gives its garden. Grown in a quiet tunnel, away from impurities and noise, each fruiting body is nurtured slowly and naturally. From these American-grown mushrooms come our pure, tested capsules made without fillers, additives, or anything unnecessary.

Many folks today are finding value in simple, time-trusted natural supplements. Lion’s Mane has long been appreciated for the way it supports the body’s own defenses and helps the mind feel clear and steady. Taking a small dose each morning can become a gentle habit, like stepping outside to breathe the dawn air. Over time, people report feeling more alert without any sense of unease or jitters. Some find it helps them meet the day with calmer thoughts and a lighter spirit.

Winter can test even the strongest among us. Cold winds, heavy chores, and long nights can place extra strain on the body. That is why having something wholesome “on board” can be a comfort, a steady companion through the harder months. Mushroom Maiden Farm’s Lion’s Mane capsules, made from the full fruiting body and carefully tested, are an easy addition to the morning routine. I take them each day myself, and it requires no more effort than a sip of water.

If you seek a natural way to support your well-being through the seasons, Mushroom Maiden Farm is pleased to offer its harvest to you, pure, simple, and grown with respect for God’s creation.

The Mushroom Maiden
Daria Novak

Pure Path Distribution LLC
P.O. Box 151 Emmitsburg, MD 21727
1-888-401-7747

SPRIGS®

Now Hiring

FULL-TIME SALES ASSOCIATE

Represent Sprigs at tradeshows across the country and help connect families with products they trust.

- Full-time position
- Get free products!
- Can be remote
- Engage customers through in-person sales & education
- Travel required
- Sales or event experience preferred

If you have a passion for health and enjoy teaching people about health this can be for you.

For more information or to apply, please email leroymler@sprigs.life or call **330-473-4147**.



Take 10% OFF Our Price **\$159**



EVERYDAY OILS COLLECTION

INCLUDES:

- | | |
|---------------------------|------------------------|
| Frankincense, 5 ml | Joy, 5 ml |
| Lavender, 5 ml | PanAway, 5 ml |
| Lemon Vitality, 5 ml | Purification, 5 ml |
| Peppermint Vitality, 5 ml | Stress Away, 5 ml |
| Tea Tree, 5 ml | Thieves Vitality, 5 ml |

Ever wanted to try oils?

This is the perfect bundle to start. YL most popular oils, all in one bundle.



SPECIAL
Order for 3 months in a row a I'll pay your shipping

YOUR CHOICE OF FREE GIFT

1. FREE SHIPPING & TAX ON FIRST ENTIRE ORDER

2. FREE PRODUCT GUIDE & OILY LIFE GUIDE BOOK (Value \$20.00)



(Mention Coupon with your order)

Our Price **\$215** Take 10% OFF



Ningxia Red Loyalty Bundle:
+ Receive 2 FREE Oils

Our Price **\$132** Take 10% OFF



Ningxia Red 14-Day Reset Bundle
+ Receive 1 FREE Oils

YOUR FIRST ORDER INCLUDES

- 34% off your entire order
- 24% off future orders
- No obligation to reorder
- I can place your orders for you
- 4 pg. monthly newsletter

For more questions and information contact:

Martha - 941-504-8752 - 5076 Yackey Dr. NW, Strasburg, OH 44680

My Hair Grew Back!

Place Your Order Today!
330-403-3277

It Works!



P.O. Box 289
4860 E Main St., Berlin, OH 44610

NucleoGenex

Heal Your Gut.....Change Your Life!!



"Gut Health Triad"

The Greatest weight loss pills on the market



All Natural Appetite Control!

Customers are having incredible results!

330.275.8602 or write to: 28800 TR 171 Fresno OH 43824

JUMPSTART YOUR 2026 WEIGHT LOSS NOW!



GLP-1 to Reduce Cravings by 40% Without Injections, Naturally.

While we don't believe in short cuts when it comes to dealing with your health, we do think losing weight consistently and easier than in the past is vital to your ability to stick with a health program. You are able to see the results with your own eyes and that gives you belief that you are getting better and healthier because in many ways you are! You have probably heard a lot about GLP-1 in the news and seen people lose a lot of weight with this so called "miracle drug." However at Nutrition Wellness Center we want to make sure speed isn't the priority, but **long-term health and permanent change** is what we are striving for. But if there is a safe shortcut we are open to it! Well now with this All Natural GLP-1, things have changed for the better.

Science meets self control: we are supporting appetite and controlling cravings by stimulating bitter taste receptors, which enhance the release of appetite gut regulating peptides which potentially reduce hunger and curb cravings. Up to a 40% reduction in cravings within the hour and most importantly no injectable weight loss medications! This is huge news! GLP-1 is even being talked about in DC at the White House, while they discuss keeping the cost of drug prices, guess what? Our product is all natural!

Call today to get on our waitlist or be one of the lucky first 35 members to get to try our new Weight Loss for 2026 that includes all natural GLP-1, right away with proper testing and recommendations first!

**Call 1-800-222-3610
Just mention all
natural GLP-1.**



Are you having problems with Brain Fog, Moodiness, Anxiety, Digestive Issues, Hormonal Imbalance?

Try using Happy Juice!



- Boosts your Mood, Motivation, and Metabolism
- Supports your Second Brain, Your Gut, with Specific strains of Good Bacteria for Mental Wellness
- Enhances Your Mental & Physical Energy Levels
- Reduces Bloating, Supports Digestion, Balances Hormones
- Helps Normalize Gut, Immune, and Brain Function
- Reduces Belly Fat
- Increases the Production of the "Feel Good" Neurotransmitters like Dopamine, Serotonin, and Gaba Levels

happy is a habit.
happy is a habit.
happy is a habit.



For more Info Please Contact...



Verna Hershberger
@ 330-231-4482
Or Ina Wengerd after 5PM
@ 330-698-0328



AMARE KIDS

- Helps regulate Serotonin and Dopamine — the feel-good brain chemicals
- Safe, natural, and non-habit forming
- No artificial colors, flavors, or preservatives
- All products are 3rd-party tested
- Supports emotional balance and helps reduce anxious feelings in children
- Promotes calmness and stress resilience without making them drowsy
- Contains natural ingredients like Affron® Saffron, Holy Basil, and Rosemary, clinically studied for mood support
- Encourages better focus, patience, and emotional regulation



These statements have not been evaluated by the FDA and do not claim to diagnose, treat, cure, or prevent any disease.

HEALTH/HOME

IT'S YOUR GUT. TIME TO SUPPORT IT.

The best products in their classes offering one-of-a-kind support for all lifestyles.



Heal Your Gut, Change Your Life

THE GUT HEALTH TRIAD

Giving your microbiome the tools it needs to support a healthy digestion. Studies show that a healthy digestive process can lead to better absorption of nutrients, which would include the vitamins and nutritional supplements you take.

This is not just a band-aid.

Let us help you get to the root cause of your problems.

- Hormone Problems
- Thyroid Issues
- Lack of Energy
- Food Allergies
- Brain Fog
- Bad Body/Feet Odor
- Chronic Fatigue
- Indigestion
- Constipation
- Irritable Bowel Syndrome
- Sugar Cravings
- Chronic Pain
- Poor Immunity



RED Neurotrophic Coffee

One of the healthiest and finest coffees you can drink.

Less than 2% of all the worlds' coffee roasters use this proprietary patented and scientific technology that produces a true lower-acidic coffee that is both delicious and smooth.

No flame is ever applied, so our coffee is never burnt, never bitter, and always draws out the richest flavor profiles to deliver a consistent and exceptional tasting coffee experience every time.

Wholesale Inquires Welcome!

100% organic

FINALLY infrared roasted beans available!!!

perfect for espresso machines that take whole beans!

Finally whole beans we can actually trust...

Crafted from 100% organic Arabica beans this blend is infrared roasted to perfection for a smooth, low-acidity cup that's full-bodied and bursting with flavor.



Try Our DNA Testing

Easy, do-it-at-home kit -saliva swab- testing for 18 "actionable" genes including MTHFR gene and genes related to heart, gut, brain, detox, immune, inflammation, and hormones.

...and Customized Nutrition

Turn your DNA report into nutrition made just for you, allowing your gut to heal and feed your weak spots.



Lose Weight Naturally. WHAT IS CURBIX?

Curbix is a cutting-edge natural alternative to synthetic GLP-1 medications, designed to support your metabolic health without the drawbacks of prescriptions, needles, or synthetic chemicals. By leveraging the power of nature and science, Curbix provides a safe, effective, and sustainable solution for managing appetite, metabolism, and overall wellness.

**Muscle Preservation / Natural Appetite/ Regulation
Blood Sugar Balance / Metabolic Enhancement /
Hormonal Harmony**

To order products or for a FREE information pack please reach out to us via Phone or Mail (570) 917-4884 ext. 3
• Elevate Nutrition: 7814 State Route 147, Sunbury, PA 17801

LEAKY GUT STOPS HERE



IT IS OUR ABSOLUTE
PRIVILEGE LEADING YOU TO
YOUR JOURNEY TO BETTER HEALTH.

Call , Text or Write: Arlen & Fannie Erb

740.552.1287 26841 SR 621, Fresno, OH 43824

HEALTH/HOME

Do it yourself wellness from the comfort of your home

THORNE®

Meaningful insights. Personalized plans.



P.O. Box 289, Berlin OH 44610
330-403-3277

HEALTH/HOME

NOW THAT IS WHAT I WANT FOR

Valentines Day



- Relax Far Infrared Sauna
- In Home Unit That Works Well
- Uses minimal power, 120 Watts – 60Hz, 1400 Watts max



7296 Ridge Road, Fresno OH 43824
Call 330-997-3492



CHRISTIAN HEALTHCARE SPECIALISTS

Discounted Packaged Pricing tailored to the needs of Plain Communities

We offer over 20 procedures and surgeries to self-pay patients in our facility in Newaygo, Michigan.

ENDOSCOPY	\$1,300
COLONOSCOPY	\$1,450
HERNIA REPAIR	\$3,400-4,500
BREAST BIOPSY	\$3,500
PILONIDAL CYST	\$2,800

We serve the Amish community throughout the Midwest.

Call for additional services or to schedule a consultation.

*Cost includes anesthesia, physician, facility, surgical consultation (if needed).
Does not include pre-op tests, pathology fees
Overnight accommodations can be arranged.
Payment required at the time of service.

53 W. Wood St. Newaygo, Michigan
Contact our Amish advocate at (231) 707-2313

Pressure Point Mat Set

Lay back, breathe deep, and let the tension melt away.

Great
Valentines Day
Gift!

\$138 for the mat.
Add **\$12** for shipping.



Studies have shown up to 40% improvement for, stress, muscle soreness, and sleep quality after regular use of the mat for 20-30 minutes before bed. Journal of Sleep Therapy 2015

HEALTH/HOME



Unroll your pressure point mat and pillow on a flat surface and ease onto it slowly, allowing your body to adjust. The gentle pressure of over 4,000 pressure points works to stimulate circulation, release muscle tension, and support relaxation. Start with 10-15 minutes a day and gradually increase to 20-40 minutes as your body gets used to the sensation. Use daily or as needed to support deep rest, stress relief, and full-body rejuvenation.

I absolutely love this pressure point mat! It's become a part of my daily routine and helps me relax and unwind like nothing else. I've even gifted it to friends, and they're obsessed with it too. Highly recommend for anyone looking to relieve tension and feel amazing! - WTHN Client

What's Included:

- High-quality coconut fiber and linen WTHN Pressure Point Mat
- Luxe memory foam and linen WTHN Pressure Point Pillow for ultimate comfort
- On-the-go linen carrying case for WTHN Pressure Point Pillow and Mat
- Detailed how-to guide with step-by-step instructions and Pressure Points for healing at home and on to go.

Name _____

Address _____

City _____ State _____ Zip _____

Phone _____

Qty _____ Price EA _____ Sub Total _____ Shipping _____ Total _____

OH residents add 7% sales tax

*These statements have not been evaluated by the Food and Drug Administration. This product is not intended to diagnose, treat, cure, or prevent any disease. The information provided on this site is not intended to replace or serve as an alternative to advice from healthcare professionals. Results may vary.

The Blooming Thistle, 216 West Stewart Ave, West Lafayette OH 43845 • Call 740-291-9848



To place an order contact your
Michiana Distributor

Michiana Aloe Sales • 269-503-0014
Attention: Ervin & Rosemary Mast
32251 Hagelgans Road • Burr Oak, MI 49030

Capsules

Same great product, better value. Each capsule is equivalent in active ingredients to 2 fluid ounces of our 99.7% Aloe Vera Leaf Juice. Shape and small size for easy swallowing.

4X Concentrate

One quart of our Extra-Strength Aloe Vera Juice is equivalent, in active ingredients, to a gallon of our original Aloe Vera Leaf Juice.

EXCELLENT FOR: Digestive aid, Acid reflux, Joint health, Immune builder

I've tried almost every kind, form and brand of Aloe on the market and even had adverse reactions to many of them. This is best aloe on the planet!!! Hope it blesses you too!
— John G.

Love this product! We have been using this product for years! — Shirley V.

HEALTH/HOME





Family-owned local business.
Sarasota, FL.

You can **stop** sleep breathing disruptions tonight.

"I am well pleased with the Sleep Breathing Support. The nice part is I no longer have to use a CPAP machine. I am refreshed, rested and ready to go when I wake up."
Elva Chupp

Crafted with a bouquet of natural herbs.

Lobelia, used in small doses, can increase the level of respiration. Because the lobelia causes you to breathe more deeply and steadily, it keeps the whole disruptive cycle from even beginning.

Thyme improves the ability of the lungs to exchange carbon dioxide for oxygen and makes an excellent contribution to maintaining sufficient respiratory amplitude.

Chamomile aids the subject in relaxing.

Cramp Bark helps the upper trapezius muscles to loosen.

Hi, I'm Steve Frank.

I have sleep-breathing disruptions at night. I spent years researching the condition and understanding the true cause. After many years, and with my knowledge of herbs, I found an amazing combination that supports deep, steady breathing all night long. This patented blend works great for nighttime sleep-breathing disruptions commonly associated with aging. I haven't worn any mask or tubes in years, and I sleep great. I hope you can too.
Sweet Dreams.



Replace your restless nights with Sleep Breathing Support™

Sleep Breathing Support™ by Nature's Rite is a natural way to reduce sleep breathing disruptions and achieve a restful night.

30 Capsules ~~-\$45.99~~ **-\$36.79**

Sleep related breathing disruptions ruin the sleep of an estimated 25 million Americans on a regular basis. Since sleep disruptions can disturb sleep without completely awakening the subject, there are likely millions more undiagnosed sufferers. The condition prevents the sleeper from entering rapid eye movement (REM) and delta sleep—causing them to become anxious, cantankerous and tired during the day. Additionally, due to the nature of the condition, it causes blood oxygen levels to be lower than normal for very prolonged periods of time. This is damaging to the brain and heart in particular.

Treatment options can include weight loss, nasal decongestants, surgery, and oral appliances. Devices, such as a continuous positive airway pressure (CPAP) machine, are commonly used for moderate and severe sleep breathing disruptions. A CPAP device is a forced air mask, worn during sleep that ensures proper inhalation. Experience has shown that 60 percent of patients are not able to tolerate the equipment and ultimately discontinue using it. Others develop respiratory infections from the mask. Sleep Breathing Support™ was designed to do what the above solutions can't address the real cause of the condition.

The Cause

When we enter stage two sleep in preparation for REM sleep, where dreaming occurs, muscular activity is inhibited. It is called "reduction of muscle tonus." This is a function that occurs primarily to keep the dreamer from physically acting out the movements of his or her dreams.

If you want to know whether it will work for you, then you have to try it.

It is accomplished by suppressing the flow of signals from the brain along the spinal cord. Unfortunately, in those who struggle with sleep breathing disruptions, the reduction in muscle tonus allows the soft palate to sag and the signal from the brain to the diaphragm that keeps you breathing gets inadvertently reduced in strength.

The result of this is that upon entering stage two sleep, the breathing becomes shallower, the blood oxygen level drops and the carbon dioxide level rises until the brain intervenes and causes the body to make a large and immediate inhalation. This causes a large pressure differential in the pharynx and literally sucks the sagging soft palate into the airway. This obstructs the flow and causes a loud snort, partially or fully awakening the subject.

The Solution

So you see, the problem is not the sagging soft palate. The problem is not the rapid inhalation that sucks your soft palate into the airway. The problem is the reduced ability of the signal from your brain to produce sufficient breathing amplitude from your diaphragm. The appropriate intervention is to enhance the ability of the brain to communicate with the diaphragm so that you breathe deeply and steadily throughout the night. **That is exactly what the combination of herbs in Sleep Breathing Support™ is intended to do.**

Limited Time Offer!
Enjoy 20% OFF Featured Product + FREE SHIPPING on orders over \$50. Just mention you saw us in The Busy Beaver of Michiana when you call.

CRAFTED IN THE USA AND BACKED BY OUR 30-DAY MONEY-BACK GUARANTEE.

*Applies to the first bottle of any product.

READY TO ORDER?

Call us today (800) 991-7088. Pay by electronic check or credit card.
WHOLESALE INQUIRIES: (941) 500-3101 – Request your **FREE product catalog**
Nature's Rite – 8126 Uzita Dr. Sarasota, FL. 34240

HEALTH/HOME

FREE BRAND-NEW HEALTH TELESEMINARS

Call and Listen Anytime – 24/7!



BEDWETTING *Part 2*

1-833-640-4661

Under 15 minutes long!



INFERTILITY

PART 2 - UNDER 15 MINUTES LONG

1-877-359-3232

OVER 50 YEARS OF KNOWLEDGE

**CHRONIC FATIGUE
AND ENERGY**

→ *Part 2*

1-844-210-2184

Under 15 minutes long!

**SLEEP
SCIENCE**

HOW TO SLEEP
BETTER-
NATURALLY! z z z



8 hours

UNDER 15 MINUTES LONG

1-833-353-5202



1-(833)
679-
7474

**LYME
DISEASE**

UNDER 15 MINUTES LONG *Part 2*



Dr. James Martin (DCCM, DACBN, BCAC, FPAW, FPCP)

*Celebrating
50 Years
of Natural
Health!*

We're thrilled to introduce our all-new lineup of natural health teleseminars! Backed by 50 years of experience, these new teleseminars are packed with valuable insights—and best of all, they're completely free. Don't worry! If you did not listen to Part 1, you can still learn exclusive information and learn all about the topics listed above. You can tune in whenever it suits you—day or night—throughout the entire month.

As a special thank-you for joining us, listen all the way through and leave us a voicemail with your name and address at the end to receive a free gift worth over \$20! Don't miss out on FREE information that can change your life!

Disclaimer: This is for educational purposes only. We do not claim to treat, cure, diagnose, or prevent disease. These statements have not been evaluated by the Food and Drug Administration.

HEALTH/HOME

INTRODUCING Krave ZERO

- No Dairy
- GLP-1 Support
- Formulated and made in Georgia

- ZERO** - Sugar problems
ZERO - appetite
ZERO - calorie's
ZERO - cravings
ZERO - caffeine
ZERO - crash
ZERO - side effects
- Are you overweight?
 Are your sugars imbalanced?
 Do you struggle with gut health?
 Do you struggle with liver problems?
 How is your pancreas?
 Do you have inflammation?

THE NATURAL WAY
 GLP-1 for
 weight loss

*Brighter days are ahead of you.
 Try our Krave Zero, a new way to lose weight!*

Supplement Facts
 Serving Size: 2 Capsules
 Amount Per Serving: 134 mg
 % Daily Value
 Krave Zero Complex (Berberine HCl, and Dihydroberberine HCl), Psyllium Husk Extract (Emmetia inermis), Apple Pectin Extract, Chromium Chloride hexahydrate, Manganese (as Manganese 200) (Complex containing 100 000 Krave and patented 4000 Grams) Guar Gum Powder.
 Other Ingredients: Vegetable Capsule (Inulin), Brown Rice, Silica, Magnesium Stearate.
 Psyllium™ is a trademark of Widge Herbs Inc.
 **Daily Value not established.
 †The potency of *Alkermesia macgregoriae* at the time of manufacture.



Retail \$160 AutoShip \$120

This will help:
 Leaky gut
 Inflammation
 Obesity
 Blood sugar
 Pancreas
 Digestion
 Weight loss
 Liver
 Bacterias
 Cravings
 Great Probiotic



Testimonies

- I take 2 in the morning of Krave Zero. I feel great all day with no hunger at all. Plus my sugar levels are great! — Joe, KY
- The pounds keep coming off! — IN
- I lost 4 pounds in only 1 week! — PA
- My sugar dropped from 320 to 160.
- Takes cravings away -
- I can breathe better! — Emma - PA
- Since being on KRAVE Zero I've noticed less indigestion & no more heartburn! Just better all around! — B Miller

If nothing else works,
THIS WILL WORK!

TO ORDER CALL
260-593-0964
Ferman & Karen Hochstetler
 3215 S 700 W
 Topeka, IN 46571



VISTA VIBE

- Better sleep
- Increased Focus
- Less Anxiety & Depression

7 Adaptogens - Protects cells and organs from toxins and stress, which helps restore cells and organ function.
7 Strong Antioxidant Berry Complex - Has some of the highest antioxidant levels of any food that support your immune system and decrease your risk of sickness.
7 Major Juices and Extracts - Assists the body in attaining vibrant health, well being and longevity. It has been shown to assist in neutralizing free radical damage.
32 oz. Retail: \$58 Auto-ship \$35



Prosta Flow™

supports prostate health and alleviate common symptoms associated with prostate enlargement.
 Retail: \$38
 Auto-ship \$24



Keep VIRUSES Away Immune 5

BENEFITS:
 ✓ Shortens life of viral illness
 ✓ Lowers the body's viral load
 ✓ Helps open breathing passages
 ✓ Generally helps you feel better
 Retail: \$39 Auto-ship \$25



Graviola

Helps eliminate harmful cells without harming healthy ones
 • Antibacterial
 • Digestive health
 • Anti-inflammatory
 • Powerful antioxidant
 • Immune System Support
 Retail: \$38
 Auto-ship \$24



THYROID COMPLEX

7 HERBS AND 7 VITAMINS AND MINERALS
If you suffer from: Loss of appetite, being overweight, fatigue, muscle weakness, dry skin, depression, hair loss, constipation or reoccurring infection **Thyroid Complex could HELP!**
 Retail: \$36
 Auto-ship \$22

KEY Ingredients:
 Vitamin B12, Selenium, Iodine (From kelp), Zinc, Ashwagandha Root, Cayenne Pepper, Bladderwrack, Manganese, Copper

These statements have not been evaluated by the FDA and are not intended to diagnose, treat, cure or prevent any disease.

THE WATER SOLUTION™

>>> Upgraded More Powerful...

An Extra Ordinary Structuring Unit



Requires NO Electricity

...Stainless Steel Unit <<<

Makes City & Well Water Healthier for You Than any Filter Will

The WATER SOLUTION Does so Much More Than Just Restructuring Your Water

It micro-clusters/re-structures water (makes water very hydrating for your body), neutralizes toxins, eliminates pathogenic bacteria, clears toxic frequencies in water, & energizes water with powerful healing frequencies.

What people are saying about THE WATER SOLUTION:

- ▶ Better Energy & Mental Performance
- ▶ Better Overall Health & Body pH
- ▶ Better Digestion, Kidney, & Bowel Function
- ▶ Joint Pains Go Away
- ▶ Water Tastes Better and Feels Softer
- ▶ Drink More Water Without Feeling Bloating
- ▶ Plants Do Much Better
- ▶ Better Milk Production in Dairy Cows & Goats
- ▶ Better Egg Production in Chickens & Ducks
- ▶ Hard Mineral Deposits Dissolve and Are Prevented in Water Heaters & Boilers
- ▶ Detergents Suds and Clean Better

ONE YEAR MONEY-BACK SATISFACTION GUARANTEE & LIFETIME WARRANTY

Stainless Steel Unit: For 1/2", 3/4", & 1" Water Lines \$1695.00 & Free Shipping
 Stainless Steel Commercial Unit for 1 1/4", 1 1/2", & 2" Waterlines: \$2595.00 & Free Shipping

Glen Lehman

22423 NW County Road 1493
 Alachua, Florida 32615

Phone: 260-350-1054
 Email: watersolutionunit@gmail.com

Sciatica That Just Won't Go Away?

If You've Tried Everything and Still Hurt — Read This Before You Waste More Time, Money, or Hope

Many people suffering from chronic sciatica have a **hidden spinal disc injury** that was never properly diagnosed.

If your pain keeps coming back no matter what you try, this is likely why.

That's why pills, injections, therapy, and stretching often fail—they treat symptoms, not the disc itself.

Our clinic is different. We use a **diagnosis-first, non-surgical approach focused only on spinal discs**. Not knees. Not hormones. Not general pain care. **Discs only.**

We've helped Amish, Mennonite, and English patients from across the country finally understand what's wrong—and what it will take to fix it, without surgery.

CALL TO LISTEN 24/7



Free recorded lecture

1-260-412-0351

TOPIC: “The Real Cause of Sciatica Most Doctors Miss”

Midwest Disc Clinic

📍 2180N 700W Shipshewana, IN 46565

🌐 www.DrJeffGarofalo.com

☎ 260-535-0993

Informational only; not medical advice. Individual situations vary.

HEALTH/HOME



CAPSULES: Same great product, better value. Each capsule is equivalent in active ingredients to 2 fluid ounces of our 99.7% Aloe Vera Leaf Juice. Shape and small size for easy swallowing.

4X CONCENTRATE: One quart of our Extra- Strength Aloe Vera Juice is equivalent, in active ingredients, to a gallon of our original Aloe Vera Leaf Juice.

SHAMPOO & CONDITIONER: Shampoo made with 50% Aloe Vera Juice, Conditioner made with 60% Aloe Vera Juice. Designed using only high quality, non-toxic ingredients beginning with the purest Aloe Vera.

ALOE VERA GEL: To be used topically on your entire body. Designed using only high quality, non-toxic ingredients beginning with the purest Aloe Vera. When used topically it supports the healing of skin tissue, helps itching and soothes insect bites.

PET CRUMBLES
 Glucosamine - Joint Health
 Aloe Vera - Digestive Support
 Probiotics - Gut Health and Beneficial for the Immune System
 Yucca Schidigera - Skin and Coat Health

HORSE PELLETS: Pharm-Aloe Horse Pellets support a horses GI health, immune system, aids the balancing of stomach pH, supports normal detoxification and normal inflammatory response processes and reinforces cellular communication.

ALOE GUT: 97% Aloe Vera Gel that helps with colic conditions, GI health, comfort support and recovery support.



AVAILABLE AT MOST LOCAL BULK AND HEALTH FOOD STORES

ITEM NO.	QUANTITY	UNIT	DESCRIPTION
PA114		90 Capsules	Pharm-Aloe® Aloe Vera Leaf Juice Capsules
PAG8		8oz	Pharm-Aloe® 98% Aloe Vera Leaf Juice Gel
PAC32		32oz (1-QT)	Pharm-Aloe® AVL Juice 4X CONCENTRATE
EA25		25-LBS	Pharm-Aloe® Aloe Vera Leaf Horse Pellets
PAT60		14 oz.	Pharm-Aloe® K-9 Aloe Treats
PASH12		12 oz.	Pharm-Aloe® Aloe Shampoo
PACN12		12 oz.	Pharm-Aloe® Aloe Conditioner
EAG60		4 Pack	Pharm-Aloe® AloeGut

To place an order contact your Michiana Distributor

Michiana Aloe Sales
 Attn: Ervin & Rosemary Mast
 32251 Hagelgans Road
 Burr Oak, MI 49030
269-503-0014



Bi-Monthly Magazine

Featured Content:

- Community to community, what works best
- Health coach views
- Fellow people sharing to others.
- Specific health topics from home to home.
- Garden to table ideas
- Soil to harvest

For articles and advertising contact: Phone: 330-204-9199 Fax: 877-822-8390 Email: sales@anabaptisthealth.com

The Anabaptist Health Journal 2025 Subscription Form

Name: _____
 Address: _____
 Phone: _____ Fax: _____
 Email: _____ Signature: _____

Subscription:

USA:
\$39.99 1 year
\$78.00 2 years

Canadian:
\$69.99 1 year
\$138.00 2 years

Bi-Monthly Magazine:
 6 Issues Per Year

Your subscription will automatically renew with the payment method provided unless you cancel it.

PAYMENT INFO: INV # (office use only): _____
 Check# _____ AMT: _____
 Type of card: American Express Visa MasterCard Discover
 Credit Card#: _____
 Name (as it appears on the card): _____
 EXP: _____ CVC CODE (on back): _____
 Phone #: _____ (required for credit card use)

Mail this form and payment to:

The Anabaptist Health Journal
 PO Box 3
 Charm, OH 44617

Call 330-204-9199 with credit card information

email this form to: sales@anabaptisthealth.com

HEALTH/HOME

Micro Daily ~ The Micro Nutrients ~ Human Health ~ Engage Global



DR Kedar Prasad has awarded 10 US patents for using Micronutrients (Micro Daily) as a defense to protect our cells and DNA against chemicals and EMF Radiation (5G) 30 plus years director of vitamins & cancer research, discovered the anticancer potency of vitamin E succinate

Need help with?
Heart & Brain function
Headaches & Dizziness
Gut issues & Hormones
Seizures & Anxiety
Heavy Metals & Fatigue
 Lymes & Thyroid, Hip & Knee pain
 Inflammation, Parkinsons & more

Boost products Huge savings on a bundle!
 Plus, up to a \$20.00 discount per bottle on boost products, when purchasing a bundle
 Heart ~ Brain ~ Digestive ~ Sleep ~ Eye ~ GLP ~ Menopause ~ Mens-T



Great Testimonies On childrens Gummies for Focus, Hearing, Autism Organ health & Bone development



Basic Bundle
 Micro Daily Probiotic
\$9.00 savings

Premium Bundle
 Micro Daily probiotic Omega
\$23.00 savings

Core 4 bundle with GLP \$57.00 savings
core 4 bundle \$38.00 savings

NEW! For weight loss & hormones

Engage Global (Health Products)
Christ Fisher 717-355-5577

Call for a number to listen to testimonies On most health issue
 Micro Daily is indeed the worlds most scientifically validated nutrition

Patents on
Diabetes, Tinnitus, Pulmonary Heart Health, & more

These statements have not been evaluated by the FDA. This product is not intended to diagnose, treat, cure, or prevent any disease

"How I Healed The Herniated Disc In My Back, Re-Gained ALL My Strength... and More!"

Find Out What A Natural Doctor Did To Fix His OWN Disc Problem

From the Desk of Dr. Russ Schroder, DC, DACNB, FACFN, Board Certified Chiropractic Neurologist.

Three years ago I injured my lower back when I herniated a disc lifting heavy weights.

It was a terrifying experience that I had never been through before.

In an instant, my back gave out with almost 200 lbs. on my shoulders, and I heard a very loud SNAP.

The shock was immediate- like being stabbed by a knife!

I was able to get an MRI the next day and found out I had injured the lowest disc (cushion) in my back.

The CTX Method

Fortunately, the MRI showed the exact type of problems we have helped with our CTX Methotechnologies since 2006. The torn disc had herniated/ protruded out of its normal shape, bulging out into the nerve space.

I could barely stand upright the first week, but I pushed through our Avoid Back Surgery Program for a month. I got out of pain and then continued healing by taking it easy during exercise for just a few extra weeks.

So, after getting the disc healed and taking those weeks to slowly start working out again, I gradually built up my strength again and have gone on to lift MORE than I used to 20 years ago!

Many Still Suffer Unnecessarily

Many of you reading this are living with that severe pain in your lower back (and maybe in the nerves down your legs). Others have disc problems in the neck that can affect the nerves in your arms.

For some, it is so bad you aren't sure what the next step is.

It can be very scary... especially when it's a pain that isn't going away.

Maybe you tried chiropractic or massage. Maybe you've popped some pain pills or herbs.

For many, this low back pain (especially disc pain) can mean a lifetime of bouncing from chiropractor to doctor to physical therapist to surgeon after surgeon. It can mean a lifetime of shots, pain pills and more suffering.

Maybe you've tried an inversion table, traction or "decompression" (the kind where you sit on the table and then lay down to get stretched).

But the thousands who have come to us for our CTX Method (from all-across America and Canada) have already tried some of these and failed to get relief.

We've even helped other doctors with our CTX therapies including chiropractors, medical surgeons, osteopaths, psychologists and podiatrists who have avoided surgery and referred in numerous others.

This Month's Offer

It's winter, and our Avoid Back (and Neck) Surgery Program starts to fill up fast at our 4 offices. But if you call this month, we are offering a FREE exam (A \$250 Value) and a FREE Trial of our CTX Method for those who have disc injuries like bulged, herniated or protruding discs OR spinal degeneration/ spinal arthritis.

So please call one of our offices to see if you qualify for a consultation before spaces run out and you get put on a waiting list and pay full price.

Or to receive our AVOID Back & Neck Surgery Report, call an office and our staff will mail you out a free copy. (A \$29 value) Supplies are limited.



HEALTH/HOME

PLEASE CALL US

as soon as possible to get scheduled, and we will mail out our Avoiding Back Surgery Report before your 1st visit.

Happy New Year! We look forward to helping you in the coming months!



Dr. Russ Schroder,
DC, DACNB, FACFN
Chiropractic Neurologist



Dr. Heather Schroder
Naturopath

PROFESSIONAL WELLNESS ALLIANCE PROVIDER

Pain or Inflammation?

UNABLE TO FIND FACTOR 5?

Try Relief Pro Max!

NEW LOWER Pricing

Wholesale Inquiries Welcome

- Turmeric
- CBD
- Anti-inflammatory ingredients

- Free shipping on all orders
- Money-Back Satisfaction Guaranteed
- Also available without CBD
- Stay tuned for a new & more powerful formula coming soon



Everspring
wellness

4430 Township Road 447
Sugar Creek, OH 44681
1.330.600.1428

Did you know that 80% of your health starts in your gut?



And did you know that 90% of your 'feel-good' neurotransmitters, like dopamine and serotonin, are produced in your gut?

That's why Amare Happy Juice was created.

Happy Juice is a delicious drink packed with probiotics, prebiotics, phytochemicals, and nootropics, designed to push the bad bacteria out of your gut and naturally stimulate the vagus nerve.

Benefits of Happy Juice

- Supports mood, motivation, cognitive performance, attention, and memory.
- Promotes serotonin, dopamine, and GABA production.
- Supports normal cortisol levels and stress resilience.
- Repairs the gut lining.
- Calms anxious energy and sharpens mental clarity.
- Balanced hormones (progesterone, testosterone, estrogen and more.)
- Supports gut health = better mood, focus, and digestion. Helps with gas, bloating, or constipation.
- Repopulate the gut with good bacteria while flushing out the bad.
- Clean plant based ingredients .
- Safe during pregnancy and breastfeeding.
- Simple. Powerful. Backed by science. Third party tested.

There's even a kids version!

Combined with kids mood+ and kids calm =

- Emotional regulation+ fewer meltdowns & tantrums.
- Natural calm for overwhelmed, anxious, or overstimulated kids.
- Promotes motivation, focus, and concentration.
- Supports stress resilience, digestion, and maintains a happy healthy gut
- Helps immune and circulatory systems.
- Relaxation and calmness for higher-quality restful sleep.
- Sugar free, stimulant free, and great taste!
- Help your kids be at their best performance this school term.



TO LEARN MORE PLEASE CONTACT

Barbie Zook
3614 Wilcox Rd.
Seymour Falls, WI 53180
440-321-0906

Get \$10 off your first order!

Plus we offer a 90 day money back guarantee!

these statements have not been evaluated by the FDA, we do not claim to treat, diagnose, cure or prevent disease

HEALTH/HOME



ORTMAN
CHIROPRACTIC CLINIC

Call (605)296-3431
to schedule your
appointment today!

Canistota, SD
www.ortmanclinic.com

Helping people
**FEEL BETTER
MOVE BETTER
LIVE BETTER**
for over 110 years



Start your day off right



Zeolite is a volcanic ash that forms over time when ash and lava react with alkalized water in a non-contaminated environment. Resulting in a compound with a very strong, cage-like structure that pulls toxins out of your body instead of pushes.

- Promotes Detoxification
- Supports Digestive Health
- Boosts Immune System
- May Help Reduce Radiation



\$19.50
30 Day Supply

A Powerful, All Natural, Toxin, Heavy Metal

ELIMINATOR



Epic Zeo Heal is a product that is formulated with the fastest and best healing protocols in mind. Zeolite has been used for years in the military to help stop bleeding



\$14.75

- Aloe Vera, Colloidal Silver, Comfrey and Burdock leafare used as an antibacterial and healing agent.
- Honeycomb and beeswax help with the regrowth of flesh and skin.
- Hemp oil keeps the pain level in check.

CBD Roll On Muscle Gel

For soreness, stiffness, or swelling.
1800 mg **\$55.00**

CBD Gummies

Simplify your daily CBD routine.
900 mg **\$40.00**

CBD Gel Caps

Designed for optimal absorption.
300 mg **\$20.00**
900 mg **\$35.00**

CBD Tincture

Bring balance and harmony to your day!
300 mg **\$20.00**
900 mg **\$35.00**
1800 mg **\$65.00**

CBD Hand & Body Cream

Creamy, rich and soothing.
300 mg **\$30.00**

Ask for Key Organics at your local health and bulk food stores



Moving CBD out of the past . . .
Into the future.



FULL SPECTRUM

Distributed by:



717-715-3498
332 Hollow Road
Quarryville, PA 17566

Dealer inquiries welcome.
Call for wholesale pricing.

HEALTH/HOME



Worms & Parasites.

Reader stories are not scientific evidence. What works for one person, may not work for the next.

No medical proof. Folklore.

If you have health problems that won't go away, it's time to give this Formula a try.

Important. If you eat Pork, Ham or Bacon -- 100% certain you need this formula!

100% Natural

TOP Seller!

Powerful Formula

This is a Miracle!

"Finally I feel human again. This formula transformed my life. My vigor, vitality & clarity returned."

SPEICHER'S Worm & Parasite Formula



Animal Speicher

Reader stories are not scientific evidence. What works for one person, may not work for the next.

What a difference! In just 13 days, I feel less bloated & have more energy.

Aids in Removing Worms & Parasites.

No medical proof.

No guarantees but certainly worth a try.

"Everyone, rich, poor, the whole population has parasites."

- Dr. William Kelley

"Everyone has parasites - everyone! I mean 100% out of 100 people."

- Colon Therapist.

"The People who are the Sickest -- they have the most parasites."

- Healer.

"Parasites can remain in your body for 10, 20 and even 30 years."

- Medical Research.

100% Folklore. Zero Science.

Could THIS be the reason you can't get well?

"Everyone, rich, poor, the whole population has parasites."

- Dr. William Kelley

"Everyone has parasites - everyone! I mean 100% out of 100 people."

- Colon Therapist.

"The People who are the Sickest -- they have the most parasites."

- Healer.

"Parasites can remain in your body for 10, 20 and even 30 years."

- Medical Research.

100% Folklore. Zero Science.

If you live - or work near Pets & Farm Animals, chances are... YOU have Parasites! Or Worms. Or both!



Horses, Cows, Pigs, Dogs, Cats

Pet Birds are often the worse because they flap their wings. This can spread parasites all over the house.

- Which worm or parasite do You have?
- Roundworm in Skin → Eczema
 - Ascaris Worm in Lung → Asthma
 - Fluke in Pancreas → Diabetes
 - Thread Worm → Migraines

Worms are often invisible to the Human Eye.

Severe Bloat, gone!

A man had severe bloat & constipation. He was always hungry, no matter how much he ate.

His stool sample tested positive for parasites. The Speicher Worm Pills ended most of the problems.

Itchy back-end.

"My back end was itchy. After only 4 days, that vanished."

Skin now Rosy.

"My skin is now a healthy pink. It glows. The worms are gone."

EYES. When the worms go, the eyes start to sparkle.

New Instructions.

Worm & Parasite Formula. (Adults)

Dose: 2 capsules, 3 x a day, during or after meal for 21 days. Off for 14 days. Repeat for 21 days. Use common sense. We will need three bottles for complete cleanse.

A Great Story: A reader noticed he got an upset stomach a few times on the formula. When he finished the program, the stomach aches stopped. He feels this was due to the worms dying & being expelled.

No guarantees but certainly worth a try.

Key ingredients - Mugwort, Arterisia, Hyssop & 5 more natural ingredients.

Note: Not for pregnant or nursing mothers.

Helps to Expel Worms & Parasites. The sooner these Hungry Pests leave your system, the better you'll LOOK & FEEL!

Speicher's Health Products.

#1. Worm & Parasite Formula

One bottle, 100 capsules. \$29.95 & \$4 P&H.

No guarantees but certainly worth a try.

#2. Three bottles. (Save \$16.) \$73.95 & \$5 P&H.

#3. Six bottles. (Save \$47.) \$135 & \$5 P&H.

*Sales Tax. (VA only, add 5%)

Amazing! I started using this last week -- and am absolutely AMAZED! Never felt better.

No guarantees but certainly worth a try. All health claims are medically unproven.

No medical proof. Folklore.

Speicher's Health Products
2761 Greenway Court.
Harrisonburg, VA 22802
Phone: 800-434-4628
SpeicherHealthProducts.com

Open all Federal Holidays.

Serving among the Amish for over 15 years.



Gott segne Dich!

"And the Truth shall set you Free."
- John 8:32

"Finally, there's Hope!"
- Paradise, PA

Over 1.5 billion people in the world have intestinal roundworms!

Problems often caused by Worms & Parasites.

Fatigue. Allergies. Asthma. Gas. Bloat. Depression. Headaches. Bad Gums. Teeth Grinding. Hyperactivity. Bad memory. Chronic fatigue. Skin Problems. Poor Appetite.

Dizziness. Irritability. Brain Fog. Anger. Weight gain. Itchy anus. Nervousness. Fatty tumors. Diarrhea. Constipation. Back Pain. Poor Sleep. Cancer. Bad Vision.

An Amish Farmer took this Formula for 2 weeks. He was stunned to see white worms and eggs in the toilet.

These problems could also be caused by other conditions.

Worms outrank Cancer as Man's Deadliest Enemy.

No medical proof.

Many incurable diseases are worm-based.

Vision improved.

One woman was seeing rainbows when the sun shined. When she removed the parasites from her body, her vision was normal.

Parasites & Cancer?

Millions have this parasite, the intestinal fluke. One health author claims that all cancers are caused by a single parasite -- the intestinal fluke.

Popular Books & TV shows.

- #1. Monsters INSIDE Me. (TV)
 - #2. Guess Who came to Dinner?
 - #3. Every BODY has Parasites.
- Amazing! I started using this last week -- and am absolutely AMAZED! Never felt better.

Pets? Check with your Vet

Reader stories are not scientific evidence. What works for one person, may not work for the next.

New Instructions.

Worm & Parasite Formula. (Adults)

Dose: 2 capsules, 3 x a day, during or after meal for 21 days. Off for 14 days. Repeat for 21 days. Use common sense. We will need three bottles for complete cleanse.

Dear Friend.

100% Folklore. Zero Science.

If you have a health problem -- and can't get well, there could be a very good reason. Worms and parasites!

It sounds hard to believe, I agree. But if you're alive and breathing -- you're at risk. You may not see these tiny creatures. But believe me -- they're there! While you sleep, they eat. Your food! Your nutrients!

Pet owners often have red worms.

Many eat the best natural foods and take the best supplements -- and never get well. Why is that? One reason is the worms and parasites take the best nutrients. YOU get the scraps -- the leftovers!

It's TIME to Clean House! Get rid of unwanted guests!

It's time to kick these suckers OUT -- once and for all. Out out. OUT! No more Free Lunch!

One Woman's Secret. She is 101.

A woman in New Mexico is 101 years old. Her mind is razor sharp. Her memory is great. She works eight hours a day. Her secret? She keeps her body free of parasites & worms.

Did you know that microscopic parasites can cause arthritis?

Sensitive issue stopped.

A young daughter was constantly scratching her butt. Her mother found tiny, white worms in that area. They crawled out at night. Creepy! She took the Speicher Worm Pills. The itching stopped.

Four ways you can get Worms & Parasites.

1. Unwashed fruits and vegetables.
2. Unwashed watercress from streams.
3. Raw-undercooked fish.
4. Pork. Try to cook all pork products at the highest possible temperature.

The Colon & Parasites.

A lot of worms & parasites flourish in the colon. That's why, keeping the colon clean is critical. Ask for Speicher's Colon Pills.

Note: All health claims are medically unproven. Before you take any natural remedy, always check with your doctor.

1. No section may be copied, printed or used electronically without the express written permission of Loren N. Biser.
2. All rights reserved. Copyright © 2014, by Loren N. Biser.
3. After Everything FAILS is a registered trademark of Loren N. Biser.
4. Speicher is a registered trademark of Speicher Health Products.

All health claims are medically unproven. 100% Folklore. Zero Science.



HEALTH/HOME

What will you discover in your cup?



It's good!

Rosie's Roost

Premium Organic Coffee



patience



COURAGE



Roasted to order for optimum flavor and freshness!

Coffee worth crowing about!

Name _____

Address _____

Phone# _____

\$18.00 per 12 oz. bag Ground Whole Bean

1-5 12 oz. bags \$6.00 shipping

6 or more bags FREE shipping

Quantity _____

Amount \$ _____

Shipping \$ _____

Total \$ _____

Please Make payment to: Rosie's Roost
Mail coffee orders to: P.O. Box 86, Argyle, WI 53504

Shipping only to the continental US.



COLOMBIAN
Medium Roast

HEALTH/HOME

Don't waste your time shopping for something that's not there!

Call us at 330.331.2035 to order items online.



We'll shop online for you and have the goods delivered directly to your door. (no shoes, clothing or refrigerated food*)

Monday - Thursday 8:00 am - 3:30 pm.
Friday 8:00 am - 2:00 pm EST Closed Sat. & Sun.
*Limitations and convenience charges apply.

#1 Bestseller on **amazon**

Order While Supplies Last

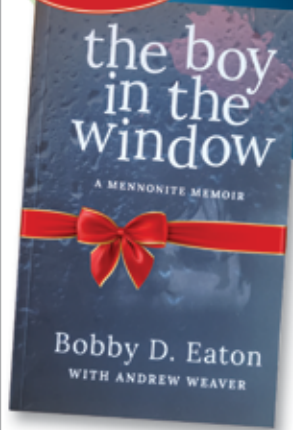

the boy in the window

Growing up as a Ragland boy meant a one-way street to nowhere-until the Mennonites moved to town.

Order Form

Name _____
Address _____
City _____
State _____ Zip _____
Phone _____

Price for 1-19 books is \$19.99 each, free shipping
Price for 20+ books is \$11.95 each, free shipping

Qty Books _____ Total \$ _____

Mail form to: Pure Path, P.O. 151 Box Emmitsburg MD 21727 Or call 888-401-7747 to place your order.

Pure Path, P.O. 151 Box Emmitsburg MD 21727 • 888-401-7747

Make your *Someone Special* feel **Healthy & Happy** with a **Silicone Bowl**

- February Special -
\$31 - 4 piece set **get a 6 oz bowl Free.**
\$8 Shipping (Offer Ends Feb 28)



Perfect for Lunch Boxes or Leftovers

- Collapsible, stores easily
- Lids fit tight, no leaking
- Withstands extreme temperatures up to 300 degrees
- Reduce plastic use
- Silicone is the healthier choice



Contact - 56865 CR 2 Fresno, OH 43824 | 330 440 3395

HEALTH/HOME

NOTICE

WE ARE DROPPING OUR SHIPPING PRICES

FREE!

PREPAID ORDERS
\$150.+ NOW SHIP FOR
\$0 TO IN. RESIDENTS*



Order Your Free
100+ Page
Catalog Today



Signature BOOT & LEATHER CO. (330) 695-9977

*Some Exclusions Apply, Call Our Number For More Details

Cedar Lane
Dry Goods and Quilts Inc.

- Books
- Quilts
- Musical Clocks
- Baby Items
- Sweaters
- Dress Fabrics
- Quilt Fabrics
- Sewing Supplies
- School Supplies
- Toys and much more...

Quilt Tops
Choose from our 100's of Quilt Tops... Or create YOUR OWN UNIQUE QUILT using just some of our patterns shown in this ad!

We'll ship Quilts and Fabrics to you... Ask us about it!

Mon. - Thur. 8:00am to 5:00pm
Fri. 8:00am to 8:00pm
Sat. 8:00am to 4:00pm

Latest Spring Fabrics in stock!

Treat yourself with a new quilt!
They also make memorable gifts!

Get the latest fabrics from our inventory for your QUILT PATTERN(S) and for all your SPRING SEWING PROJECTS!

Great source for Quilt Clubs and Church Quilting Groups!

We stock assorted color rolls and bolts of Polar Fleece. Starting at \$3.99 a yard.

204 Orlan Rd.
New Holland, PA 17557
717-354-0030

Receive quarterly dress fabric samples. Get added to our list by mailing \$45 annually along with your full name, address and phone number.

Request a Catalog
Mail Cedar Lane your full name, address, and phone number.

STOJO Silicone Collapsible Food Storage Bowls

Making the Kitchen
a Better Place
With Less Plastics.

Finally a BPA Free Bowl for Food
Double Strength Durability
Collapsible for Small Space Storage
Freezer/Fridge/Ice Box Friendly
Perfect Bowl for Lunch Box
Liquid Tight



Now I have peace of mind.
Good Bye Plastics

To Order Call 330-440-3395
James & Sarah Beechy
56865 CR 2
Fresno OH 43824

HEALTH/HOME

The Henson Shaver with Stainless Steel Blades



AL 13 Black \$109



AL 13 Copper color \$109

Cost of Shaving for 3 Years

(in USD)

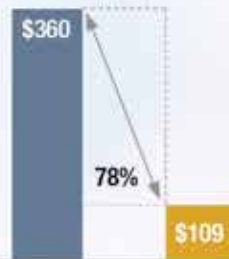

Disposable \$10/month Henson AL13 AL 13 razor + 100 blades

Save Plus Keep this world a cleaner place by using a shaver that has no plastic disposables.



100 Free Blades with Purchase of Shaver.



Perfect gift for Employees, Husbands, Special Friends



Over 10,000 Five Star reviews from satisfied people that are using the Henson Shaver.

David Yoder

1550 CR 160, Dundee OH 44624

Name _____
 Address _____
 City St, Zip _____
 Phone _____
 Item # AL13 Qty _____ Color _____ Price _____
 Shipping for 1 Shaver...(USA order) \$10.00
 OH residents add 7% sales tax
 Total

To Order Call 330-600-8529 or Mail This Form

HEALTH/HOME

**The peeler that peels,
Pears, Peaches,
Oranges, Kiwis,
Apples, Potatoes!**

*Great
Valentine's
Day
Gift*



**Price \$198.25
+ \$10 Shipping**
(OH residents add 7% sales tax)

**Call 330-390-2992
The Blooming Thistle**

31527 Township Road 227, Fresno OH 43824

HEALTH/HOME

Betzi's Tips and Tasties!



HEALTH/HOME

Quick-N-Easy Ice Cream

Ingredients:

- 1½ c. sugar
- ½ c. instant clear jel
- ½ c. instant vanilla pudding
- 1 tsp. salt
- 1 tbsp. vanilla (opt)
- 3 qt. milk

ENJOY!

Directions:

- Mix dry ingredients together
- Using a blender, mix 1 quart of milk with ½ dry ingredients and 1 tsp. of vanilla
- Repeat this with the remaining milk
- Freeze in 6 quart ice cream freezer
- * For mint chip, replace vanilla with mint flavoring.
- For strawberry, replace 3 cups of milk with strawberries
- * If eating ice cream right away, you do NOT need to pasteurize milk if using raw milk.

Recipe shared by: Rosalie & Bethany Beery

Have any tasty recipes or tips you would like to share? Send them to
 Betzi / Busy Beaver Publications • 61362 CR 43 • Goshen, IN 46528
 Want Betzi to feature your Business? For more information please call 574-501-5105

S·V·F

Stop in & check out our store while in town for the Airworks Auction

Located only 1 1/2 miles from Airwork's main store & 7 miles north of Auction Grounds.



Home Décor
From Signs, Canvases,
Precious Melodies Clocks to Greenery.
Let us help make your home inviting



Full line of Housewares:
All the way from a Spatula to
Harvest Right Freeze Dryers.
Stop in & Check it Out.



Sirena Sweepers, Wall Mops,
Vertex & Pinnacle Mop Buckets.
All to make your Cleaning a Breeze



Full Line of Clothing for the Plain Communities.
From Men's & Ladies coats,
Insulated Bibs, Sweaters,
Mutza to Wool Hats we have you Covered.



We not only Offer an Excellent Selection
of Fabrics, but also Provide all the
Sewing Notions you need to
Accompany Them.



Hundreds of Bolts of Fabrics,
Suitings & Denims



WE CARRY HUNDREDS OF BOLTS OF FABRICS, A FULL LINE OF CLOTHING FOR THE PLAIN COMMUNITIES. WOOL & STRAW HATS, MULTIPLE LINES OF BABY ITEMS, INDOOR & OUTDOOR GAMES, HOUSEWARES, BOOKS, BIBLES, VITAMINS, INCLUDING CHUPP'S HERBS, NATURAL HOPE HERBALS, & KRAUSE. HOME DECOR AND SO MUCH MORE...

9257 E MORELAND RD, APPLE CREEK OH 44606
P 330-698-0225 F 330-698-0139
M-F 8:5 SAT 8:2:30
summitvalleyfabrics@gmail.com

HEALTH/HOME

Safe Silicone Wrap For Food

Helping what matters....Make This world a better place with no plastics.







Wrap

Feel Good

Wash

Reuse

Feel Good About Reusing Wrap Again.

**BPA Free (no toxins)
Freezer Friendly
Lunch Box Friendly**

To Order Call  330-440-3395

HEALTH/HOME

Pine Hollow Footwear



**Call for a free catalog!
610-663-0400**

Propet Skechers FootSteps
Eastland Nunn Bush SBS
Joybees Nuusol

Pine Hollow Footwear
348 East Vine Street Fleetwood, PA 19522



The Wisconsin Shopper

Established 2015

MAIL ADS, INQUIRIES, AND SUBSCRIPTIONS TO: THE WISCONSIN SHOPPER

The Wisconsin Shopper is an advertising paper published weekly and mailed free to the horse & buggy groups—approx. 6500 Amish and 600 Mennonite homes—every week! New Subscriptions of \$50 per year are available to Amish outside of Wisconsin and Minnesota, and to non-Amish. Write for our Ad Rates.

The Wisconsin Shopper

12608 Orr Rd., Fennimore, WI 53809

HEALTH/HOME

White-Backpack **\$80.00**

CanVas Love **\$59.00**

Utility Tote **\$49.00**

Pouch **\$15.00**

Small Backpack **\$15.00**

School Backpack **\$30.00**

ALSO AVAILABLE IN GRAY

Free shipping on all orders over **\$75.00** or book a party and win Free Bags

More styles and colors available

Nina LaVon
HANDBAGS

Mary Zook
2232 Mountain Rd, Manheim PA 17545
717-859-5824

Enjoy our fridge and freezer storage solutions

<p>Freezer Mates[®] PLUS 16-pc. Set 1566 \$98 \$69 US / \$134 \$89 CA</p>	<p>Freezer Mates[®] PLUS Medium Shallow 1598 \$18 US / \$25 CA</p>	<p>Freezer Mates[®] PLUS Small Deep 1597 \$26 US / \$36 CA</p>	<p>Rectangular Cake Taker Holds up to a 9 x 13"/23 x 33 cm layered cake. Flip the base to hold up to 18 cupcakes or muffins. Includes cover with handle. 81992 \$60 \$35 US / \$80 \$45 CA</p>	<p>Rectangular Cake Taker Holds up to a 9 x 13"/23 x 33 cm layered cake. Flip the base to hold up to 18 cupcakes or muffins. Includes cover with handle. 81993 \$60 \$35 US / \$80 \$45 CA</p>
<p>Freezer Mates[®] PLUS Small Shallows 1596 \$36 US / \$48 CA</p>	<p>FridgeSmart[®] Starter Set 670 \$99 \$89 US / \$126 \$114 CA</p>	<p>FridgeSmart[®] Vertical 664 \$24 \$19 US / \$30 \$26 CA</p>	<p>Round Container Freeze, store, and take 11"/28 cm pies and cakes, or up to 12 muffins on the go. 3 x 12"/7.5 x 30 cm diameter. Includes lid. 81994 \$27 \$15 US / \$36 \$20 CA</p>	<p>Snack-Stor[®] Large Container Family-sized snack keeper with seal, perfect for storing food in the fridge and pantry, or taking on the go. 12 x 9 x 2 1/4"/30 x 23 x 6 cm. 81995 \$29 \$19 US / \$39 \$29 CA</p>

Round Cake Taker
81991
\$48 \$30 US / \$60 \$38 CA

SHIPPING PRICES +TAX

Tupperware[®]

Rena Bickley
Tupperware Consultant
1087 Smith Terrace
Maysville, KY. 41056
606-375-2602

Product totaling:
\$1-\$74.99 Shipping \$9.99 / \$75-\$149.99 Shipping \$13.99
\$150.00-\$249.99 Shipping \$17.99 / \$250 & up Shipping \$19.99



REFRESHMENTS SERVED

KITCHEN & BATH EVENT

FEBRUARY 16 - 20

2026



CS
counter solutions®
 by lumbermen's
10% DISCOUNT*

*ORDER DEADLINE: JUNE 30TH
IF QUOTED BY FEBRUARY 28, 2026



HappyFeet
 INTERNATIONAL
 FLOORING

15% DISCOUNT

PALISADE
Waterproof, Grout-Free Wall Tiles

5% DISCOUNT



Woodward
CABINETRY

15% DISCOUNT



MANTRA
CABINETS

10% DISCOUNT



ORDERS PLACED FROM FEBRUARY 16 - 28 QUALIFY FOR DISCOUNTS

Lead times vary based on product line

SHIPSHEWANA

NAPPANEE

NOTTAWA



📍 0855 N SR 5 Shipshewana, IN 46565
☎️ (260) 768-4410

📍 8270 W 1350 N Nappanee, IN 46550
☎️ (574) 773-7787

📍 26250 M-86 Sturgis, MI 49091
☎️ (269) 467-4800

HEALTH/HOME

ASK FOR THEM...



(must be plugged into a power source for display to be lit full time)



Temperature Forecast... Arrows beside the temperature indicate the direction temperature and humidity are trending, increasing, stable, or decreasing.



5-Day Weather Forecast Station

#4035 | \$59.95

Crucial for planning daily activities and making informed decisions in various sectors. Builds forecast from outdoor sensor, no tower involved. Current day plus 4 more days forecast. Temp. display in C or F. Forecast only with clear icons, no rain or wind gauge.

- 2 AAA + 2 AAA for outdoor sensor
- USB power cord included for back light
- Press Snooze for back light with batteries
- 2 different alarms
- Temperature trending forecast with arrows
- Indoor/Outdoor Temperature, Humidity, Moon Phase, Air Pressure, Date & Time
- 6.5" x 5.75" x 1.5"

How reliable is the weather forecast? This is gathering data from the outdoor sensor based on the barometric pressure and temperature and will not be as accurate as an online forecast but it will still give an idea of whats coming. It can take up to 14 days for the forecast to register the weather conditions.

Having trouble connecting the outdoor sensor to the station? Press and hold the channel button on the station for 3-5 seconds on the channels beginning at 1, then 2, and 3. Allow up to 15 minutes per channel for it to connect.

Changing from C to F in temperature display... Press and hold the Max / Min button on the station for 3-5 seconds to toggle to preferred setting.

Will this work in any area? Yes, this unit is not connected to any tower for data. The clock needs to be set manually and all the information is gathered from the outdoor sensor. Sensor needs to be within 95' from station.



MAYKO PRODUCTS LLC
WHOLESALE DISTRIBUTION | CUSTOM IMPORTING

Phone: 866.432.2385 | Fax: 330.556.4542 | sales@maykoproducts.com

These products are also available from Valtea Variety by calling 330.331.2035.

Valtea charges \$10.00 flat rate shipping fee per order.

Request your free wholesale or mail order catalog available.

MayKo is wholesale only, Valtea is mail order only.

...AT ONE OF YOUR LOCAL RETAILERS

DELAWARE		
E & M Variety	Wyoming	DE
King Tools	Dover	DE
Shady Lane Selections	Dover	DE
IOWA		
Hershberger Country Store	Hazelton	IA
Shady Lane Variety	Bloomfield	IA
ILLINOIS		
Central Lighting	Arthur	IL
Farmstead Fabrics	Arthur	IL
Morning Song Collections	Arcola	IL
Tools Plus	Arthur	IL
INDIANA		
Backwoods What - Not	Millersburg	IN
Burkholder Country Store	Nappanee	IN
Chain O Lakes Country Store	Lagrange	IN
Country Charm Sales	Shipshewana	IN
Country Creations	Goshen	IN
D L Schwartz Dry Goods	South Whitley	IN
Dirt Road Fabric	Middlebury	IN
DL Graber General Hardware	Grabill	IN
Eash Sales	Shipshewana	IN
Fabric Depot	Middlebury	IN
Fish Lake Variety	Lagrange	IN
Grabers Country Store	Spensenville	IN
Heartland Enterprises LLC	Nappanee	IN
Herbs Plus	Middlebury	IN
Homeland Sales	Millersburg	IN
J & L Country Sales	Monroe	IN
Kuntry Nock	Topeka	IN
L & R Footwear	Topeka	IN
Lehmans Variety Store	Lagrange	IN
M & L Appliance & Repair	New Haven	IN
Miller Coleman & Variety	Topeka	IN
Miller Power	Topeka	IN
Millers Country Store	Grabill	IN
Millers Dry Goods	Fountain City	IN
Millers Feed Service	Topeka	IN
Millers Kuntry Variety	Middlebury	IN
Millers Variety Store	Etna Green	IN
Mint City Millworks	Bremen	IN
Orchard Drive Variety	Lagrange	IN
Pine Ridge Variety	Lagrange	IN
Shady Lane Enterprise	Lagrange	IN
Slabach Country Sales	Millersburg	IN
Spring Valley Feed	Lagrange	IN
Straightline Enterprises LLC	Millersburg	IN
Sunset Appliance	Topeka	IN
The Country Barn	Middlebury	IN
Timberview Sales	Topeka	IN
Waglers Variety	Montgomery	IN
Wayne County Hardware LLC	Greens Fork	IN
KANSAS		
Brethren Specialties	Westphalia	KS
KENTUCKY		
Nolin River Hardware	Cub Run	KY
Yoders Engine	Munfordville	KY
MICHIGAN		
Chupps Herbs & Fabrics	Burr Oak	MI
Gold Star Bike Shop	Rodney	MI
Grand Trunk Store	Sheridan	MI
Pioneer General Store	Mio	MI
The Country Pantry	Sheridan	MI
MISSOURI		
Blosser Country Store	Halfway	MO
MONTANA		
Bull Mountain Country Store	Round Up	MT
J & S Variety	Plains	MT

NEW YORK		
Bylers Sales & Service	Clymer	NY
Countryside Jams & Jellies	Panama	NY
Hilltop Fabric & Variety	Clymer	NY
Maple Crest Sales	Penn Yan	NY
Mohawk Valley Ag	Fort Plain	NY
Rockhill Energy Solutions	Panama	NY
Valley View Variety	Dundee	NY
OHIO		
Amish Ridge Bulk Foods	Mt Perry	OH
Backyard Bird Store	Middlefield	OH
Bolt + Bloom Mercantile	Middlefield	OH
Boots & Beyond	Middlefield	OH
Bunker Hill Appliance	Millersburg	OH
Charm Gifts	Charm	OH
Charm Harness & Boot	Charm	OH
Clark Valley Market	Millersburg	OH
Country Home Supply	Applecreek	OH
Country View	Carrollton	OH
Cozy Corners Bookstore	Middlefield	OH
D & S Door Sales	Burton	OH
Der Alte Quilt Shop	Dundee	OH
Dublin Gift Shoppe	Fredericksburg	OH
Erbs Variety Store	Middlefield	OH
Family Fabrics	Fredericksburg	OH
Family Fabrics & Variety	Burton	OH
Fredericksburg Harness & Shoe	Fredericksburg	OH
Golden Values Country Store	New Bedford	OH
Grand Valley Footwear	Orwell	OH
Hillside Hardware & Variety	Fredericksburg	OH
Hilltop Variety	Middlefield	OH
Homestown Merchants	Millersburg	OH
Honeytown Market	Fredericksburg	OH
JB Apparel	Middlefield	OH
Kauffmans Treasures	Orwell	OH
Keim Brothers Country Store	Mt Hope	OH
Maple Lane Furniture & Fabrics	Middlefield	OH
Maysville Country Market	Maysville	OH
Maysville Fabrics	Maysville	OH
Meadowview Fabric & Variety	Salinesville	OH
Millcreek Equipment	Millersburg	OH
Miller Footwear	Sugarcreek	OH
Miller Sales	Applecreek	OH
Mohican Hardware	Darville	OH
Mound Country Store	Fresno	OH
Mt Eaton Variety	Mt Eaton	OH
Mulletts Harness Shop	Middlefield	OH
New Bedford Variety	New Bedford	OH
North Fork Variety	Dalton	OH
North Market Variety	Berlin	OH
Old School Fabric & More	Garrettsville	OH
Olde Town Fabrics	Huntsburg	OH
Plain Variety	Applecreek	OH
Pleasant Hill Bulk Food	Fredericksburg	OH
Rabers Harness & Supply	Millersburg	OH
Rubys Country Store	Dundee	OH
Schlabach Country Store	Fredericktown	OH
State Road Battery & Fabrics	Middlefield	OH
Stoltzfus Footwear & Variety	Middlefield	OH
Summit Valley Fabrics	Applecreek	OH
Sunset Variety	Fredericksburg	OH
The Bargain Bin	Middlefield	OH
The Family Shoe Co	Middlefield	OH
Time & Optics	Millersburg	OH
Townline Fabrics	Middlefield	OH
Valley View	Middlefield	OH
West Farmington Fabric	West Farmington	OH
Windy Knoll Fabrics	Holmesville	OH
Yoder Solar	Middlefield	OH
Yoker Valley Variety	Quaker City	OH

PENNSYLVANIA		
A & L Books	Gordonville	PA
Bartville Fabrics	Christiana	PA
Beliers Country Corner	Leola	PA
Belmont Fabrics	Paradise	PA
Blooming Gifts & Beyond	Oxford	PA
Chestnut Level Fabrics	Quarryville	PA
Compass Fabric & Gift	Gap	PA
Country Housewares	Leola	PA
Country Road Varieties	Venango	PA
Country View Dry Goods	Belleville	PA
D & K Frames	Christiana	PA
Daniel's Depot LLC	North Cambria	PA
Elmsport Supply	Allenwood	PA
Elk Creek Dry Goods	Rebersburg	PA
Farm & Home Supply	Shinglehouse	PA
Fishers Country Store	Myerstown	PA
Fishers Housewares	Bart	PA
Green Tree Hardware	Quarryville	PA
Hinkleton Sewing LLC	Ephrata	PA
JR Retail	Howard	PA
Kauffmans Store	Loganton	PA
Mountain View Reuzit	Elizabethville	PA
Salem Road Hardware	Milroy	PA
Shelters Supplies	Greenille	PA
Slate Road Supplies	Ephrata	PA
Smuckers Dry Goods	Leola	PA
White Horse Dry Goods	Gap	PA
Willow Valley Hardware	New Holland	PA
TENNESSEE		
Sunrise Farms	Pleasantville	TN
VIRGINIA		
John Peters Farm Store	Rocky Mount	VA
WISCONSIN		
C & S Small Engine	Cashton	WI
Hene Supply	Withee	WI
SHIPPING ONLY		
Valtea Variety	330.331.2035	
\$59.95 + \$10.00 shipping per order		



The Weather Station Journey

In August 2025, we launched the Weather Forecast Stations, ordering 2,000 units, expecting those to last through Christmas. By November, those were fully reserved, but we didn't have them yet! We finally sent out all the pre-ordered units, first of December. In October, we ordered another 2,000, starting to accept orders for them in January. This new shipment arrived in early February, but given the rapid sales, we might run out before our next shipment, which we ordered in January. Thank you for your patience and continued support. We greatly appreciate it.

Retailers: contact MayKo to order for your store.

Phone: 866.432.2385 | Fax: 330.556.4542 | sales@maykoproducts.com

These are available from Valtea Variety by calling 330.331.2035.

Valtea charges \$10.00 flat rate shipping fee per order.

Request your free wholesale or mail order catalog.

MayKo is wholesale only, Valtea is mail order only.



MAYKO PRODUCTS LLC
WHOLESALE DISTRIBUTION | CUSTOM IMPORTING

HEALTH/HOME

My Best Mornings Start With

Moringa Hot Chocolate – An Easy Way to Get A Lot Of Nutrition!



17 TIMES
the Calcium
of Milk

15 TIMES
the Potassium
of Bananas

10 TIMES
the Vitamin A
of Carrots

9 TIMES
the Protein
of Yogurt

4 TIMES
the Chlorophyll
of Wheatgrass

25 TIMES
the Iron
of Spinach

92 NUTRIENTS
46 Antioxidants,
Omega 3, 6, 9
Zeaxin, Vitamin A-Z

**MORINGA
OLEIFERA**
Malunggay

- Helps in maintaining healthy circulatory system
- Aids in improving elasticity of blood vessels
- Helps reduce high-fat diet-induced obesity
- Gives relief from bronchial asthma
- Beneficial for maintaining healthy brain
- Helps to lower LDL cholesterol and glucose levels
- Improves insulin resistance and glucose metabolism



Start your family off right with a cup of the **MOST NUTRIENT** filled hot chocolate on the market, **CocoRinga**. Children adore it. Adults crave it, and Science approves it! This incredibly tasty and delicious Super Food Hot Cocoa is packed with immune boosting, anti-inflammatory and antioxidant ingredients. A unique blend of Miracle Food Moringa, high fiber plant creamer, and rich dark cocoa. **CocoRinga** helps with regularity, digestion, memory, mood, cravings and a host of other health issues. Drink at least 1 cup a day for 14 days in a row and see the difference **CocoRinga** makes for you.

TAKE THE 12 DAY CHALLENGE

100% ORGANIC | **BioCoffee** | 100% ORGANIC

BioCoffee is 100% organic. A specially formulated blend of Colombian coffee and Wheatgrass. BioCoffee is the only talkable coffee on the market. An instant drink. Just add water. 100% naturally and totally great!

Wheatgrass is one of nature's super foods. It's equivalent to having 35 servings of green vegetables in one cup. BioCoffee is an excellent source of fiber, a great antioxidant and protein, providing chlorophyll, amino acids, vitamins, minerals and enzymes. Helps blood flow, digestion and general detoxification of the body. Wheatgrass is named the King of Alkaline Foods which helps the body from becoming acidic. 30



P.O. Box 289
4860 E Main St,
Berlin, OH 44610

**Place Your
Order Today!**
330-403-3277



**Drink
Alkalizing
Bio-Coffee!**

HEALTH/HOME

PAY BY CHECK

Mail-In Orders Get
FREE SHIPPING!
No need to call us!

Mail order & payment to:
Bushman Music Works
PO Box 172
Marcellus, MI 49067
Do not add anything
for shipping or tax!

BUSHMAN

HARMONICAS

PAY BY CARD

The Fastest, Easiest Way!
To Order by Phone Call us at:
269-858-8773
Mon - Fri 8am - 6pm ET

**Higher quality harmonicas
for lower prices!**

269-858-8773

Mon - Fri 8am - 6pm ET

**Bushman harmonicas
have the best warranty
in the business!**



ROUNDHOUSE

Bushman's most comfortable harmonica. An unbeatable price/quality combination. Great for beginners due to comfort, great for pros due to price, durability, and responsiveness! The Roundhouse whips harmonicas from other brands that cost more than twice as much!!! Comes packed in a black, padded, leather-like, zipper case.

Keys: Low F, G, A, Bb, C, D, and E*

\$29.99



KNITTLINGER

Accordion-like sound of the old Auto Valve only better feeling and much easier to play. Loud and lively, quick and nimble! Features a slick, go-fast mouthpiece. Good players were able to play faster than all previous double reed harmonicas could respond, but you can't outpace a Knittlinger - it goes as fast as any player can play it!

Keys: Low A, Low Bb, Low C, and Low D*

\$99.95



BLUES SHIFTER

This is a diatonic harmonica - not a chromatic - that can play the missing note on Blow 3. Try playing "Amazing Grace" or "What a Friend We Have in Jesus" on a regular harmonica in the lower register - you can't, because there's a missing note on Blow 3. Many songs require that missing note, so they can't be played on a normal harmonica. With the Blues Shifter, when you need that note, just push in the slide button and you have it!

Keys: Low F, G, A, Bb, C, and D*

\$89.99



THE DELTA FROST COLLECTION

- The workhorses of the Bushman brand The Delta Frost comes in 3 different comb choices - Original (plastic), or you can get the Steeie (aluminum), or the Woody (wood). Delta Frosts are the preferred gig harmonica for many professional musicians. Traditional, old school design.

Original Keys:
Low D, Low E,
Low F, G, A, Bb,
C, D, and E*

Steeie and
Woody Keys:
Low F, G, A, Bb,
C, D, and E*

\$29.99

\$44.99



Quickly learn to play popular songs even if you don't know how to read music! This popular harmonica instruction book teaches the basics like how to hold the harmonica, and

how to play single notes, and then it teaches more advanced skills like how to tongue block in order to Double Two Rattle, how to bend notes, and how to harmonize with others! It ends with the very important, rarely known topic, Harmonica Care & Maintenance Guide. That one section will save you many times the cost of the book!

\$9.95



DINKY

Our all new Bushman Dinky has a greater note range and ability to play more songs than any true, 1-1/2" mini harmonica ever made!!! The Dinky plays much better than the typical mini, and it's more comfortable. Here you get all 3 Keys for one low price!
G (Yellow), A (Navy), and C (Black)

3 Pack: **\$14.99**

* All Keys on this page are listed from Lowest to Highest.

COUNTRYSIDE REST

Quaker Church Road • Christiana, PA 17509

Mission Statement:

**“TO HELP WOMEN AND GIRLS
IN NEED OF EMOTIONAL SUPPORT.”**



MISC.

Please complete and include
this form with your gift

Make checks payable to:
Countryside Rest • 215 Forest Hill Rd. • Bird In Hand, PA 17505

Name	
Mailing Address	
Phone	
E-Mail	

Donation Amount:

- \$25
 \$50
 \$100
 \$250
 \$500
 \$1,000
 \$2,500
 Other \$ _____

I want to continue supporting Countryside Rest

- Monthly
 Quarterly
 Annually
 One-Time

I would prefer my funds be used for:

- Building Fund
 Current Needs
 Project Supplies
 Other _____

- Please add me to your mail list.
 Please mail me a receipt.

Without counsel, purposes are disappointed; but in the multitude of counselors, they are established. Proverbs 15:22

BENEFIT RAFFLE for *Sunny Acres School*

**Friday
Evening
March
13, 2026**

Benefit for Special Needs Children

MENU

- Cheeseburger
- Chicken Sandwiches
- Italian Sausages
- Fries
- Salad
- Ho Ho Cake
- Ice Cream
- Pie
- Soft Pretzel
- Iced Coffee

Auction & Drawings

The Heritage Marketplace

**15920 Nauvoo Rd.
Middlefield, OH 44062**



Single Buggy
With disk brakes,
fiber glass wheels
& torsion axels



**Rugger 350 Legend
w/Scope**



**16 ft Mirrocraft Outfitter 160
or \$10,000 Cash Option**

Aluminum Boat
Live Well, Pedestal Seats

Tohatsu 20 hp Motor w/Karavan Trailer
Please check box for either boat or cash option

**Donations, Pickups
or Questions**

Lester Byler 440-636-3562
Marvin Miller 440-313-4784



**\$8,000 Gift Certificate
for bedroom set or
anything equal value
from Cherry Valley Furniture**



**\$2,000
Shopping Spree**
(Winner Receives Cash)



**Extra Large
Green Egg Grill
& Cabinet**



**435 Bernina
Sewing Machine**
With choice of cabinet

Winners are responsible
for all shipping and
transporting of prizes.

Fill out and mail with payment, name, address & phone number to:
Harry/Ida Weaver, 5805 Miller Rd, Rome, Ohio 44085
Tickets: \$20 ea, 6/\$100, 15/\$200, 40/\$500 - Mix or match

For Raffle Questions Call
440-294-2222
DRAWING WILL BE HELD
Friday Evening
March 13, 2026
Winner need not be present to win

Boat-Qty _____ \$10,000 Cash option _____
Buggy-Qty _____ Green Egg-Qty _____ Gun-Qty _____
\$8,000 Gift Certificate for Cherry Valley-Qty _____
Shopping Spree-Qty _____ Sewing Machine-Qty _____

MISC.

Benefit Fish Fry - Auction - Raffle

Late, Samuel Schwartz, Sr. - Medical Expenses

March 13, 2026

Oak Grove Auction Event Center - 5320 U.S. Rt. 322, Shippenville, PA 16254

Doors Open at 3 PM — Raffle / Auction 5 PM



Prize #1: 12Pt premium deerstand
\$4,000 value / \$2,200 cash



Prize #2: XI Big Green Egg bundle
\$3,000 value / \$1,800 cash



Prize #3: Liberty Safe and 2 long guns
\$2,800 value / \$1,200 cash



Prize #4: Sewing Machine
\$2,000 value / \$1,100 cash



Prize #5: Remington 700 bdl., 270
with scope and sling
\$2,000 value / \$1,100 cash



Prize #6: Cash Prize . . \$2,500

For tickets, mail request and check to:

Reuben Schwartz
2231 Knight Town Road
Shippenville, PA 16254

Schwartz Benefit

Name _____

Address _____

Phone _____

If cash is chosen, prize will be sold at auction.

Must check prize or cash.

Prize #	1	2	3	4	5	6
Prize	<input type="checkbox"/>	<input type="checkbox"/>	<input type="checkbox"/>	<input type="checkbox"/>	<input type="checkbox"/>	<input type="checkbox"/>
or						
Cash	<input type="checkbox"/>	<input type="checkbox"/>	<input type="checkbox"/>	<input type="checkbox"/>	<input type="checkbox"/>	<input type="checkbox"/>

Late, Samuel Schwartz, Sr. - Medical Expenses

— Benefit Fish Fry - Auction - Raffle —

Please help with hospital expenses.

Event Date: March 13, 2026

Oak Grove Auction Event Center

5320 U.S. Rt. 322, Shippenville, PA 16254

Doors Open at 3 PM — Raffle / Auction 5 PM

For Info. L.M.: Eli 570-439-8082; Reuben 814-549-0574; or Samuel 814-827-6936

Prizes Valued at \$14,800 - Listed on back of ticket

\$20 per ticket — 6 for \$100

If winners choose cash, the prize will be auctioned following the drawing.

Need not be present to win. Winner is responsible for shipping.

Note: Automatic cash prize if box on stub is not checked.

Please make checks payable to: Samuel Schwartz, Sr., Medical Fund

Plain Protect Voice Connections

Sponsored by

Plain Protect



Kyocera



Basic phone plan options starting @ \$23.00 per month

Atel



Sonim



Lockdown phone plan options starting @ \$25.00 per month

Kosher



Moxee



.....and more.

Ask us about our internet free plans

Looking for something not listed, call us, let's discuss.

Plan questions or pricing please contact

(574) 501-4815

MISC.

Char GOLD

PREMIUM Hardwood Lump Charcoal

**WHEN ONLY THE
BEST WILL DO!**



- Bigger chunks that last longer
- Easy to light
- Gets hot quicker
- Stays hot longer
- Superior product
- Made out of recycled wood

\$26.95

Green Matters

Distributed by:



717-715-3498
332 Hollow Road
Quarryville, PA 17566

Dealer inquiries welcome.
Call for wholesale pricing.



Borkholder

VINYL & CONSTRUCTION

62706 Nottawa Rd.
Sturgis, MI 49091
PH. (269) 659-8588
FAX. (269) 651-2012

Black and Dark
Gray Privacy
Fence!
Available Now!

Are you wanting to make a statement with your deck?

We can help you with:

- Vinyl Railing (cut to custom length)
- Aluminum Railing
- Clubhouse Decking
- Structural Columns
- Millboard Decking
- All Kinds of Colors & Styles
- Low Voltage & Solar Lighting

Transform Your Space — Call Today For A Free Estimate!



MISC.

Draw a line to match the parents to their babies.



YOUR GROUPS. UNITED.



FEATURES:

- Can be done from any phone
- Add your own contacts
- Easy to use on any device
- Create your own groups
- Record your own messages
- **Great for family, church, and business**
- Select groups to send a message to
- RingTele service is not needed (RingTele phone service subscribers receive a \$10 monthly discount)



Phone: (223) 221-7979 Email: sales@ringtele.net
 (877) 828-8353 Fax: (223) 221-7989

MISC.

TROYER MACHINE LLC

CUSTOM DUST SYSTEMS
 DESIGNED - ENGINEERED - INSTALLED

- BLOWERS
- CYCLONES
- BINS
- AIRLOCKS
- WELDED PIPE
- ELBOWS
- FITTINGS



NEW & USED SYSTEMS AVAILABLE

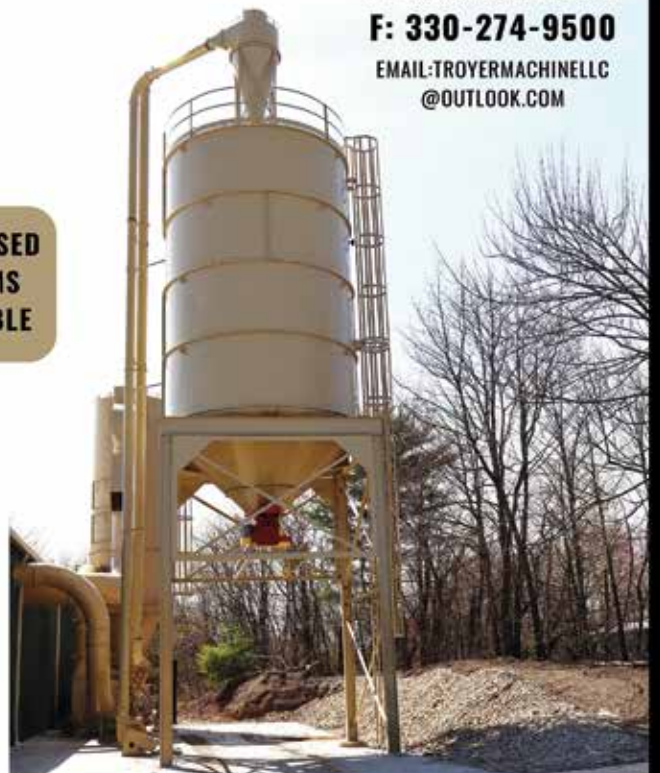

P: 330-674-1592
F: 330-274-9500
 EMAIL: TROYERMACHINE LLC @OUTLOOK.COM

7980 TOWNSHIP ROAD 604 MILLERSBURG OH 44654

SHIPPING AVAILABLE

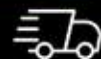

Color Options



LCM 204-Royal Blue



LCM 205-Pink



LCM 206-Teal



LCM 207-Light Blue



LCM 208-Light Purple



LCM 209-Purple



LCM 210-Dark Gray



LCM 212-Orange



LCM 213-Maroon



LCM 215-Green



LCM 216-Yellow



LCM 217-Coral



LCM 218-Olive Green



LCM 202-Black



LCM 203-Red



LASER
DESIGN | PRINT | ENGRAVE | PROMOTIONAL
PAGEONEGROUP.NET



LCM 211-Navy Blue



LCM 214-White

MISC.

Great for gifts and advertising!

20 oz Engraved Stainless Steel Travel Mugs



Personalized with names, logos, and designs!

Image Area: 2.375" w x 2" h

\$43.99 ea. Plus shipping. Volume discounts available.

Includes 15 minutes design time. All prices subject to change.



740-397-0262
 19270 Scott Rd Mt Vernon, OH 43050

MISC.

EXTREME Classifieds



Place a classified ad in **Busy Beaver Extreme** to **Float** to **85,000** homes
\$75 for the first 12 words, **\$3** per word

Call in your classified.....**800-355-2192**
 (Mon - Fri 8-5 EST)

You may also fax **1-800-574-4204** or email **classifieds@busybeaverpublicationsllc.com**

Ads must be paid with credit/debit card (call us w/ info).
 A \$3.00 convenience fee will be applied. All ads must be pre-paid to run.

SUBMIT A CLASSIFIED AD Place one word only in each box below.

\$75.00 for first 12 words			
78.00	81.00	84.00	87.00
90.00	93.00	96.00	99.00
102.00	105.00	108.00	111.00
114.00	117.00	120.00	123.00
126.00	129.00	132.00	135.00
138.00	141.00	144.00	147.00
150.00	153.00	156.00	159.00

SECTION: Horses Dog related Health/Naturals Farm/Garden
 Household Shop/Tools Hunting/Sport/Travel

\$75.00 first 12 words
 \$3 each additional word
 per each Ad Category
 Cost for ONE TIME

1

TOTAL Number of
 issues

2

TOTAL COST
 (Multiply box 1 x
 box 2)

3

EXTREME CLASSIFIED MAIL ORDER FORM

MAIL TO: Extreme Classifieds

7828 Township Rd. 568 | Fredericksburg, OH 44627

Mail-in classified questions....800-218-3405

NO DISCOUNTS ON CLASSIFIEDS

Choosing more than 1 category?
 Remember, you must pay the full ad price for EACH category you check.

Example: \$75.00 ad x 2 categories x 2 times = \$300.00

Name: _____

Address: _____

City: _____ State: _____ Zip: _____

Phone: _____

For FREE, include my: name address phone #

must choose at least one

NEW! 4X EXTREME

Place your ad today to reach **85,000** homes **EVERY 14 DAYS!**

UPCOMING DEADLINES:
 Feb. 3, Feb. 17
 March 3, March 17

SCHROCK OVERHEAD DOOR LLC

574-825-4325

lavon@schrockdoors.com

**AUTHORIZED DEALER OF:
MARDOOR SCREENS**

FEATURES & BENEFITS:

- Garage Door Screen
- Patio Screen/ Wind and Sun Block.
- Don't have to find storage place for it.
- Retracts in minutes!

**NEW!! ROLL-UP
SCREEN DOOR**



MISC.

CUSTOMIZABLE | HIGH QUALITY | VALUED RELATIONSHIP | EXCEPTIONAL SERVICE

NO FRILLS BUILT TOUGH



FEATURES:

- SOAP INJECTOR
- EASY PUSH HANDLE DESIGN
- POWDER COATED CART
- AIR PUMPS

COMMERCIAL MODELS:

- STAINLESS STEEL QUICK COUPLERS
- NON-MARRING 50' HOSE



YOUR LOCAL DEALERS:

OHIO

- Charm Engine**
Millersburg OH 330-893-3033
- Esto Hardware**
Walhounding OH 440-371-2376
- First Quality Power Place**
Middlefield OH 440-632-5068
- Gingerich Hardware & Supply**
Fredericktown OH 567-231-9526
- Martin's Outdoor Power LLC**
Shiloh OH 419-896-2156
- Marco Supply**
Waterford OH 740-525-0344
- Ray's Repair**
Middlefield OH 440-834-1107

- Sapps Run Engine**
Danville OH 740-485-6258
 - Winesburg Lawn & Garden**
Dundee OH 330-359-0330
 - Yoder's Small Engine**
Baltic OH 330-852-8040
- IOWA**
- Troyer Engine Service**
Bloomfield IA 641-929-3330
- ILLINOIS**
- GDS Enterprises**
Arthur IL 217-543-3681
 - Power Plus Equipment LLC**
Arthur IL 217-543-3113

INDIANA

- Corner Lot Pressure Washers**
Nappanee IN 574-773-2578
- County Line Engine**
Ligonier IN 260-593-2792
- Fry's Repair Shop**
Topeka IN 260-593-3228
- Joe's Engine Shop**
Bremen IN 574-546-4413
- Miller's Small Engine**
Grabill IN 260-385-6595
- Schwartz Small Engine Repair**
Marysville IN 812-289-1330
- Waglers Lawn Equipment**
Washington IN 812-254-2446

MISSOURI

- Fry's Repair**
Jamesport MO 660-684-6779

NEW YORK

- Hershberger Manufacturing & Sales**

- Livonia NY 585-601-5152

PENNSYLVANIA

- Ben's Engine Repair LLC**
Fredonia PA 724-475-1144

- Blue Mountain Small Engine**
Newburg PA 717-423-5358

- Creekside Tractor Repair**
New Wilmington PA 724-301-9640

- Honeybrook Hardware**
Honeybrook PA 610-273-3724

- Powerline Equipment**
Dalmatia PA 570-758-2151

- Reihl Equipment**
Ickesburg PA 717-438-3907

- Sensenig's Repair & Sales**
Ephrata PA 717-354-8122

- SS Small Engine Service**
Bird In Hand PA 717-656-0824

- Steveco Power**
Gordonville PA 717-768-7669

- WISCONSIN**
Wayside Small Engines LLC
Colby WI 715-223-2981



BUILT TOUGH by people who know what it takes.

833-893-3254



**LET US DESIGN & PRINT
YOUR NEXT PROJECT!**

- brochures • flyers
- greeting cards • magnets
- posters • invoices
- menus • wedding invitations

- envelopes • banners
- promotional items • labels
- folders • yard signs
- gift certificates • notepads

- catalogs • calendars
- booklets • door hangers
- business cards
- postcards • outdoor signs

740-397-0262
19270 SCOTT ROAD
MT. VERNON, OH 43050
pageonegroup.net
orders@pageonegroup.net



FOR RENT

74HP TRACK MACHINE WITH CAB HEAT & AIR



MISC.

\$30 an Hour + Fuel and
Delivery **\$120** a Day
Minimum

DJ Services | 260-293-0635

Located in LaGrange IN

The Busy Beaver Family of Papers



Seven papers with pages and pages of useful advertising delivered to Amish and Mennonite communities all across North America and Canada! WOW!!



Exposure for your products - Like no other...

With your Ad delivered to over 90,000 homes

EVERY 7 DAYS!

Please contact
Sales & Marketing Manager
Steven Troyer
330-204-9199
ads@busybeaveroh.com

The Busy Beaver of PA+
(Also includes MD, DE, VA, NC & WV)
PO Box 7930
Lancaster, PA 17604-7930
717-568-2380
ads@pabusybeaver.com
Delivered to over 24,000 homes EVERY 7 DAYS!

The Busy Beaver of NEW YORK+ and CANADA
(Also includes ME & VT)
Display Ads: 311 Applewood Ln.
Hilton, NY 14468
585-441-0083
ads@busybeaverny.com
Classified Ads: PO Box 8886
Lancaster, PA 17604
Delivered to over 9,000 homes EVERY 7 DAYS!

The Busy Beaver of FLORIDA
P.O. Box 3
Charm, OH 44617
330-204-9199
ads@busybeaverfl.com
seasonal from October - April
Distribution of 6000 papers weekly EVERY 7 DAYS!

The Busy Beaver of OHIO
P.O. Box 3
Charm, OH 44617
330-204-9199
ads@busybeaveroh.com
Delivered to over 23,000 homes EVERY 7 DAYS!

The Busy Beaver of TUCKESSEE and BEYOND
(Also includes IA, IL, MO, MS, WI, AR, TX, OK, KS, MN, CO, MT, ID, NE, SD & WY)
Display Ads: PO Box 3046
Clarksville, TN 37043
800-886-2704
bbtuckessee@gmail.com
Classified Ads: PO Box 3
Charm, OH 44617
Delivered to over 16,000 homes EVERY 7 DAYS!

The Busy Beaver EXTREME
7828 Township Road 568
Fredericksburg, OH 44627
Phone: 800-218-3405
Fax: 330-470-2240
ads@busybeaverextreme.com
Bi-Weekly publication delivered to over 85,000 homes

The Busy Beaver of MICHIANA
61632 CR 43
Goshen, IN 46528
574-501-5105
ads@busybeavermi.com
Delivered to over 17,000 homes EVERY 7 DAYS!

\$50.00 subscription rate applies to out of state (USA residents only). For delivery of The Busy Beaver™, please contact the appropriate publication.

Helping thousands of people to grow their business. Are you ready to grow yours?



MISC.

U.S. paper companies plant significantly more trees than they harvest, contributing to a net increase of 12 million forested acres over the past 20 years.



Paper is both renewable and recyclable, supporting a sustainable cycle.

- 4/4 walnut 90/70 r-o rules 9.50/ft
- 4/4 walnut fab 5.50/ft
- 4/4 s-maple sab sap 3.40/ft
- 4/4 s-maple 1com sap 1.85/ft
- 4/4 s-maple 2com sap .90/ft
- 4/4 r-oak f&btr 2.50/ft
- 4/4 r-oak 1com 1.85/ft
- 4/4 r-oak 2com 1.40/ft
- 4/4 w-oak qtrsawn sab 4.50/ft
- 4/4 w-oak rift&qtr 1com 2.85/ft
- 4/4 w-oak rift&qtr 2com 1.80/ft

All species kiln dried rough
Truckload quantity pricing and delivery available

DRYTEC
HARDWOODS LLC
231-734-2343

drytec@upwardmail.com

MISC.

ATTENTION

Contractors and Do It Yourself Homeowners...
Use Insulating Concrete Forms (ICFs) for your next project.

ICF Kits Include:

- Free Quotes
- ICF blocks
- Door and Window Buck
- Waterproofing
- Form-A-Drain as Footer
- Rebar
- Small Accessories
- Shipping
- Training Available



Why Use ICFs?

- Rated for 150 MPH winds
- Fire Resistant
- Energy Efficient R-40+
- Noticeably More Quiet
- Attach Drywall and Siding directly to ICF
- Not as heavy
- Forms stay on walls
- Reduce Labor
- Easier to work with during winter

**INSULATED CONCRETE
DECKING SYSTEMS
AND UNDER SLAB
INSULATION
AVAILABLE**

PINE VIEW ICF
DISTRIBUTOR AND INSTALLER OF



ESTABLISHED IN 2006

(765)- 874-1019





DRILLS THROUGH CONCRETE

4000LB CAPACITY

CONSTRUCTION AUGER



CUTS THROUGH 7" SAPLINGS

SKID STEER FORKS



BUSH HOG

HEAVY DUTY/HIGH VISIBILITY



POST SETTER



XED
EXTREME DUTY
compact attachments

BUILT TOUGH, SIZED RIGHT

- SALES & FABRICATION
- CUSTOM AUGERS & ATTACHMENTS
- SKID STEER & EXCAVATOR ADAPTERS

Visit our website:
www.ExtremeDutyAttachments.com

GEAR UP NOW!

570.367.1851

- COMPETITIVE PRICING
- EXCELLENT FREIGHT RATES
- NATIONWIDE SHIPPING!



DRILLS THROUGH CONCRETE

AUGER DRIVES

3 YEAR WARRANTY!

FENCE AUGER



TRUSS BOOM

22' TOTAL EXTENSION



SKID STEER BUCKETS

MISC.



Call for a FREE Catalog!

Airflow Ventilation LLC
Specializing in Airflow Exhaust Fans & Registers

440-548-5628 • 440-591-0872
17108 Bundysburg Road, Middlefield, OH 44062



Solar Attic Vents



Range Hoods

- With fan & lights
- Run by tool battery or 12V

Bathroom Exhaust Fans

Get Rid of Excess Moisture & Odors!

- Run by tool battery or 12V.

We carry mold disinfectants!

Top Quality Powder Coated Floor Registers - Any Sizes!



God bless our HOME with love, joy & peace.



Whole House Ventilation Also Available



**WE WANT YOU TO HAVE THE
BEST GRILLING EXPERIENCE
WITH TOOLS THAT LAST**

RED HOT BUSINESS EMPLOYEE GIFT DISCOUNTS COMPLETE SETS

- | | | |
|------------|--------------|--------------------|
| 2-10 SETS | 5% DISCOUNT | |
| 11-25 SETS | 10% DISCOUNT | RECEIVE 1 FREE SET |
| 26+ SETS | 15% DISCOUNT | RECEIVE 1 FREE SET |



**EMPLOYEE
CHRISTMAS
OR
WEDDING
GIFTS**



SPATULA



**ASH
TOOL**



**PIGTAIL
FLIPPER**

WE CAN PERSONALIZE

CHOICE 94 LLC

2957 CR 600

MILLERSBURG, OH 44654

330-275-5591

DEALER INQUIRIES WELCOME

MISC.

2026 National Taxi Drivers Directory Featured in the MARCH Busy Beaver!



Get more Mileage
out of your ad!

ADVERTISE!!

Be a part of this
Special Drivers Edition!
574-501-5105

Hurry before time runs out!

Deadlines for each region of the Busy Beaver.

Ohio 2/27/2026

Michiana 2/27/2026

Pennsylvania+ 2/25/2026

Tuckesseee 2/25/2026

New York+ and Canada 2/25/2026

MISC.

Pine Lumber OSB Sinkers Nails

Now Stocking

2x4^s 2x6^s 2x8^s 2x10^s in #1 #2

also cheaper grades and treated
Lumber ⁷/₁₄ ³/₄ OSB by the PC bundle or
truck loads here are some pieces

#1 - 2x4x16..... \$6.40

#1 - 2x6x16..... \$9.95

#2 - 2x4x16..... \$5.95

#3 - 2x10x16..... \$12.00

#4 - 2x4x16..... \$4.60

#2 - 2x8x16..... \$10.75

more size on hand

Eli S. Wagler

7394 Co Rd. 9

Montpelier, OH 43543

MISC.

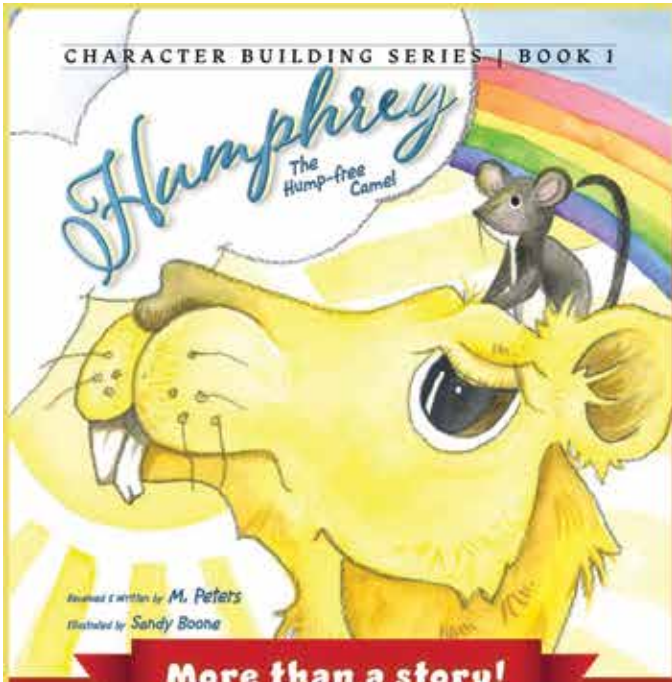

More than a story!

Bible-Based Picture Book

Roll with Humphrey the hump-free camel as he finds the peace that passes understanding and learns contentment. Humphrey is a short, yellow camel with big toes and no hump, unlike the *normal* camels at the zoo.

The first children's book in our character-building series, "Humphrey" is a Bible-based lesson with beautiful illustrations and Scripture memory verses throughout to remind us that God gives us different gifts and He is always listening to our concerns.

Encouragement for all ages.



Out Now!

Book 2 of the Character Building Series

Jonah Elijah

A Tribute to Godly Brethren & Fathers

Walk with Jonah Elijah as he uses his compass and fishhooks to help the villagers he loves. When the stripes of life tempt them to say "I go a fishing," help Jonah Elijah encourage them to cast their net on the right side, dig to find the pearl of great price, check their saltiness, and cover their stripes for true healing.

Encouragement for all ages.

Now Available!

Distributors

Indiana

The Country Barn 574-825-4480

Ohio

93 Stitches 330-260-7313

Page One Group 740-397-4240

A.C. Sales Company 330-695-2344

Paragraphs Bookstore 740-392-9290

Woolson Spice Company 740-392-0936

Miller Footwear and Variety 330-852-0705

Country Furniture and Bookstore 330-893-4455

New York

Hege's Bookstore 717-387-3891



CHARACTER BUILDING SERIES | BOOK 2

Jonah Elijah

A Tribute to Godly Brethren & Fathers:
Encouragement for All.

Revised & Written by M. Peters
Illustrated by Sandy Boone

To learn more and place an order, please contact:

Mrs. John Peters
2625 Fishburn Mountain Road
Rocky Mt., VA 24151
ph: 540.483.3523
cell: 540.352.2793

or see our Distributors to the left.



MISC.



MICHIANA FLIP PHONES

574.326.7331

Internet Free Phones

Give us a call



E4810
DuraXV Extreme



KYOCERA

OpenComm 2
#1 noise cancelling headset



SHOKZ

Flip II X Pro Mini



fig

F1 Pro F1 Horizon



Sunbeam



MISC.

SMART START

BE10500IT
TRI-FUEL Inverter
Generator

NEW LOWER PRICE!
\$3000
INCLUDES GENERATOR
AND 2 WIRE START

- » Runs on three fuel sources (*Natural, propane,* and regular gas)
- » Great solar backup generator and enough power to run a shop
- » Automatic low-oil shutdown for engine safety
- » Copper windings for better efficiency and heat control
- » Weather-protected outlets for reliable power
- » Sound-dampening shell for quieter operation
- » 8500 (gas) 8000 (LP) 6800 (NG) running watts
- » 50 amp output
- » 64 decibels at 25% load



66780 CR 33, GOSHEN, IN 46528

574-642-4353

Is Your Hat Flat?

Large Hat Boxes



Red Oak



The unique beveled design shapes your hat



White Oak

Gray Elm

Hickory

Maple
(Painted & Glazed)

Retail Prices	
Wood Choices	Large Pricing
Red Oak	\$190.00
Hickory	\$210.00
White Oak	\$210.00
Gray Elm	\$225.00
Maple (Painted)	\$335.00

* Wholesale Pricing Available.

† Prices do not include shipping and handling

Call For Wholesale Pricing

Stock Item
Red Oak
OCS & WSC Stain Choices Available

Medium or
Natural Stain



Marty and Laura Miller
8290 ST. RT. 753 S.
Greenfield, OH 45123
V.M.L. (937) 820-1651

Mid Ohio Sliding Door Components

Delrin Wheels with Ball Bearings

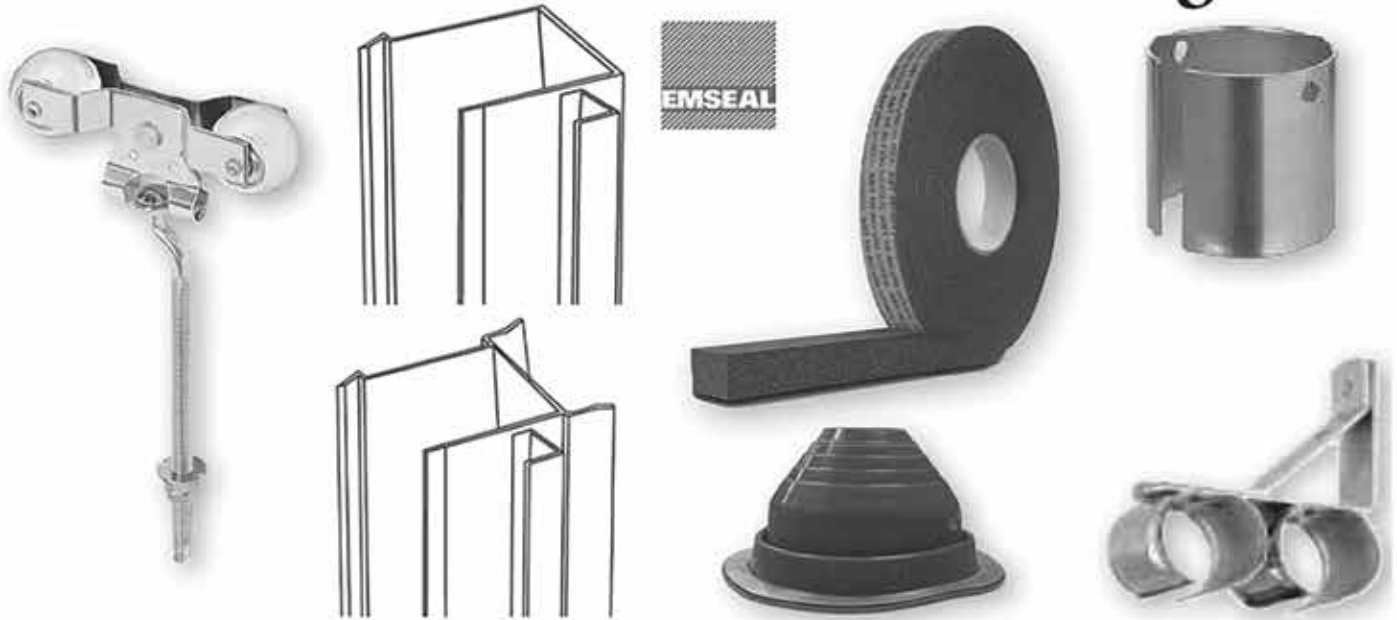

Manufacturing Round Keyhole Track

Palram Duraclad PVC Interlocking Liner Panel



Plyco Insulated Door

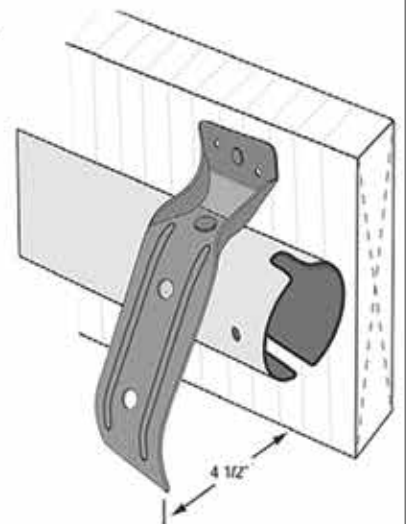

Sunsky 9" Clear



— WHOLESALE ONLY —

FOR PRICING, WRITE TO: 7055 Twp. Rd. 82, Bellville, Ohio 44813

MISC.

No More Wet Shoes and Gloves

IMAGINE!
9 x Quicker
Than Air Drying.



FROM DRIP TO DRY!
PEET dries sopping boots,
soaked shoes, soggy slippers,
and wet gloves with ease.



Glove
Attachment
Included

Item: M97
\$129.99

Original Peet Shoe and Glove Dryer
Power Source 110V Electric
Energy Efficient: Uses Less Energy Than
A Low Wattage Light Bulb
25 year warranty. Made in USA.



Glove
Attachment
Included

Item: P2000
\$179.99

Propane Peet Shoe and Glove Dryer
Power Source: Propane
(propane tank not included) Silently dries
footwear within a couple hours. One 16 oz
propane bottle allows for about 60 hours of
drying time. 1 year warranty. Made in USA.

PEET Dryers
work silently,
you won't hear
any air blowing
or fan noise.
Drys 9 x faster
than air drying.
Simply turn it on
and leave it!
Enjoy!



Item: M06-GDP
\$164.99

Multi Peet Shoe & Glove Dryer
Power Source 110V Electric.
Energy Efficient: Uses Less Energy
Than A Low Wattage Light Bulb
25 year warranty. Made in USA.



Item: M04P-06
\$119.99

Portable GO PEET Shoe & Glove Dryer
Power Source: 12V Battery or 110V Electric.
12 Volt Clips Included. Be Creative and wire your
own Buggy Buddy to convert to Dewalt,
Milwaukee, or Makita. (not included)
Energy Efficient: Uses Less Energy Than A Low
Wattage Light Bulb. 5 year warranty.

David & Anita Yoder, 1550 CR 160, Dundee OH 44624

To Order Call 330-600-8529 or Mail This Form

Name _____
Address _____
City St, Zip _____
Phone _____

Item number _____ Qty _____ Price _____
Shipping for 1 Dryer...(USA order).....\$17.00
OH residents add 7% sales tax.....
Total.....

MISC.



UNLEASH THE BULL

TORO.
Count on it.

\$500 OFF!
Ends Feb. 28

Maximize your efficiency with easy-to-learn controls, top-line reliability, and professional cutting.

Toro's walk-behind mowers are easier than ever to drive, work even better in pastures, and host many new attachments, such as snow plows, dump beds, light kits, spreaders, and sprayers. Available in 36", 48", 54", and 60" decks.

HONDA



The best time to own a Honda generator is before you need one.

Always read owner's manual before operating Honda Power Equipment.















7700 State Route 241,
Millersburg, OH 44654
330-674-4329
Mon-Fri: 7-5 • Sat: 7-11

Giveaways with a Greater Purpose.



What if your company giveaways benefited individuals at a plain communities workshop?



Heartland

W H O L E S A L E LLC

62788 CR 37 Goshen, IN 46528

574-642-4360 x2 | sales@heartlandwholesale.us

Call to see how we can work together to make a difference!

Article space donated to CAM

A channel enabling the church to minister to physical and spiritual needs around the world



Civil war has left many Yemeni families struggling to survive. With tears, one recipient shared, "I thank [CAM contacts] for helping people in need like us."



FOOD FOR WAR-TORN YEMEN

Parcels of love

In our country where war is a distant thought, it is difficult to imagine the suffering of people in Yemen or other countries where the horror of war is reality, pain is felt, poverty abounds, and hunger claims lives.

Kamal* is a Yemeni father who had to leave his home and job because of heavy shelling.

Huda is a mother of five whose husband died, leaving her with the full responsibility of raising her children alone.

Rania and her family of seven live in a house with a collapsing roof, allowing water to pour in every time it rains.

Your kindness enables CAM to show Jesus' love and care through the gift of food parcels to suffering people in Yemen. Thank you!

*Names have been changed to protect identities.

Response Coupon

FOOD FOR WAR-TORN YEMEN (YFP): \$100 provides suffering Yemenis with a 170-pound parcel of food and some cooking gas

- \$50 \$100 \$250 \$500
- \$1,000 \$2,500 \$5,000 \$10,000
- \$15,000 \$25,000 \$ _____ any amount

Make checks payable to **Christian Aid Ministries**
 P.O. Box 360 | Berlin, OH 44610
 To make a donation by debit/credit card, please call us at **330.893.2428**.
A receipt will be sent unless otherwise noted.

- Check here if you DO NOT wish to have a receipt.
- Check here if you wish to have only a year-end statement.

Name _____

Address _____

City _____ State _____ Zip _____

Phone _____

MISC.

MAXIMIZE YOUR SPACE

With Our Pallet Racking, Cantilever, & Shelving Solutions

Pallet Racking

Cantilever

Shelving

From metal materials and lumber to pallets, boxes and retail products, we have the racking solutions you need. Call today for a free quote.

Call Or Stop By Today For A Complete List Of Products



2016 Clark C800 Diesel, 16,000 lb cap, 2 stage, fork positioning, 3,714 hrs \$24,100



2021 Toyota 8FGCU25 LP, 5000 lb cap, 3 stage, sideshift, fork positioning, 7,904 hrs \$11,900



2019 Aisle Master 44SG LP, 4,400 lb cap, 3 stage, sideshift, fork positioning, 15,851 hrs \$7,200



2019 Crown RR5725-35 EL, 36V, 3,500 lb cap, 3 stage, sideshift, 9,783 hrs \$5,700



2015 Moffett M55.4 Diesel, 5,500 lb cap, 2 stage, sideshift \$22,100



Komatsu EL, 24v 4,000 lb cap, 3 stage, sideshift, 6,452 hrs \$2,900



2019 Skyjack SJIII3219 EL, 290 hrs \$3,100



2018 JLG 10MSP EL, 120" platform height 290 hrs \$2,500

Financing • Rentals • Delivery • 30 Day Warranty
Call Today For More Info

Industrial Systems Group is a division of Yoder Produce inc.
 9599 S. Apple Creek Road Fredericksburg, OH 44627
 Phone: 330.695.5900 Email: sales@yodersproduce.com



Superior Products For Food Storage, Baking, & More!

QP
QUALITY PLASTICS, LLC
Plastic Injection Molding



Helping You Develop An Alternate Solution

From practical features to advanced material options, let us help guide you from design to finished product on the market. Call or stop by our location to discuss your ideas.

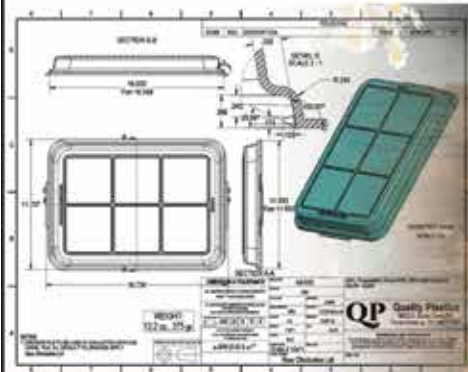

Find QP Products at your local store
Or online at: store.qualityplasticsllc.com

330.695.5920

9602 S. Apple Creek Road Fredericksburg, OH 44627
www.qualityplasticsllc.com

MISC.

2026 DEADLINES: February 3 • February 17 • March 3 • March 17

THE BUSY BEAVER EXTREME™ 2026

The Busy Beaver **EXTREME** is now mailed **EVERY 14 DAYS!**
 4 X more options to grow your business with covers, display ads, classified ads and inserts.

ADVERTISE MORE, SAVE MORE WITH OUR MULTI-RUN DISCOUNTS!

RUN 2 TIMES: 10% DISCOUNT • RUN 3-4 TIMES: 15% DISCOUNT • RUN 5 OR MORE TIMES: 20% DISCOUNT

AD SIZE	REG PRICE	10% OFF (2 TIMES)*	15% OFF (3-4 TIMES)*	20% OFF (5+ TIMES)*
Extreme Classified	\$75 <small>For first 12 words</small>	Refer to the Extreme Classified Ad Form for pricing		
1/4 PAGE (3.5"w x 4.75"h)	\$655	\$589.50	\$556.75 PER TIME	\$524 PER TIME
1/2 PAGE HORIZONTAL (7.25"w x 4.75"h)	\$895	\$805.50	\$760.75 PER TIME	\$716 PER TIME
1/2 PAGE VERTICAL (3.5"w x 9.75"h)	\$895	\$805.50	\$760.75 PER TIME	\$716 PER TIME
FULL PAGE (7.25"w x 9.75"h)	\$1485	\$1336.50	\$1262.25 PER TIME	\$1188 PER TIME
FRONT COVER (8.125"w x 10.75"h) <small>+ .125 bleed @ .25 safety</small>	Call for availability and pricing			
BACK COVER, INSIDE FRONT COVER (7.25"w x 9.75"h)	Call for availability and pricing			

***TO RECEIVE THE 10%, 15% OR 20% DISCOUNTS, ALL ADS MUST BE PAID IN FULL AT TIME OF ORDER. NO OTHER DISCOUNTS CAN BE APPLIED. CALL FOR MORE INFO.**

Need catalogs and flyers sent as onserts with the Extreme? Call for pricing.

Busy Beaver Extreme • 7828 Township Road 568 • Fredericksburg, Ohio 44627
 email: ads@busybeaverextreme.com • Phone: 800-218-3405 • FAX: 330-470-2240

BUSY BEAVER EXTREME AD ORDER FORM | 2026

Horse name or item you're advertising: _____ Designer: _____

Business Name: _____ Contact: _____

Address: _____ City: _____ St: _____ Zip: _____

Phone: _____ Fax: _____

Email: _____

• AD SIZE: 1/4 1/2 Horizontal 1/2 Vertical Full Times to run: _____

• SECTION: Horses Dog related Health/Naturals Farm/Garden Household Shop/Tools Hunting/Sport/Travel

• DO WE HAVE YOUR AD ON FILE? No Yes: Date last ran: _____

• IF NOT, HOW WILL YOUR AD BE SENT TO US? Mail Email

PAYMENT INFO: INVOICE# (office use only): _____

Check # _____ Amount \$ _____

Type of card: American Express Visa MasterCard Discover

Credit Card#: _____

Name (as it appears on the card): _____

EXP. DATE: _____ CVC CODE (on back): _____

Phone #: _____
(required for credit card use)

ALL ADS MUST BE PRINT-READY WHEN SUBMITTED.

This special publication will be printed every 14 days in full color and delivered to over **85,000 homes***!

(*NY, ME, MD, DE, VT, VA, NC, WV, PA, OH, MI, IN, KY, TN, IL, WI, MO, IA, MN, AR, TX, OK, KS, CO, MT, ID, NE, WY & Canada)

WE RESERVE THE RIGHT TO REFUSE ANY ADS WE DEEM INAPPROPRIATE. Busy Beaver EXTREME is not responsible for the claims and outcome of products advertised within.



MISC.

Affordable Office Solutions

Declutter your office with our wall hanging file organizers. Keep your job and project files neatly organized

Dealer Inquiries welcome



Standard shelf size is 9" x 11"



All sizes available in Plain Aluminum or Black Powder Coat



Shelves & Panels can be sold separately. Call for pricing.

Can be used to store clipboards!



Also available in single leg options with 9½" shelves



Red arrow pointing to tabs: Tabs allow labels for each shelf.

Call today for pricing and brochure - Multiple options available

Little Mountain WELDING



310 Heck Road, Jersey Shore, PA 17740

570.745.2240

MISC.



I highly recommend you to secure your copy today
 The book is both profound and easy to understand.
 It will instill in you a sense of confidence to achieve
 and be the person you've always aspired to be. For
 some, it may be a first-time experience in their life.

Available on Amazon.

Feel free to share your thoughts on the profound content within the book.

5starsuccesscoaching@gmail.com | Coach.5starsuccesscoaching

Coach 303-408-9118

A-M GUTTER GUARD™
 The Difference is in the DESIGN

EASY TO INSTALL IN NEW OR EXISTING GUTTERS

- Designed specifically for hidden hangers but works with all hangers
- Heavy gauge .018 - 100% aluminum will never rust
- Invisible from the ground
- Handles downpours
- Pest and weather (snow/ice) resistant
- Easy to install on new or existing gutters
- Does not make contact with shingles (will not void shingle warranty)
- Eliminates gutter clogging



Installers get .40 a foot off
 with **FREE SHIPPING** if you
 order a skid!

How Do A-M GUTTER GUARDS Work?

Our unique bubbled filtration system allows rainwater to pass through our patent pending design while leaving debris to dry and blow away. Our maintenance-free design not only keeps debris from sticking; it promotes airflow from top and bottom allowing debris to dry and blow away in winds as low as 5 mph.

RATED #1 BY GOOD HOUSEKEEPING!



RAYDEN ENTERPRISES LLC

Home of A-M Gutter Guard | Where Quality Comes First

Ray and Aden Miller | 440-321-5336
 13970 Old State Rd., Middlefield, OH 44062

MISC.

NOW OFFERING DISCOUNTED BUILDING PACKAGES!

NO job to small, NO job to big!

Please call us with any questions!

937-446-0298



9890 Baker Hanselman Rd
 Georgetown, Ohio 45121

The Original WATER REVITALIZER



Home, Farm, Business, Garden

Additional units can be installed where needed for even greater results.



Additional plumbing not included

Stray Voltage/ Static Unit (2 pieces) **\$1527.00**

STAINLESS STEEL



Stainless Steel Garden Hose Unit (includes fittings) **\$598.00**



Stainless Steel Whole House Unit Unit is attached to the incoming water supply. **\$1098.00**

Soften your water Natures Way!

Distributed by:



717-715-3498
332 Hollow Road
Quarryville, PA 17566

Dealer inquiries welcome. Call for wholesale pricing.

EXPANDABLE SYSTEM, USES NO ELECTRICITY, 120 DAY MONEY BACK GUARANTEE

Physically, as water passes over, around and through the helix formations inside the NU-FORCE Water Revitalizer, the actions churn the water similar to the action of water rolling and tumbling over rocks and crevices down a mountain stream. Enjoy all the benefits of revitalized water for cooking, drinking, showers or baths, laundry, gardening, pets and so much more.

MISC.

Are you ready for spring?

ALL PURPOSE CLEANER

Heavy duty soap cleans RVs, boats, awnings, tractors, lawn mowers, vinyl siding, vehicle interiors, fabrics, carpets, and clothing.

- 1 Gallon Jug.....**\$ 35.00**
- 5 Gallon Bucket**\$152.00**

ONE PUNCH CLEANER

An ecofriendly, biodegradable, aggressive vehicle cleaner. Excellent for heavy equipment, farm equipment and shop floors. *Do not use on anodized or mirror polished surfaces.*

- 1 Gallon Jug.....**\$ 35.00**
- 5 Gallon Bucket**\$152.00**

DEGREASER CLEANER

Our Degreaser is formulated to cut through oil without using harsh chemicals. Remove oils and heavily soiled grime from engines, concrete garage and shop floors, commercial kitchens, and areas around your house.

- 1 Gallon Jug.....**\$ 35.00**
- 5 Gallon Bucket**\$152.00**

BUGGY WASH & HARNESS CLEANER

Our foaming soap solution will eliminate dust and dirt from your buggy and equine equipment.

- 1 Gallon Jug.....**\$ 35.00**
- 5 Gallon Bucket**\$152.00**

Cleaners that work on everything including: Buggies, Laundry, Kennels, Equipment, and so much more!

KENNEL CLEANER

Highly effective cleaning product for dog kennels. Contains essential oils, which will eliminate odors and leave your kennel with a clean scent. *Not for direct use on animals.*

- 1 Gallon Jug.....**\$57.00**
- 5 Gallon Bucket.....**\$262.50**

BEARCAT TRUCK CLEANER

Our heavy duty alkaline soap attacks road film, bug residue, soot, oils and grease. Our product is polish safe and doesn't etch aluminum, so your truck will have that long-lasting shine!

- 1 Gallon Jug.....**\$ 35.00**
- 5 Gallon Bucket**\$152.00**



Make It Shine....
The Easy Way!



Farm Moving Sale March 2nd to 7th

Farm Equipment • Parts • Clocks • Misc

New Miller's repair wagon gear \$2100. • 2 Used wagon gears \$450. and \$500. • 1 Ton wagon with box \$1000.
 NI 3 bar rake \$400. • NI 5 bar rake \$500. • Forecart \$600. • Back Blade \$550. • Gravity wagon D.A. gear \$500.
 Rosental 40 husker shredder \$500. • McCormick 9 bar hay loader \$1100. • NI hay loader for parts \$100.00
 Grain Binder w/parts \$85. • NI No17 rebuilt spreader \$3500. • IVA 2 row cultivator \$750.
Pequea tedder air or steel \$1200. • D.A. left plow \$450. • Brillion 12ft. packer \$800.
 D.A. 8ft. cultmulcher w/tongue truck \$2750. w/rear wheels \$3000. • McCormick low tie corn binder Mint \$1500.
 JD No 3 Hay mower \$3000. • NI No10 hay mower \$600. • McCormick big 6 mower \$800.
 Oliver hay mower needs pitman shaft \$500. • 5-old open gear hay mowers -Ideal reaper \$300.
New Ideal grain binder \$600. • 3 sets of scaffold \$150. • Fuel Tank \$35. • 2-10ft calf feeders \$200 ea.
 6 calf tie hutches buckets and holders \$175. ea. • 2 sets 8-bolt spreader wheels \$100. to \$200 a set
 Lots of other wheels, • 2 walking plows painted \$200. to \$250. • New white skylight \$3.00 a foot
 2-12x20 ft. plastic culverts \$50. ea • 100 Cement blocks \$.50 each • 1ton jib crane Post is 13 ft. swings 360° \$750.
 Dual chain hoist \$150. • Pony size fore cart shafts \$75.00 • 2 pony size steel tongues -w- eveners \$50. ea.
 3 JD Model E-11/2 hit-n-miss 1 McCormick model M 1 1/2 hp. \$750. • 2 hp. - 3hp. Cushman Cub \$400. ea.
 Single and double eye. maytags • shelf clock \$40. • Howard Miller chime clock \$125. • Wall clock \$75.
 Fresh Ground spelts \$.50 a pound

Melvin Weaver
5484 Tamarack Rd.
Ossco, MI 49266

You're busy out here . . .



Let us help you advertise in here.

Call your Area Marketing Representatives, Faron and Jon, at 574-501-5105 and reach thousands of potential customers.



KEA CABINET SOLUTIONS

Save up to 75% compared to Custom Cabinets
 773-346-2190

M&L
Appliance

13534 Stellhorn Rd | New Haven, IN 46774
 PH #: (260) 600-1971 FAX#: (260) 258-5911



REFURBISHED PAINTED TANKS

STAINLESS STEEL FUEL TANKS

DELIVERY OPTIONS AVAILABLE!

No rust is your fuel

- 100 gallon
- 200 gallon
- 300 gallon
- 500 gallon

STAINLESS STEEL STAND

For: Gas, Kerosene & Deisel



SUPERIOR METALWORKS

We also carry Propane Appliances!



Centaur

HTP® FENCING SYSTEMS
 The Horse Friendly Fence®

POLY FENCE POST WOOD FENCE POST
 Drop ship options available on Centaur Fencing

BLACK OR WHITE ELECTRIC OR NOT



FARM

Plant Male Sterile Silage Corn for Grass-fed Dairy or Beef

KF 60S60 from Byron Seeds is a 110-day male sterile silage corn hybrid ideal for farms in niche markets that do not want grain in the diet. This hybrid can produce high-quality silage without grain for grass-fed producers.

- KF 60S60 can be very high in sugar if grain is not formed.
- **Plant it 2 weeks after nearby cornfields to avoid pollen from the neighbor's corn.**
- Isolation from standard corn is important.
- The hybrid features a wide harvest window and a very good disease package.



Photo on left: The closest corn was a quarter mile away.

To order KF 60S60, contact your local Byron Seeds Dealer or call 800-801-3596 for service



Byron Seeds



FARM

Struggling with Parasites?



Virtually all sickness and disease can be traced back to mineral deficiencies or imbalances.



Hy-Brix Free Choice is a natural parasite fighter. In independent studies, it has proven to reduce, and in some cases, eliminate parasites in your flock. A mineral blend of over 72 trace minerals and sea salt to fight parasites and promote overall health.

Contact us to find a dealer near you.

888.803.8811

sales@naturalwayminerals.com

E.H. TRACTOR SHOP LLC

...serving you with all your machine marketing needs

CYLINDER BLOCK MACHINING



- Cylinder Boring
- Cylinder Honing
- Repair Sleeves

Crankshaft Grinding



- Tires & Tracks
- Foam Tires



DYNAMIC

- Cuts up to 2 1/2 in. trees
- 3 Blades
- Wheel kit option
- Dual position hitch option



POWER HARROW



FOR SALE or FOR RENT

- Excellent Weed Control
- Less Compaction

- Excellent Seed Bed
- Multiple Sizes

CYLINDER HEAD MACHINING



- Resurfacing
- Valve Job
- Magnflux
- Coldweld

- Connecting Rods
- Pin Bushing Honing

- Engine Rebuilding
- Complete Overhaul Kits

BRUSH BUSTER

- Heavy Duty
- Cuts Up to 4" Trees
- Dual Position Hitch



- Transmissions
- All Brands Gas & Diesel
- Construction Equipment



Flavor Seal Bale Wrap
Dutch Harvest Net Wrap
Baler Twine



- Skid Loaders -All Brands
- Telehandlers
- Rims -All Sizes

- Engine Overhauling
- Clutches

Jonathan, Elmer & Perry Hochstetler

2100W 350N • Howe, IN 46746

Open Mon-Fri 6a-3p Sat by Appointment



260-463-3314

Financing Available



FARM

It's time to start applying OVB to your fields and gardens.



OVB
OHIO VALLEY BIOCHAR

There is a Better Way



Actual results after 2 applications of BioChar.



Also available in
1.2 cubic foot bag



OVB
OHIO VALLEY BIOCHAR
234-286-0259

If you want better nutrition... you need to start with better soil

Biochar blends available for various farming needs, call for more information.

WHAT IS BIOCHAR?

Our Biochar is steam activated carbon that is beneficial for our soils and animals

- Biochar creates a biology in your soil that saves money on fertilizer inputs.
- Biochar has the unique ability for attracting and holding moisture, nutrients, and agrochemicals, even retaining difficult to hold nutrients like nitrogen and phosphorus. Nitrogen and phosphorus tend to run off regular soils, upsetting the ecosystem balance in streams and water ways.
- Biochar creates better bedding for chicken houses, dairy cows, sheep, and horses.
- Mix it to your feed for better animal health, and a good manure.

WHAT IS THE BENEFIT TO YOU?

- Saves costs over high fertilizer year after year.
- Creates a healthier environment for you and your family.
- No dangerous side effects to humans, animals, or ecosystems.
- Puts more dollars in your pocket.



Distributed by:



Keystone Sales

717-715-3498
332 Hollow Road
Quarryville, PA 17566

Dealer inquiries welcome.
Call for wholesale pricing.

Now carrying the full line of **Blue GOLD** PRODUCTS



QUESTIONS
FOR SEA-90?:
(770) 361-6092

TWO-STEP SOIL HEALTH PROGRAM:

1
Activate native soil biology

- Apply Sea-90 Bio-Wave: 1 Quart / acre
- Powered by proprietary spore-based technology, and mixed with Sea-90 Ocean Minerals, our product stimulates soil bacterial and fungal life in ANY environment

**BIO-WAVE
MAX™**

SPORE-BASED SOIL CONDITIONER

Spore-Based Biostimulant
+ Kelp and Humates

2
Deliver ocean minerals to fuel soil microbiome

- Field Broadcast Sea-90: 100 – 150 lbs / acre
- Feeds the soil matrix – provides a nutrient source for microbial, bacterial, enzyme, and fungi life, supercharging soil health and productivity

Agriculture **SOIL
MINERALIZER**

FOR BROADCAST SPREADING

Original Sea Solids for Soil
Micro-Biome + Humates

AUTHORIZED INDIANA / MICHIGAN DIST.:



**SUNRISE
SEEDS PLUS**

(260) 463-0380

Heritage Nutrition

(989) 386-3664

BELTS! BELTS! BELTS!

- Bale Thrower Belts
- Round Baler Belts
- H&S Hay Merger Belts
- Oxbo Merger Belts
- NH Inverter Belts
- Pre-Punched Pick Up Head Belts
- Grain Elevator Belts
- Grape Harvester Cleated Belts
- Sawmill Related Belts
- Sanding & Moulder Belts
- Endless Transmission Belts
- Sand & Gravel Belts

We build custom conveyor rollers.



Check with us before buying factory direct.
Excellent after market pricing on Merger & Baler belting.

Most belts in stock and ship UPS daily.

Flexco Alligator & Clipper Lacing Distributors

Need a custom belt made? Give us a call.



7724 Banks Road • Gainesville, NY 14066 • 585.567.2358
Hours are 7:00 to 3:30 pm Monday through Friday.

Nelson Yoder • 574-330-9923

12082 CR 46 • Millersburg, IN 46543

The Grazing
FLEDMASTER



HAY FEEDER

Formerly known as DKM Feeders

*The most universal
grazing system available!*

Time To Feed Your Trees!

Right now in the fall is the best time to feed your trees (this is when they pull in nutrition for the winter and spring months)



Tree Secret®

- All non fruit-bearing trees, evergreens and bushes.



Chicken Soup for the Soil®

- All fruit trees, flowering perennials, and flowering bushes.



Before



After

Tree Secret® liquid tree fertilizer (formerly known as Save-A-Tree®) is a biologically correct (non-synthetic) tree fertilizer that has been created specifically for enhanced tree success. Our small-batch, extra-potent blend of readily available nutrients is exactly what your trees, plants, and bushes need to revitalize and look great for years to come. The competition does not come close!

- Nitrogen found in most chemical lawn fertilizer is largely responsible for the unnatural rapid growth that weakens trees by thinning their protective cell walls, opening the door for disease, wind damage and bug infestations.
- Plants and bushes need the same nutrition as slow-growing trees. Give your yard a serving of this ultra-potent undiluted, carbon-based fertilizer and watch in amazement as your trees thrive and your landscape transforms into a lush paradise.
- Excellent results on all trees and bushes, including evergreens!



64oz JUG
\$34.95



APPLICATION INSTRUCTIONS

The amount needed for best results depends on the diameter width of the tree trunk 4' up from the base of the tree.

- Use 1 cup per caliper inch of tree trunk (trunk diameter)
- Mix with water and evenly apply from the base of the tree to the drip line.
- Water into the root zone.

To SAVE a dying or stressed tree, apply in spring and fall.

To MAINTAIN good tree health, use one time per year in spring or fall.



Happy trees have fewer problems. This stuff works!

ORDER TREE SECRET® TODAY!

Free Shipping & Full Money-Back Guarantee

CALL 518-483-4178

Name: _____	Quantity	Description	Unit Price	Total
Address 1: _____				
Address 2: _____				
City: _____ State: _____ Zip: _____				
Email: _____	Mail check or money order to:		Subtotal	
Phone: _____	Ezra Yoder 231 Coveytown Rd Constable, NY 12926		SALES TAX	
	(sales tax applies except AK, DE, MT, NH, OR)		TOTAL	

Best Natural Fertilizer On Earth

“Chicken Soup for the Soil® improves your soil by feeding the microbes and supplying all the nutrients most fertilizers neglect.”

- ✗ Grow higher quality fruits & vegetables with more color, better taste, less bug infestations & disease.
- ✗ Contains all the elements in the periodic table (sea nutrients, amino acids, humic, fulvic, and other herbal extracts).
- ✗ All natural, toxin free, & bioavailable.
- ✗ Non-leaching formula / nutrients accumulate over time.
- ✗ Perfect for gardeners, growers, ranchers and farmers.



64oz Jug
34.95*
+ Free Shipping!!



*Makes up to 128 gallons with 1 tablespoon per gallon. Full Money Back Guarantee!

*Commercial quantities available - Works On Pastures

CALL 518-483-4178



★★★★★ 2285 Reviews



We Sell Bulk To Farmers
518-483-4178

At Dr. JimZ®, our main goal is to help people eat more nutritious food and be more successful in the garden. Our nutrients are designed to stimulate life in the soil and provide a plethora of nutrients at a biological level. **The microbes in the soil must consume the nutrients before they are 100% bioavailable to the plant.** Our products feed the microbes so your plants can then decide what nutrients they need and when they need them ... this will maximize the genetic potential of the plant and result in higher-quality fruits and veggies.

2025 Cost of Bulk Chicken Soup for the Soil®*

*Prices subject to change

- 55-gallon barrel: \$9 per gallon + Shipping
- 270-gallon totes: \$9 per gallon + Shipping
- 5,000-gallon truck loads: \$6 per gal + Ship

Call 518-483-4178 to get quote and place order! Full catalog also available.



**Hay - Pasture - Hemp - Corn - Wheat - Orchards - Grapes
Veggies/Fruits - Feed The Microbes - Soil Health**

Midwest Farm & Pet, LLC

Full Line of Feed, Seed, and Pet Supplies



574-646-2509

535 5B Rd, Bremen, IN 46506



Annual Check-R-Board Days
March 6-7th
 See our ad in the
February 19th People's Exchange

NEW FREE DELIVERY

- Order 10 bags or more of any feed
- Nappanee community (10 mile radius from store)
- Place orders by Tuesday 3:30 pm for Wednesday - Friday delivery
- Must be paid with either cash or check

HORSE		CHICKEN		DOG	
Tribute/Purina/GroStrong		Egg Krumbs 16%	15.99	Tuffys Gold 26/18	32.99
Impact 14:6 pellet	19.99	NonGmo Layer Mash 17%	16.99	Buy 10 get 1 free	29.99
Buy 10 get 1 free	18.17	Kalmbach Layer Pellet 17%	17.99	Supreme Hi Pro 27/10	24.99
Midwest Sweet Feed 12%	14.99	Kalmbach Layer Crumb 16%	16.99	Tuffys 30/20 Puppy 50#	43.99
Impact Pro Perf 14/8	23.99	Chick Starter 22%	17.99	ProPlan 30/20	68.99
Essential K 28%	29.99	Chick Grower 20%	14.99	R.C. Small Starter	85.99
Hershey Performance	20.99	Gamebird Starter 26%	16.99	R.C. Small Puppy	74.99
Yoder Brothers	19.99	Gamebird Grower 22%	14.99	R.C. Small Adult	68.99
Mineral Tubs	Various	Organic Layer Mash	20.99	Eukanuba Small Puppy	78.99
Right Choice Solutions 14	15.99	Sauders 16% Rabbit Pellet	16.99	Eukanuba Small Adult	74.99
3 ton direct - bags	15.00	Duck Grower 14%	13.99	Green Pride 26/18	39.99
DEWORMERS/VACCINES		Tuffys 40# Cat	26.99	Black Pride 24/20	37.99
Ivomec Inj 50 ml Liquid	32.99	O.La.Joes 16% Deer Pellet	18.99	Pride Puppy 30/20	47.99
Zimectrin Tube	8.99	Hi Fat Sheep Tub 200#	120.99	V.P. Black Grain Free 28/20	39.99
Quest Plus Tube	19.99	BEEF/GRAINS		NS Small Puppy 32/21	52.99
EquiJec 6 Vaccine	39.99	Whole Corn 50#	7.99	NS Starter 30/21	47.99
Rhino, Influenza, Tetanus, West Nile		Cracked Corn 50#	8.49	VACCINES/DEWORMERS	
Rust Remover Softner Salt	7.99	Oats 50#	13.99	Nobivac 5Way tray	109.99
Shavings - Clear Bag	5.49	Dairy Beef 38 Concentrate	17.99	K9 Spectra 5Way tray	105.99
SEED/FERTILIZER/SPRAYS		BIRD SEED		Neopar 10ds bottle	37.99
Sunny Mix Grass Seed 50#	129.50	Black Oil Sunflower 50#	24.99	Safeguard 125mL	33.99
Champion Pasture Mix 50#	193.00	Yoder Mix 40#	43.99	Safeguard 1000mL	175.99
Renovator Pasture Mix 50#	139.50	Woodpecker Blend 20#	35.99	Pyrantel 16oz	25.99
Food Plot Seeds	Various	Nyjer Seed 10#	20.99	Pyrantel 32oz	42.99
19-19-19 Fertilizer	24.99	AQUARIUM		Pour On Ivomec 250mL	19.99
4 Step Lawn Fertilizer Program		Amoxicillin 500mg 100ct	49.99	3cc Syringe w/needle 100ct	12.99
Round-Up - 2.5 Gallon	59.99	Penicillin 500mg 100ct	50.99	Elite Products	Various
2,4-D - Gallon	25.99	Doxycycline 100mg 100ct	44.99	Juru Products	Various
Nutrient Plus - 2.5 Gallon	94.99	Metronidazole 500mg 100ct	54.99	Flea Products	Various

PRICES SUBJECT TO CHANGE WITHOUT NOTICE

FARM

**Rotates
355 degrees**



330-275-8602



Indoor/outdoor security camera

- video & audio recording
- completely portable
- system is AC or DC
- wireless connection
no internet needed

WATCH YOUR DOGS/HORSES FROM THE HOUSE!

Canine Quick Tests



- ~ Brucellosis
- ~ Giardia
- ~ Parvo

(\$75 for 10ct box)

Healvet

- Detect Peak Ovulation
- Determine C-sections
- Increase litter size
- All in your own home!

Also have Wondfo tests in stock

Mini Microchip
prices are as follows;

- 1-99 pcs
\$2.00 each
- 100+ pcs
\$1.75 each

Rechargeable Scanners \$60





Proven results under microscope.

A healthy gut is the first step to a successful relationship with your dog!

Joy Gold

Use Joy Gold in your everyday feeding program and eliminate Diarrhea, Giardia and Coccidia

GUT HEALTH:

- Removes toxicity from body
- Helps eliminate loose stool
- Promote better gut health and eliminate unwelcome visitors
- When dog is healthy, increases odds of bigger litters
- It is not about selling a puppy, it is about providing healthy puppies to your client and you will have happy repeat customers!

2 quart Canister\$69.98
3 gallon bucket.....\$227.98

GUT BIOME:

- Without a healthy gut your dog will struggle
- Happy dog - happy owner
- Dogs love Gut Biome, no need for nasty tasting pastes and slurries
- Let's treat the problem/issue instead of the symptoms

Gut Biome 16 oz\$46.98

Distributed by:



717-715-3498
 332 Hollow Road
 Quarryville, PA 17566

Dealer inquiries welcome.
Call for wholesale pricing.



Everything you need

to DIY your kennel, and keep your dogs healthy!

At **GREAT PRICES!**

Call for a Catalog

717.435.8222 ext 102

We Offer Many Types Of Kennel Panels And Fencing



We carry everything you need for grooming!



Many Types of Dog Doors with features to make kennel care better!



We offer many types of dog collars! From heavy duty regular collars, and no bark collars to GPS tracking collars!

Vaccines at Amazing Prices!



WE Offer the full line of ELITE NUTRITION PRODUCTS!



Tried and Proven Kennel Care and Components!



- Kennel Fencing**
- Trusscore Panels & Trim**
- Andis Clippers & Blades**
- Grooming Supplies**
- Vaccines**

Bird-in-Hand
pet structures™

470 Millwood Rd. Willow Street, PA 17584

PH: 717.435.8222 Fax: 717-435-8386

Mon.- Fri. 6am - 5pm

We Ship 9-5 & UPS

PETS

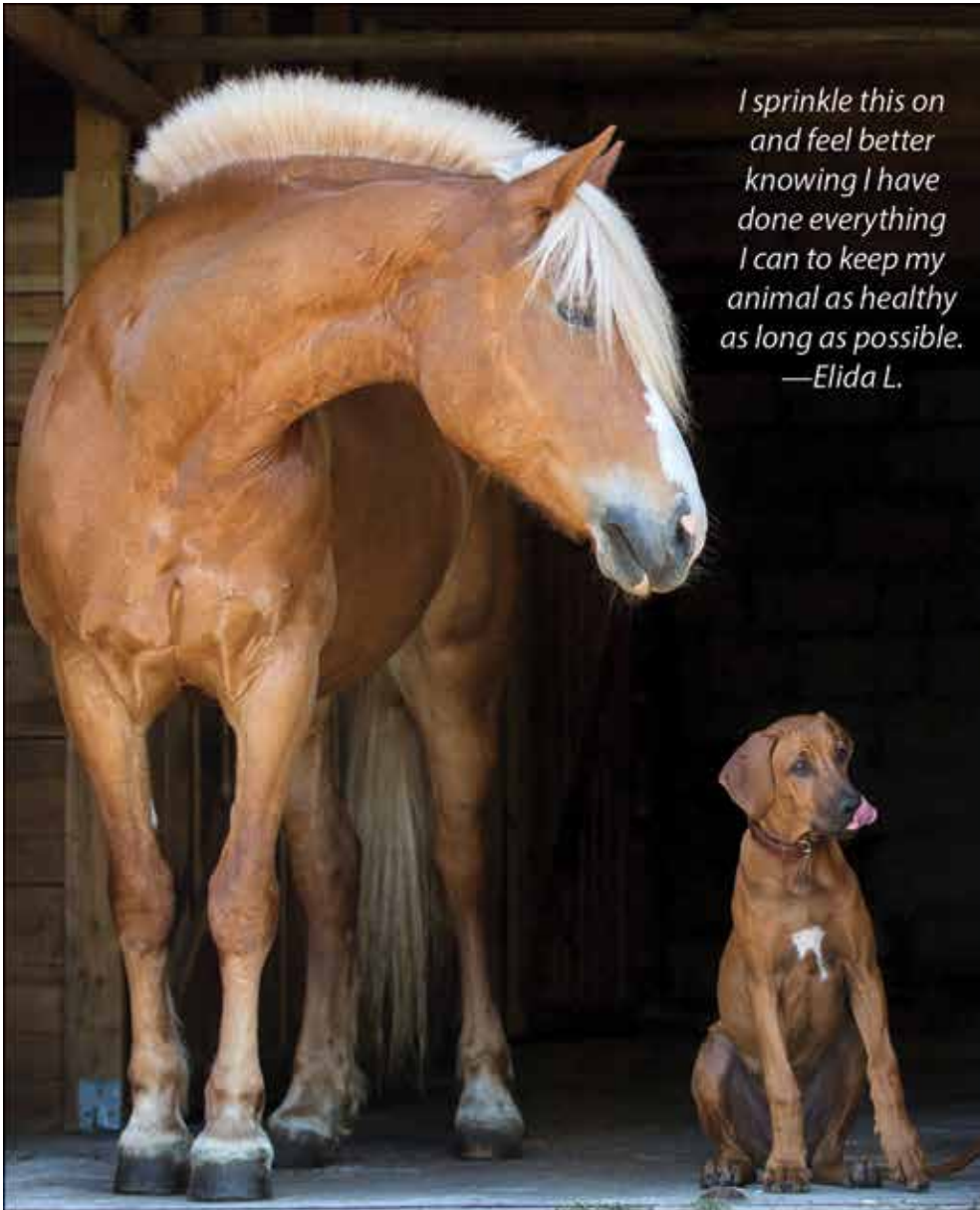

*I sprinkle this on
and feel better
knowing I have
done everything
I can to keep my
animal as healthy
as long as possible.
—Elida L.*



Pet-Crumbles

For Dogs and Cats

A health supplement with Aloe Vera, Glucosamine, Yucca Shidigera and Probiotics. Helps support a strong immune system, gut health and joint function.

Horse Pellets and Aloe Gut

When you want the best for your horses provide them with the extraordinary benefits of Pharm-Aloe to support their GI health, immune system, aid the balancing of stomach pH, support normal detoxification and normal inflammatory response processes and reinforce cellular communication.

**Helps reduce
ulcer's and colic!**



To place an order contact your Michiana Distributor
Michiana Aloe Sales • 269-503-0014
 Attention: Ervin & Rosemary Mast
 32251 Hagelgans Road • Burr Oak, MI 49030

CHUPP BROTHERS
Wholesale
Hardware & Tack

TO PLACE AN ORDER, CALL
260-499-0525

SHIPPING AVAILABLE!

OR PICKUP YOUR ORDER AT:
890 S VAN BUREN ST, SHIPSHEWANA
MON-FRI 8:00-4:30

PREMIUM SALE OR SHOW HALTERS

NEW!
NEW!
NEW!

\$49



3/4" Bio Halter
Standardbred or Yearling
Brass-plated hardware and name plate

\$49



1" Leather Halter
Standardbred or Yearling
Brass-plated hardware and name plate

\$49



3/4" Bio Halter
Standardbred or Yearling
Stainless Steel hardware and Chrome name plate

\$69



1" Oiled Premium Leather Halter
Standardbred or Yearling
Stainless Steel hardware and Chrome name plate

*Customized
 Brass-plated or
 Chrome name
 plate to match the
 halter hardware!*



NEELY DUNN - RED OAK'S LORETTA - SIERRA KOSMOS

Noble King



Ink Scape

**BLACKMOORE
FARMS**
TRAINED BY (989) 370-3812

Cedar Grove Stables

\$1000 Service Fee
shipped semen available

(989) 386-4196
call for terms

Your Custom Seating Solution

Buggies | Cruisers | Autos | Marine

We Build:

- Cruiser Bucket Seats w/Center Console
- Buggy Bucket Seats
- Open Wagon Seats
- Pony Cart Seats



Options:

- Cloth or Vinyl Seating
- 2-Tone Seats
- Coil Spring Seating
- Center Pullout
- Ask About Nearly Unlimited Options!



2-Tone Cruiser Bucket Seat Option



Center Pullout w/Center Console

Wholesale and Retail options available.
Call 269.221.0016 for details!



J & L Buggy Shop

Joas & Liz Hershberger | 64280 Balk Road | Sturgis, MI 49091

P: 269.221.0016 | F: 269.222.9160 | E: jandlbuggysshop@ibyfax.com

CRAFTED FOR YOUR JOURNEY

Lifetime Warranty on Coil Spring Frames for Buggy Seats

FOAL NUTRITION CARE



TRANSITION PELLETS

- Milk-Based Ingredients
- Essential Vitamins & Minerals
- Protein & Fat Balance



MILK REPLACER

- Essential Nutrition for Foal Growth
- Protein & Fat Balance
- Highly Digestible Formulation



SHIPPING AVAILABLE



OFFERING WEEKLY DELIVERY
CALL US! (260) 768-4837

Shotgun Charlie

DJ's Swan by Andover Hall x Kadabra

DOB: 05/11/2022

Service Fee: \$800



Photos and Design by [Dominiqueart.com](http://www.dominiqueart.com)

SHOTGUN CHARLIE



Standing at Evergreen Stables.

14488 CR 38, Goshen, IN 46528 | (574) 642-4414

LFG | SHIPPED SEMEN AVAILABLE

Owned by Daryl Yoder 7990 N 450 W Howe IN, 46746 | (260) 585-4260

Presented by C-Mor Equine



Well Expressed x Stdb
Three year old mare.
Sold in spring Waky 2024
for \$7600

Well Expressed is exceeding our expectations
as a breeding stallion. Watch for his offspring in
the spring sales!

Three year old gelding
Well Expressed x Pony
Sold at 2023 Chupps Sale
for \$10,500

Four year Well Expressed x Smokey 2
Sold in spring Waky spring 2024
for \$10,700

Three year old gelding
Well Expressed x Pony
Sold in fall 2023 Waky
for \$7000

Well Expressed x Paint Pony
Yearling Mare
Sold in spring Waky fall 2024 for \$2300

Two year old gelding
Well Expressed x Pony
Sold for \$5250 at the
fall 2024 Waky Sale.

WELL Expressed

Mr Donewell x American Express by Hostline Dufus

Service Fee: \$500 - Shipped Semen Available - LFG

1 year Return - Multiple Mare Discount

A rare opportunity to breed to an ITPA Registered Standardbred x Race Pony Stallion.

Stands 58" Tall

Co-owned with

Clarence Bontrager 765.395.9053

RAMERS RANCH

67071 CR 7 | Wakarusa, IN 46573 | 574.862.1284



Master Key Sales

UNLOCK THE NATURAL POTENTIAL

13468 SR 4 Goshen, IN 46528 | PH: (574)536-9400 Fax: (574)336-3445

Breeding Supplies



Non-GMO Horse Feeds, shavings and bedding

The MARE Monitor logo is also visible at the top right of the equipment display.

Call today to request a free catalog with our complete line of products!



Specializing in:
NATURAL PRODUCTS
FULL LINE OF REPRODUCTION SUPPLIES



HORSE WALKER

BY R-FACTOR ENTERPRISE



HORSES

CALL FOR DETAILS
740-722-2240

NUTRA-GLO™

NUTRITIONAL FEED SUPPLEMENTS



- ☀️ Weight Gain
- ☀️ Haircoat
- ☀️ Hoof Quality
- ☀️ Muscle Tone
- ☀️ Stamina
- ☀️ Immune System
- ☀️ Reproduction
- ☀️ Actual Health
- ☀️ Consistency



The 1st Choice Supplement
of hundreds of today's Horse Owners,
Dairy Farmers, Veal & Poultry Producers
and Deer & Dog Breeders!



Runs \$9-12/horse/month

For more information contact your area Distributor:

— Michigan Distributor —
Michael & Kristina Gingerich
1258 N Mt Tom Rd
Mio, MI 48647
989 • 848 • 2588

—Northern Indiana Distributor—
Dale Bontrager Family
11570 W 600 S
Millersburg, IN 46543
574 • 642 • 0177

—Southern Indiana Distributor—
Healthy Choice
(Matthew & Vera Wagler)
10781 N. 1080 E. • Odon, IN 47562
812-787-2983 or 812-636-1800

Also available for Ruminants,
Dogs, Poultry, and for Swine.



THE CANADIAN KIND

Brazen x Kadabra - American Winner
Service Fee \$1000
#4NR55

photo and design by sumerigins.net

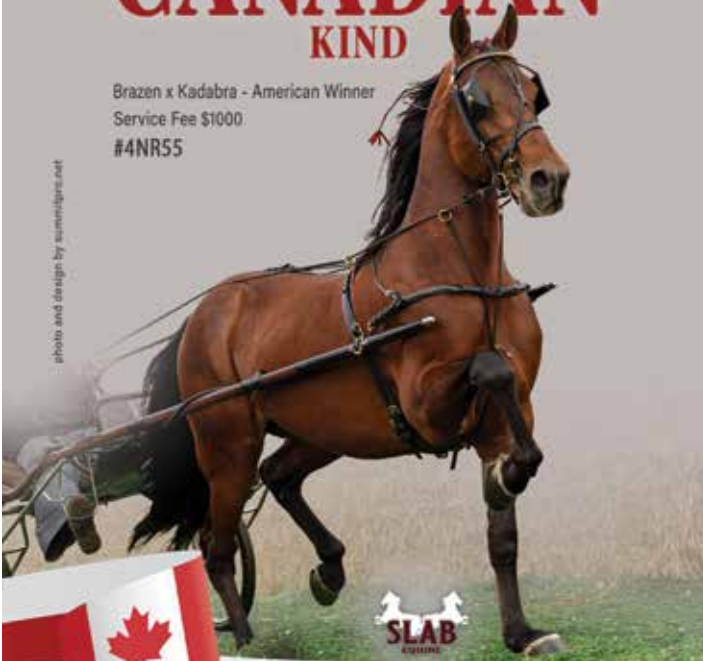

Standing at SLAB Equine - LaGrange, IN (260) 350 - 7140
Owned by The Canadian Kind Partnership (989) 528 - 8304

Tragic buggy or car accidents can happen. Reid Yoder has helped Amish families for decades when they are in need. Insurance companies may try to take advantage of you. Let Mr. Yoder protect you and your family during these difficult times.



Mr. Yoder understands the Amish lifestyle and traditions. He will help you with your medical bills and insurance related issues. Contact Mr. Yoder and he will help.



REID YODER
330-329-1157



Automatic drinker ideal for all types of livestock.



WOW!
There's the Dura
Drinker you've
been telling
me about!

\$410.00

User friendly design allows for easy cleaning and service of the drinker.

Featuring a unique tub design with valve protection, high efficiency float valve and extreme freeze resistance. Extremely durable construction. Virtually maintenance free. No gas or electric wires to cause potential shock. Will not rot or rust. Can be used for all size animals.



FEED CART

Hard rubber wheels, top dress compartments, gas cylinders for lid, aluminum frames. Standard w/cylinders
200 lbs. capacity.....**\$565.00**
300 lbs. capacity.....**\$598.00**
500 lbs. capacity.....**\$690.00**
Mineral Boxes.....ea. **\$19.00**

KENNEL CARTS

2 & 3 compartment feed bins, riser on lid for multipurpose work surface, lightweight aluminum frame, hard rubber wheels, gas cylinders for lid
2 - Bin Cart.....**\$516.00**
3 - Bin Cart.....**\$562.00**

FARRIER CART

Heavy duty 3" casters, nailboxes w/sliding lids, pistol Grip Standard w/Pistol Grip Handle (Best Seller).....**\$305.00**

TACK BOX

Pushes like a wheelbarrow, hideaway handles, halter hooks, gas cylinders for lid
Standard w/cylinders grey w/white trim.....**\$575.00**
Large w/cylinders (6" longer).....**\$610.00**

DELUXE TACK BOX

Efficient storage space with convenient front drawer, sturdy rubber caster wheels, folds for ease of stow and go, gas cylinder lifts on lid
Deluxe Harness and Tack.....**\$839.00**



Distributed by:
Keystone Sales
717-715-3498
332 Hollow Road
Quarryville, PA 17566
Dealer inquiries welcome.
Call for wholesale pricing.

DURA BOWL



IT'S NOT YOUR AVERAGE BOWL!

Unique features include a larger deeper bowl, stainless hardware, extremely durable construction that is designed to stay cleaner and it easily mounts in cow and horse barns.



\$67.95

Kit Includes: Dura Bowl, stainless hardware, stainless attaching bracket, high flow valve.

INDIANA SWAN

Swan For All x Belville by Yankee Glide
DOB: 04/10/2017
Service Fee: \$800

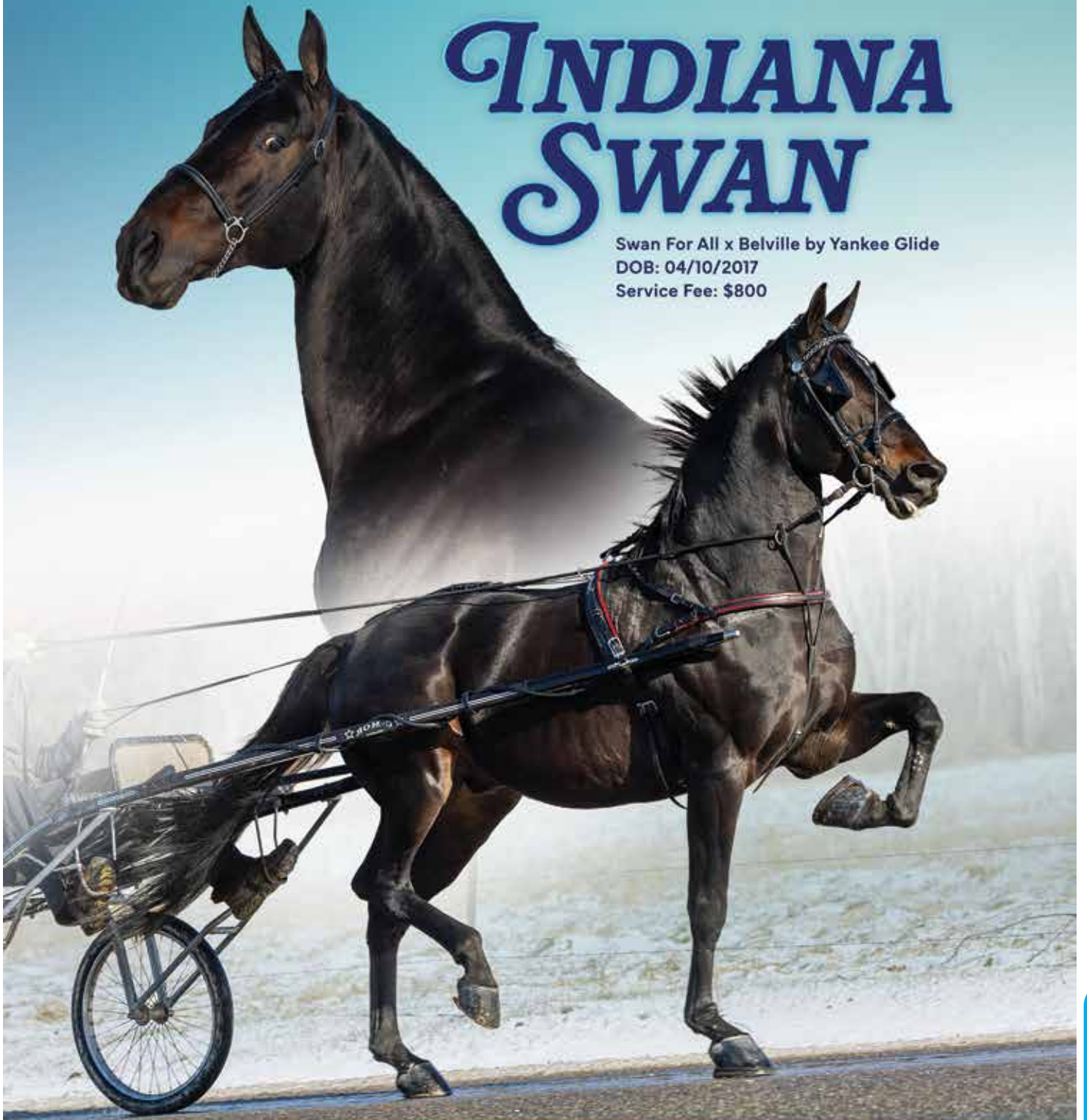

Photos and Design by Sammiepro.net



Standing at Evergreen Stables
14488 CR 38, Goshen, IN 46528 | (574) 642-4414
LFG | SHIPPED SEMEN AVAILABLE
Owned by Indiana Swan's Investment Group
Presented by C-Mor Equine

Consigned to the Mid-Ohio Pony Sale March 9th 2026

Contact Memory Lane Equine for videos and more information.



MEMORY LANE Melvin Stutzman | Phone: 330-600-2797 | Email: sunsetacrefarm991@gmail.com

IN FOAL TO PSR VOLT OF LIGHTNING

Rides & Drives - Parades, Parties & Trails
Calm, Kind, Kid and Beginner Friendly
Smooth Galts



SD ROSE AND ROSES

SD The Man x European Stock
2020 GVHS Black Sabino Mare
PSSM 1 & FIS Negative • 12.2 Hands



MLE MARBLE'S FANTASY

Picasso's Masterpiece x SD Marble
2025 Filly - PSSM 1 & FIS Neg.
Expected Mature Height 12 Hands
Color tested: A/a, E/E, D/nd2, W32/n,
SB1/n, EXDW1/n, EDXW3/n



SIRE: ROYAL FLEX DAM: BY DEWEYCHEATUMNHOWE

#9SA62 - D.O.B. 4/30/2018

DEWY JUSTICE



SIRED BY DEWY

Owned by:

NEXT LEVEL STABLES
Elmer S. Stoltzfus & Daniel Stoltzfus - Gap, PA
(717) 314-7299
Call for more information and bookings.

Standing At:

MILLWOOD
EQUINE
Gap, PA
On-Farm Breeding - Shipped Semen

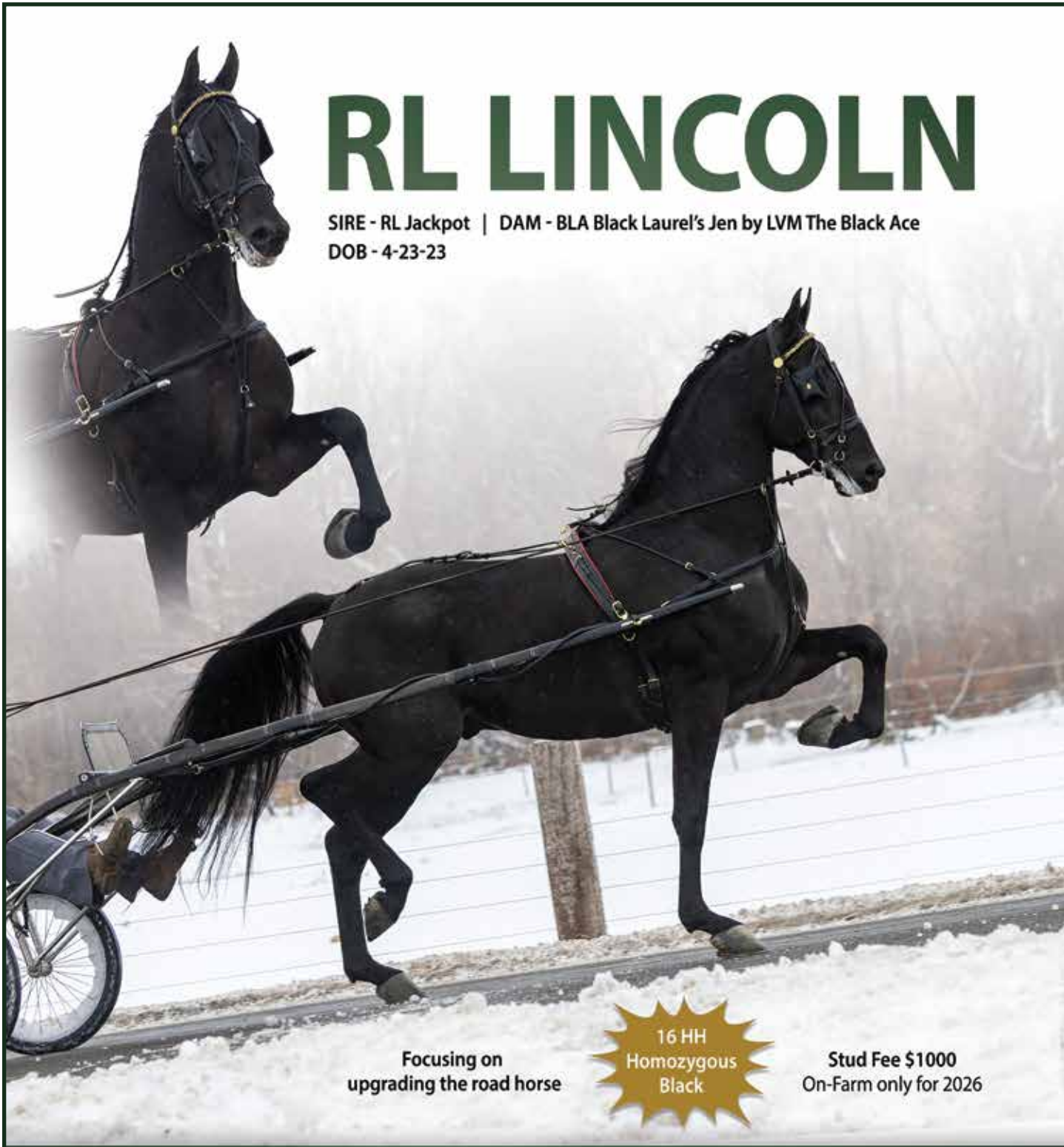

RL LINCOLN

SIRE - RL Jackpot | DAM - BLA Black Laurel's Jen by LVM The Black Ace
DOB - 4-23-23

Focusing on upgrading the road horse

16 HH
Homozygous Black

Stud Fee \$1000
On-Farm only for 2026

TRAINED AND PRESENTED BY:



STANDING AT:

RL Morgans
Ryan & Doretta Lambright
63557 CR 31, Goshen, IN 46528
(574) 642-4989

HORSES

Newton THUNDER

4/12/2020 • Stallion • 8V804
Newtown Choclatier - Cray-Cray - Crazy
(2nd dam by Muscles Yankee)

HILTY ACRES
Equine

Prepped by Hilty Acres Equine, 260-258-6776
Standing at Coblenz Family Farm, 574-642-1180
Owned by Newton Partnership, 260-223-5237
Driving photos will be available in the future. Newton has been recovering from injury and is now back in training.

Service Fee \$600
(\$100 due at breeding, \$500 when foal is born or \$500 up front)
Multiple Mare Discount

HAY SAVERS

Tired of wasting Hay when Feeding Outdoors.
Feeders are great at saving HAY.

HORSE STALLS

We have Standard Stalls in Stock
We have many options to fit your barn.

Available w/o Roof

SUNSET EQUIPMENT

4390 S 500 W Topeka, IN 46571
PH: (260) 593-9158 x1 Fax: (260) 593-0257

Black ACE

SANDOKAN (DHH) X RACING TROTTEBRED PONY

Service Fee: \$500 - Shipped Semen Available - LFG
1 Yr Return - Multiple Mare Discount

Ace is homozygous black. He stands 60" tall and is that handy buggy pony size. Black Ace is a small stallion but has a big motor! He is well broke, Has a sweet disposition, And a lot of drive. If you want to raise that popular buggy pony or a smaller horse, consider ace he is ADHHA registered making him an excellent choice to downsize some of the big dutch crosses and still raise ADHHA registered offspring.

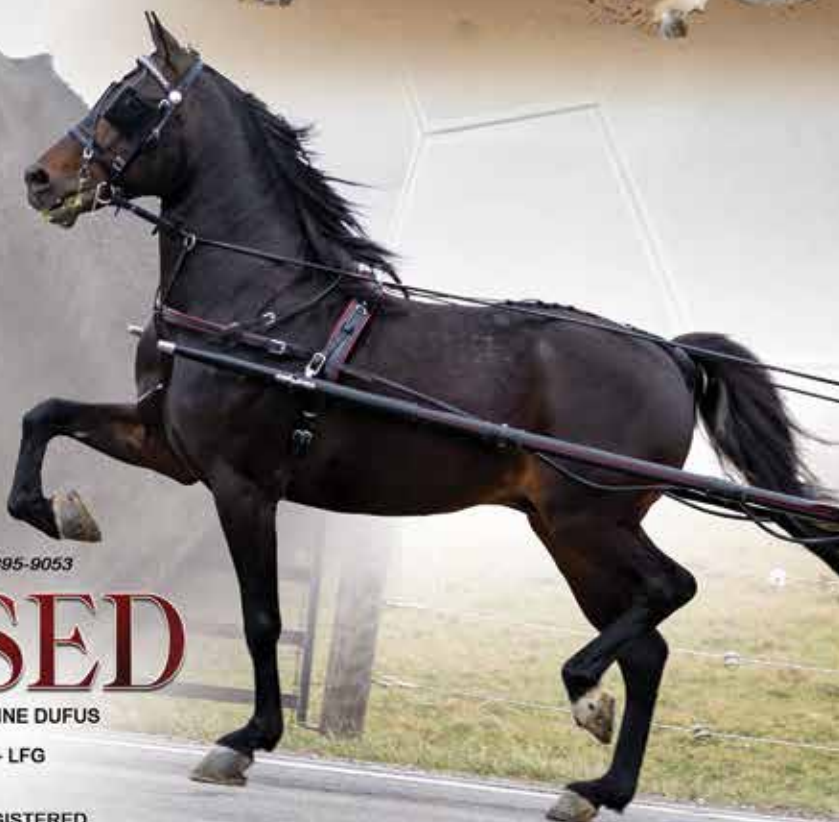

Well

Co-owned with
Clarence Bontrager (765) 395-9053

EXPRESSED

MR DONEWELL X AMERICAN EXPRESS BY HOSTLINE DUFUS

Service Fee: \$500 - Shipped Semen Available - LFG
1 Yr Return - Multiple Mare Discount

A RARE OPPORTUNITY TO BREED TO A ITPA REGISTERED
STANDARD BRED X RACE PONY STALLION. STANDS 58" TALL

Standing At:

Ramers Ranch

Contact Josiah & Kathleen Ramer for more information
67071 CR. 7 • Wakarusa, IN 46573 • 574-862-1284

April Schuler



PSR VOLT OF LIGHTNING

2022 Black GVHS/IGEA Stallion | SD Sky's the Limit x SD Miss Equissitt
Pssm 1 & FIS Neg. | E/E, w20/w20, a/a | 12.2 Hands Mini Gypsy

Consigned to the Mid-Ohio Pony Sale March 9th 2026
Contact Memory Lane Equine for videos and more information.



MEMORY LANE Melvin Stutzman | Phone: 330-600-2797 | Email: sunsetacrefarm991@gmail.com

MAXIMUM PERFORMANCE HORSE SUPPLEMENT

Give your horse the minerals that are no longer in the your feed!

50 lb Bag Granular \$150, last 5 horses/ 1 month. 50 lb bag pellets \$135 last 50 days/ a

horse Pellets for picky eaters, with ulcers, driving horses, Stallions and mares.

Dave Mast mare was open two years in a row, 30 days on Maximum Performance and she checked in foal with NO Regu-mate.

David Patterson bred for 30 years and always trouble foaling out, weak foals, trouble re-breeding. First season on MP, mare foaled easily, baby running in the stall, plenty of milk, mare cleaned quickly and checked in foal first time bred. Very impressed.

Indiana man had mare running off, cranky, picky eater, put her on pellets, 15 days daughter said, What did you do to the mare? She is so easy to handle, drives great, looks better. MP Pellets. oh my.

Lawrence Schrock, PA said he was one of the few with no OCD's in his yearlings at the sale, thanks Maximum Performance for sound bones, strong muscled yearlings.



Driving horses are under a lot of stress, many have ulcers, tendon issues, hoof problems. There are few minerals in your feed, and this supplement provides what they need to perform at their best, sweat less, warm up faster, reduce muscle soreness, and improve hoof quality and build muscle.

1. If you want to reduce ulcers, acid reflux and build muscle as well.
2. If you want to increase stamina and reduce recovery time, see a difference in 5 days..
3. If you want to calm your mares down, reduce tying up, anxiety and aggression.
4. If you want to enhance elasticity in tendons and ligaments and get nutrients to the hoof. May recover from injuries in half the time, soft tissue and bone.

Maximum Performance for Breeders

1. If you want to reduce OCD's (soft bone chips in ankles and hocks).
2. If you want to have mares at peak condition checked in foal.
3. If you want to improve development of your foals.
4. Vets explain OCD's are caused by mineral imbalance first 11 months in womb, not enough Calcium and minerals for the mare.
5. Stallions have better sperm count, maintain muscle mass, reduce OCD's and maintain hoof quality. **contact 502-817-1947**

WISCONSIN CALL 502-749-1695

ACE OF SPADES

52" black & white pony stallion

**2026 BOOK IS OPEN
& FILLING FAST**

Get your mare booked today!



SAMPLE OF OFFSPRING



standing at
Rolling Hill Stables
146 Rolling Hill Ln, Allentown, PA17002
(717) 250-5332
owned by Ace Partnership

Images by Jhara Media

**UPS
Shipping
Daily**

Yoder Blacksmith Supplies

**Ask For
FREE
Catalog**

Dedicated To Serving Our Customers!



**MADE IN
THE USA**



**Hershy Lane No 1
Insulated Horse Blanket**

Size

- 60-64-66 \$65.65
- 68-70-72 \$71.60
- 74-76-78 \$75.95
- 80-82-86 \$81.90

This is a good quality blanket for all around use, in the stable or outside. It is made of strong 600 denier waterproof top coat with a quilted lining. It is fitted across the back and is trimmed with white binding unless stated otherwise. It has nylon surcingles, two front closures are snap and D-ring. Completely washable. Colors: Royal Blue, Navy, Burgundy, Red, Black, Brown, Hunter Green, Gray, Purple.



**Hershy Lane No 2
Regular Horse Sheet**

Size

- 64-66-68-70 \$45.35
- 72-74-76-78 \$48.15
- 80-82-84 \$50.95

This sheet is made with breathable light weight fabric to absorb moisture off of the horse after workout or bath. Made with one girth strap, two front closures and elastic leg straps. Assorted colors.



**Hershy Lane No 6
Draft Horse Blanket**

Size

- 64-66-68 \$72.85
- 70-72-74-76-78 \$83.15
- 80-82-84-86 \$91.90
- 88-90-92 \$96.90
- 94-96-98-100 \$100.95

This blanket is a good quality blanket for all around use. It is made with strong 600 denier water proof top coat with quilted lining. It is fitted across the back and trimmed in white binding unless otherwise stated. Has one surcingle strap and elastic leg straps. Two adjustable front closures are 1 1/2" snap and D-rings. Colors: Red, Royal Blue, Navy, Burgundy, Black, Gray, Brown, Hunter Green, Purple.



**Hershy Lane No 3
Insulated Turnout Blanket**

Size

- 58-60-62 \$58.15
- 64-66-68 \$67.20
- 70-72 \$74.40
- 74-76-78 \$78.15
- 80-82-84 \$84.40

This blanket is made with the same material as No. 1. One belly strap and 2 front closures with 1" snap and D-rings with elastic leg straps. Comes in white trim unless you prefer black. Assorted colors.



**Hershy Lane No 1SHL
Shaft Loop Style Blanket**

Size

- 68-70-72 \$74.10
- 74-76-78-80 \$77.85

This blanket is the same quality blanket as the No. 1 Insulated Stable Blanket. Designed with a slit on the side, two nylon surcingle straps in the back to fit around shafts, also adjustable to use in stable. Two front closures are snap and D-ring. Assorted colors.

**Hershy Lane No 5
Draft Horse Sheet**

Size

- 60-64-66-68 \$50.95
- 70-72-74-76 \$54.40
- 78-80-82-84 \$57.85
- 86-88-90-92 \$61.60
- 94-96-98-100 \$64.70

This sheet is made with a strong tear-resistant breathable equifab material, with one girth strap, elastic leg straps, two adjustable front closures are 1" snap and D-rings. This material has a strong wicking ability to draw moisture off of the horse after workout or bath. Assorted Colors.

**Hershy Lane No 6HD
Heavy Duty Draft Blanket**

Size

- 60-64-66-68 \$98.15
- 70-72-74-76-78 \$103.70
- 80-82-84 \$111.90
- 88-90-92 \$117.80
- 94-96-98-100 \$123.75

This quality blanket is insulated and designed same as No. 6 Draft Blanket with a heavy duty 1000 denier cordura top coat. Has one surcingle strap, heavy duty leg straps and two front closures are 1 1/2" snap and D-ring. Colors: Hunter Green, Red, Royal Blue, Burgundy, Gray.



Shipping Rates (Zip Code Lower Than 67700)

	Shipping Cost
up to \$75.00	\$10.00
\$75.01 to \$150.00	\$15.00
\$150.01 to \$250.00	\$25.00
over \$250.00	FREE if invoice is paid in 10 days!

8900 TOWNSHIP ROAD 652 • FREDERICKSBURG, OH 44627

HORSES

LIMITED LIFETIME BREEDINGS AVAILABLE!

JASPER THE MAN

OU MAN X KEYSTONE FOREGO



LR JASPER PUMPKIN

2025 BREEDERS CUP FUTURITY **RESERVE CHAMPION**

SOLD PRIVATE FOR **\$50,000**



STANDING AT PLEASANT RIDGE EQUINE

TRAINED AND PRESENTED BY SLATE ACRES STABLES LLC

574.825.0218

A
&
M
'
S

LEONARDO

Dondersteen x JD's Alivia by Plains Liberator

\$200 discount if you book and pay by April 1

Thanks to Sterling Dreams for managing the stallion.
His oldest crop is 3 years old and driving.
They have the Dondersteen drive and look!

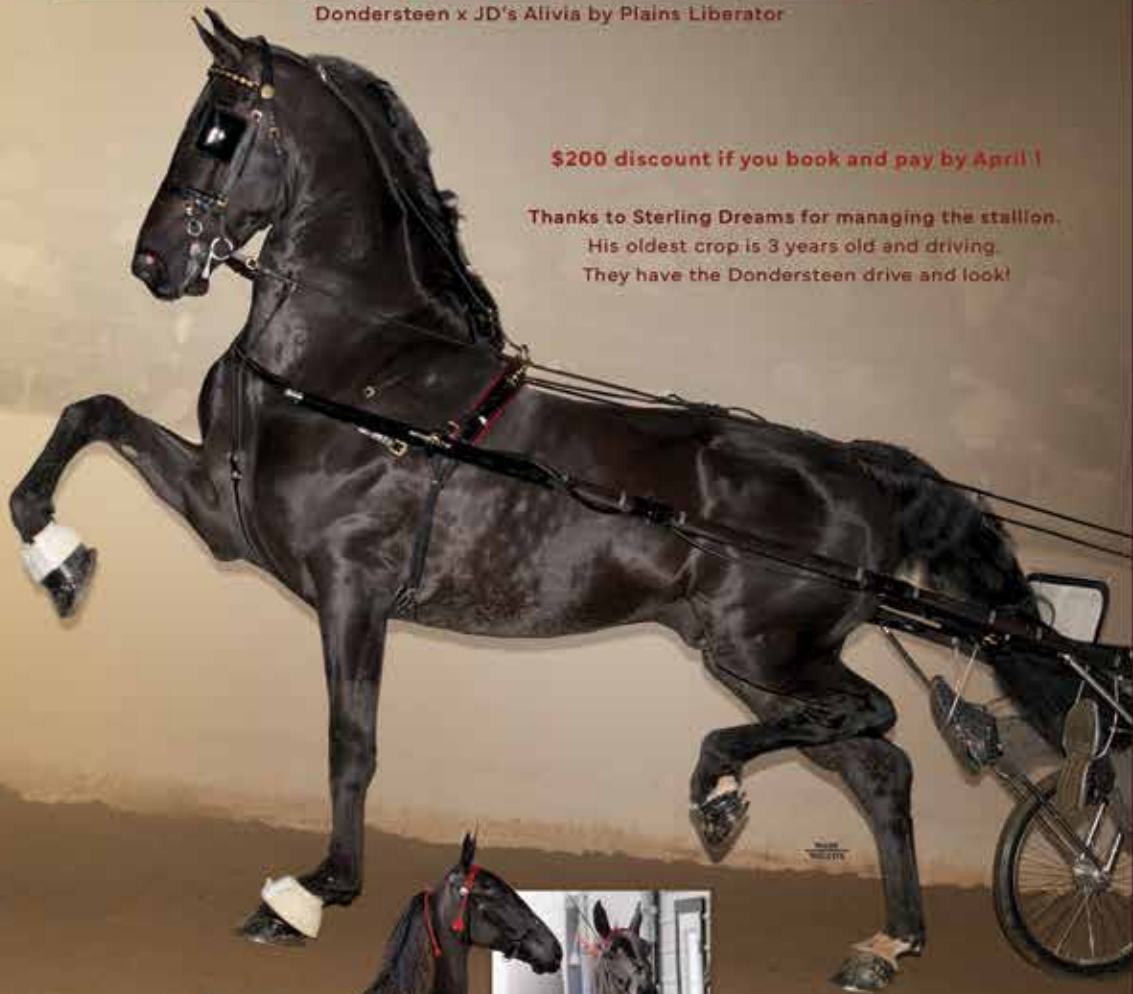

Filly sired by Leonardo and out of a Broadway Hall x Pine Chip. dam placed 2nd in the NPEC Futurity, Road Type.

Owned by Matthew Stuary
Trained & Presented by
Lamar Kochstetter
Middlebury Indiana 46540
(574) 384 - 0849
Assistant Trainers Mark Miller, Lyndon Bluck



Standing at Sterling Dreams
(574) 535 - 4887
sterlingdreams.com

Horse of a Different COLOR?



LET US **DESIGN & PRINT** YOUR NEXT PROJECT!

COLOR
Advertising WORKS!

brochures • flyers
greeting cards • magnets
posters • invoices
menus • wedding invitations

envelopes • banners
promotional items • labels
folders • yard signs
gift certificates

notepads • catalogs
booklets • door hangers
business cards
postcards • outdoor signs

19270 Scott Road
MT VERNON, OH 43050
740-397-0262
orders@pageonegroup.net



ARE YOU LOOKING FOR A FAMILY HORSE OR PONY?

Announcing an **On Farm Silent Auction** with horses from various local communities.

- Horses will be roadshod only
- Come test drive before purchasing
- Enjoy free food

APRIL 18, 2026 9:00AM



Held in Manton MI
Call Marcus **231-824-9741** or Gabriel **231-824-9825**

OFFERING YEARLING SALE PREP

AT OUR BRAND NEW FACILITY



WE ARE DEDICATED TO A DETAILED & THOROUGH APPROACH TOWARD FITTING, PROMOTING & PRESENTING EACH & EVERY HORSE TO MAXIMIZE THEIR FULL POTENTIAL & PRODUCE CONSISTENT RESULTS FOR OUR CUSTOMERS.



CONTACT US FOR A LIST OF SALES WE WILL BE ATTENDING IN 2026 OR TO RESERVE A CONSIGNMENT SLOT IN OUR LINE-UP.

323 MILL WOOD RD. - GAP, PA 17529 - (717) 314-7299

**2 Day
Auction**

**Don't
Miss Out
on This
Event**

**March
6th & 7th, 2026**

**SALE TIME:
8:30 AM**



**GRANGE PARK
CENTRE HALL, PA 16828**

**Grange Fair Grounds
169 Homan Lane
Centre Hall, PA 16828**



FRIDAY, MARCH 6TH

170 STANDARD BRED TROTTERS, MARES, GELDINGS, and STALLIONS
Some of the industries Finest to be sold under harness!

SATURDAY, MARCH 7TH • MORNING SALE

**20 TROTTING BRED, STANDARD BRED, YEARLINGS
20 TROTTING BRED MARES (In Foal)**

Followed by...

110 QUALITY DUTCH HARNESS and FRESIAN PURE BRED and CROSSBREDS
to be sold under harness!



***Thanks to our loyal consignors who are bringing
some of the best that they have ever brought!***

The Place to Be the First Week in March to Buy...
Personal Drivers, Quality Broodmares, or Potential Show Horses!

**You Don't Want To Miss
This Yearly Event...**

MID STATE
where it all comes together!

**...So Line Up Your Ride,
and Book Your Motel
Today!**

— Hotel in Boalsburg, PA - 5 Min. from Sale —
WYNDHAM GARDEN • 814-466-2255

— Hotels in Mill Hall, PA —
HAMPTON INN & SUITES • 570-726-3939
QUALITY INN • 570-726-4901
GRANDVIEW HOTELS • 570-726-4181

— Hotels in State College, PA —
RAMADA BY WYNDHAM • 814-238-3001
DAYS INN BY WYNDHAM • 814-238-8454
SUPER 8 BY WYNDHAM • 814-237-8005
**BEST WESTERN PLUS UNIVERSITY PARK
INN & SUITES • 814-234-8393**
DAYS INN BY WYNDHAM • 814-234-1600

— Nearby Motels —
HOLIDAY INN EXPRESS • 717-946-0777, Reedsville
SUPER 8 • 717-242-8888, Burnham
QUALITY INN • 717-248-4961, Burnham
CROWN MOTEL • 717-248-3315, Burnham
ECONO LODGE • 717-436-5981, Mifflintown

Committee Members - Call Willis Troyer: 717-535-5901 • Call Ephraim Miller: 814-571-1553



Mt Hope Bound

Tuesday, March 10, 2026

2 year old Bay Filly

Star • Two Whites • Sire: SD Rocketeer • Dam: Pine Chip • Tall, Stretchy, Pretty • Kinda Special

2 year old Black Filly

One White • Sire: Chromemaster • Dam: Jailhouse Jesse • Smart, Refined • Unreal Front End

2 year old Bay Stallion

*Star • Two Whites • Sire: Muscle Massive • Dam: Lou's Legacy • Big, Bold •
From a Great Trotting Sale Mare*

2 year old Black Bay Filly

*Very Talented • Sire: Sander Van't • Dam: Jailhouse Jessie x Pine Chip •
Full Sister to Show Horse Queen's Flicka*

1 year old Bay Stud

Small Star • Sire: SD Rocketeer • Dam: Majestic Son • 2nd Dam: Balanced Image • Prospect

1 year old Bay Stud

Star • Two Whites • Sire: Rev-N-Roll • Dam: Sir Taurus • Refined & Pretty • Nice Trot

ALL HORSES SELL WITH HARD COPY PAPERS AND NO RESERVE



Emanuel & Rachel Yoder
21100 Daniels Rd Mt. Vernon, OH 43050
419.571.2372 (work# 6a-5p)

8th Annual
North American

BUGGY PONY AUCTION
FRIDAY, MARCH 6TH 2026

STALLION PRESENTATION 3:00 PM • PONY AUCTION FOLLOWING
 MICHIANA EVENT CENTER • SHIPSEWANA INDIANA
 455 E FARVER ST, SHIPSEWANA IN 46565

Catalogs can be picked up at these local businesses: Eastside Harness • Millersburg Feeds • Master Key Sales
 FD Miller Feed - Middlebury • Shipse Farm Supply • Woodruff Harness • Diamond Harness - Nappanee
 To request a catalog through the mail, please contact Seth Miller



LOT 2



LOT 50



LOT 53



LOT 54



LOT 55



LOT 91, STDB MARE



LOT 81



LOT 29, STDB MARE



LOT 5, STDB MARE

2026 CONSIGNMENTS

SALE COMMITTEE

LONNIE KUHNS (260) 350-3787

SETH MILLER (260) 585-7256

LOREN BONTRAGER (260) 350-5467



LOT 145



LOT #20 - KING KOZ

PERRY COUNTY CONSIGNMENT & PONY AUCTION

Saturday, April 11, 2026 @ 8:00

Located at: 601 Shermans Valley Rd, New Bloomfield, PA 17068

Wanted consignments of,
Hackneys, school ponies, minis,
riding ponies.

Accepting consignments now till
March 7th, or till full.

All ponies must be cataloged.

Accepting approx. 130 ponies with a good selection of riding ponies, school ponies, & reproduction stock.

6%comm. on ponies w/ a \$100. min.& \$275. max.

Special mention, Already consigned!

- 3 yr. old black & white reg. fresian mare. 54"
 - 4 yr. old black & white mare. 50"
 - 3 & 4 yr. old black & white reg. fresian mares. 50". First sale. Full sisters. Sired by: Atticus
 - 8 & 9 yr. old black & white mares. 46". First sale. Full sisters. In foal.
 - 5 yr. old black & white mare. 46". In foal
 - 3 yr. old black & white mare. 46". First sale
 - 4 yr. old black & white mare. 41".
 - 3 yr. old black & white mare. 41".
- Plus, many more...

For more info call Mike 717-636-0686



Fall 2025 highlights
3 yr. old mare \$21,000.



Fall 2025 highlights
2 yr. old mare \$16,000.



Fall 2025 highlights
3 yr. old stallion \$25,000.



Fall 2025 highlights
3 yr. old mare \$20,500.

clip & save ----- clip & save ----- clip & save

Perry County Pony Auction Consignment form April 11, 2026

Consignor Name: _____

Address: _____

Phone: _____

Catalog description:
Size, color, age, comment.

Return this completed form now till March 7th
to: Mike Fisher 1750 Hominy Ridge Rd.
Newport, Pa 17074 (717)-636-0686



MARCH 4 2026

Located at
MAPLE COUNTRY FARMS
Formerly the Buster Miller Farm
Driving at 7am, Sale at 9am

1ST ANNUAL
Middlefield
STANDBRED AUCTION, LTD

PREVIEW OF CONSIGNMENTS | SALE IS NOW FULL!



34 GAILSCHROMESPOONS | 2023 M
Chrome Master - Here Comes Herbie



103 YOU KNOW DENA | 2022 M
You Know You Can Do - Yankee Glide



73 NL JUST THE GUY | 2023 G
Dewey Justice - Noble Venture



61 SHARP CURVE | 2020 G
Donato Hanover - Earl of Stormont



107 TEMPLE CITY | 2020 G
ABC Garland - Pine Forest



170 HD MELANIE | 2022 M
Rose Run Hooligan - Angus Hall



121 DOWNHOME PUNCH | 2020 G
Muscle Massive - Yankee Glide



69 MANNER'S MACHO | 2021 G
Mind Your Manners - Tagliabue



81 OU STACEY | 2020 M
OU Man - Angus Hall

ad by sugar bush design

HORSES





113 HARD ROCK CAFE | 2020 G
Rock of Cashel - Muscles Yankee



10 FATHER'S SECRET | 2021 G
Father Patrick - Muscle Hill



161 HONOR AND ROYALTY | 2021 G
Royalty For Life - Kadabra



48 VICTORY STORMONT | 2021 G
Ucandolt - Stormont Bronze



55 OU NORRIS LADY | 2015 M
OU Man - Minister of Doom



136 TRAPPER MAN | 2019 G
What The Hill - Tom Ridge



86 PHANTO'S CHARMS | 2023 G
Royalty For Life - Angus Hall



72 KEYMAN S. | 2021 G
Classic Grand Cru-Andover Hall



18 JAY RICHARD NYCE | 2021 G
Nuncio - Muscle Massive



35 NEWTOWN CHRYSLER | 2023 G
Newtown Chocolatier - Crazyed



127 VICKI'S ALL STAR | 2023 G
In Range - Valley Victor



28 SEMINOLE MOON | 2020 G
Shibboleth Hanover - Donerail

General Information:
David Troyer, 440-321-3515,
troyerstandardbreds@gmail.com

**Vendor Spots
and Advertising:**
Merlin Wengert,
440-897-7975

Auctioneers:
Dale Chupp & Andy White
Pedigrees:
Stephen Yoder & Atlee Shetler



SCAN TO
VIEW
CATALOG



9th Annual Tri. Co. Draft Sale

Friday February 27th, 2026.

10:00 AM.

Expecting 30 plus head of mules and 60 plus horses of probably the best line-up we have had. Some good working teams and some nice broodmares.

The catalog starts hitting the mailboxes on Feb. 6th. If you want one and didn't receive it by Feb. 13th Call Jake: 765-847-1690.

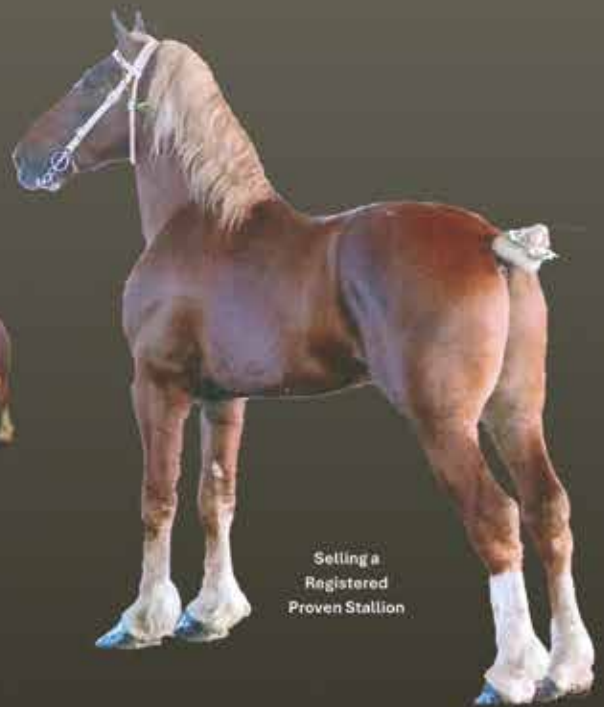

Selling a
Registered
Proven Stallion

*A big "Thank You" To all the Participants in our previous sales!
Also, we are prepping for our next colt sale in Dec. 2026.*

CENTRAL ILLINOIS STANDARD BRED AUCTIONS UNCATALOGED HORSE SALE

March 7, 2026

Held at Schrock Equine

163 N. County Rd. 200 E.

Arcola IL 61910

DRIVING STARTS AT:

7:00 am

SALE STARTS AT:

9:00 am

AUCTIONEERS:

Dale Chupp
Calvin Raber



Expecting a nice line of horses ready to go home to be your personal buggy horse!



Nice selection of young prospects

We will have sheets available day of sale with pedigrees and recommendations. To be on that listing have your consignments in by noon on Thursday, March 5, 2026.

ALL HORSES MUST HAVE CURRENT COGGINS

**ALL OUT OF STATE HORSES MUST HAVE
CURRENT COGGINS AND HEALTH PAPERS**

**BREAKFAST BY A LOCAL SCHOOL
LUNCH STAND OPEN ALL DAY**

For more information or to consign call:

Bennie Schrock Phone: 217-543-2266 Fax: (217) 543-2286

163 N. CR 200 E. - Arcola, IL 61910

Consigned **North American**
 ★★ ★★  ★★ ★★
Geldings **BUGGY PONY AUCTION**
 Friday, March 6, 2026



Jazz **4 years old**
Lot #12



3 years old
Lot #140 *Ace*
 Owned by *Eric Beachy*



Eody **6 years old**
Lot #88



Jasper
3 years old
Lot #119

Consigned & Owned by

Kenny Miller 574.238.2138

Jerry Bontrager 574.536.1651

Consigned Mares

North American BUGGY PONY AUCTION

Friday, March 6, 2026

Holly

3 years old
Lot #37

A Touch Too Much

3 years old Lot #43
Owned by *Eric Beachy*

Roxy

4 years old
Lot #51

Consigned & Owned by

Kenny Miller 574.238.2138

Jerry Bontrager 574.536.1651

5194 Ewing Rd. Ewing, Ky 41039

Spring Spectacular Riding Horse Sale

Top Seller Prizes **Top Buyer Prizes**
- (Best Ever Pad + More) - (Custom Buckle + More)

2025 Top Seller \$26,500



Consignment Information:

- \$50 Catalog Fee
- 10% Commission
- \$50 No Sale Fee

Contact Colton Ramey
(606) 748-9009

March 21st

Tack **Horses**

10:30 am **12:30 pm**

Online Bidding Available
@DVAUCTION.COM

MID OHIO PONY SALE BOUND! March 9 · Mount Hope, Ohio

Refined 2021 Friesian Pony Stallion

By **WOPKE**, out of a 50" Paint Pony Mare
56" Registered Friesian Sport Horse

LOT 92

Hillcrest
CHAMPION

Matt & Josh Hershberger
330-600-5847
Walnut Creek, Ohio

ALSO CONSIGNED

LOT 272 **EMBER**, 2021 Pony Mare, confirmed in foal to Hillcrest Champion



NORTHERN INDIANA GAITED HORSE AUCTION

FRIDAY, APRIL 17, 2026

Smooth Gaits • Quality Horses • Selling Live



\$100 ENTRY FEE
 + 7% SALE COMMISSION
No-Sale Fee: \$150

📍 Shipshewana Miscellaneous Building
 345 S. Van Buren St.
 Shipshewana, IN 46565

————— Sale Committee —————
 Duane Yoder: 574-238-2122
 Anthony Miller: 260-350-9143

🕒 Auction Begins at 5:00 PM
 Stallion Presentation at 4:30 PM



For More Info
 574-354-7304



Follow us on Facebook!
 Northern Indiana Gaited
 Horse Auction

**NOW ACCEPTING ANY GAITED OR RACKING HORSES,
 INCLUDING PONIES & MULES**

For Consignment Forms Call/Text Jen at **574-354-7304**



4 yr old Reg. AQHA Gelding

March 11, 12, 13, 2026

BOONE COUNTY

Draft & Quarter

★ HORSE SALE LLC ★

Missouri State Fairgrounds, Sedalia MO



4 yr old Reg. Spooks Gotta Spark Mare



5 yr old Reg. Gypsy Vanner Gelding

We'd like to invite you to spend a week in the Heart of Missouri. With 722 horses and mules in the catalog. This is definitely a must go! A big Thank-You to our consignors for an amazing set of horses coming! Feel free to reach out with any questions. Unable to attend bid online with DV Auctions or contact us for phone bids.

God Bless, Joe & Lonnie



5 yr old Reg. Gypsy Vanner Stallion



2 yr old Reg. Spooks Gotta Whiz Filly

Schedule:
 Wednesday March 11th -
 Tack, Antiques, Carriages,
 Harness, Collars, Saddles, etc.

Thursday March 12th -
 Draft Horses, Draft Crosses,
 Friesians, Gypsies, Haflingers,
 Ponies (smaller)

Friday March 13th -
 Quarter Horses, Quarter Ponies,
 Light Teams, Gaited Horses,
 Mules & Donkeys



7 yr old Perch/Qtr Cross Gelding



5 yr old Reg. AQHA Gelding



5 yr old Reg. AQHA Gelding



4 yr old Pony Gelding



8 yr old Registered Friesian Stallion



4 yr old Pony Mare



4 & 5 yr old Belgian Geldings



3 yr old Perch/Qtr Cross Geldings

Contacts
 Joe Raber - 719-431-3137
 boonecountyhorseauction@gmail.com
 Lonnie Miller - 260-350-4637
 lrmiller5717@yahoo.com

www.BooneCountyHorseSale.com

Highland Trixter x
Lockkeeper

Lot 5



Lot 15



Bar Hopping x
Andover Hall

Guccio x
RC Royalty

Lot 30



Consigned
Mares

Lot 105



Muscle Through It x
Yankee Glide

Enjoy Lavec x
Broke Even

Lot 65



Lot 160



Indiana Swan x
Sailhouse Jesse

These Mare Consignment Buyers enter a drawing for a FREE BREEDING to



MTB **FREIGHTLINER**

Four Stars Robro x Meantrotnjean by CR Commando
2023 Stallion Service Fee \$1500



Est. 2020

Rumbling Acres

Ryan Bontrager
260.593.0864





Wildlife Paradise Seminar



Learn how to build your own!

Bucks shown are 2 of 20+ bucks shot on Reuben Jess properties.

Tony LaPratt and Reuben Jess team up for a special, 2-day event! Ultimate Whitetail hunting & fishing bootcamp on 187 acres with a river, pond and woods showing all examples.

Seminar dates Mar. 20-21 AND April 17-18 2026

Bucks shot on Reuben Jess properties.



Were You Disappointed In Your Hunting Season?

1. Why would you spend a dime on another new bow or hunting blind, when it makes no difference in your hunting time?
3. Why would you buy more land when you have no plan, on how to have more deer on your land?
5. How about letting me show you how, to have so many deer you say, "oh my!WoW!"
6. Let's set up your land to be its best, so your hunting and fishing can be blessed.
7. All these small things can happen on as little as ten acres.

To RSVP call:

Event Location:
498 N CR 400 E
Arcola, IL 61910

Reuben Jess 217-402-3141
Reservations only - limited space available

Lodging:
Green Mill Village
917 Green Mill Rd
Arcola, IL 61910
Ph: 217-268-5000



CALL FOR FREE CATALOG!
814-427-2710 VM

STORE HOURS

Mon & Wed 8 AM – 7 PM	Tue & Thur 8 AM – 4:30 PM	Fri 8 AM – 5:30 PM	Sat 8 AM – 3 PM
-------------------------------------	---	------------------------------	---------------------------



MILLENNIUM TREE STANDS



CROSSBOWS



THERMAL IRAY SCOPES
In Stock



COMPOUND BOWS
HOYT • MATHEWS
MISSION • BEAR



TRAIL CAMS



214 LAKEVIEW DR • PUNXSUTAWNEY, PA



Unmatched lineup of proven authors,

- Bobby Worthington
- Alan Foster
- Joe Miles
- Wes Delks
- Dr. Bronson Strickland
- Jake Ehlinger
- Sam Collora
- Derek Borkholder
- Don Higgins and more...

Bi-Monthly Magazine Don Higgins, Editor	Writers guidelines: Don Higgins don@whitetaillife.com	Article submissions: Derek Borkholder derek@whitetaillife.com 800-414-0686	Advertising: Joas Yoder joas@whitetaillife.com 574-399-0424
---	--	--	---

Whitetail Life Subscription Form

Name: _____

Address: _____

Phone: _____ Fax: _____

Email: _____ Signature: _____

Subscription:
USA:
\$19.99 1 year
\$37.99 2 years
Canadian:
\$49.99 1 year
\$97.00 2 years

Bi-Monthly Magazine:
6 Issues Per Year
Your subscription will automatically renew with the payment method provided unless you cancel it.
 Check box to cancel auto renew

PAYMENT INFO: INV # (office use only): _____

Check# _____ AMT: _____

Type of card: American Express Visa MasterCard Discover

Credit Card#: _____

Name (as it appears on the card): _____

EXP: _____ CVC CODE (on back): _____

Phone #: _____ (required for credit card use)

Mail this form and payment to:

Whitetail Life
PO Box 3
Charm, OH 44617

Call 330-204-9199
with credit card information

email this form to:
sales@whitetaillife.com

**5% DISCOUNT
ON ANY DIY
PURCHASES**

YOUR ONE STOP SHOP FOR ALL PONTOON/BOAT NEEDS



ELITE COVERS & INTERIORS LLC

630 S 375 W LAGRANGE IN
260-214-0518

OPEN HOUSE
MARCH 20 12:00-7:30
MARCH 21 7:00-2:00



**AQUA-DANCE
CUSTOM PONTOONS**

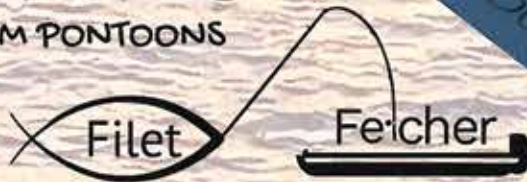

~ Aqua D-Lite ~

REFRESHMENTS



**WILL BE
SERVED
BOTH
DAYS**

**FREE
TRAVEL COVER ON ANY
TRITON/PONTOON
ORDERED AT
OPEN HOUSE**

The *ONLY MINERAL* that has over 90 sea minerals resulting in more robust bucks, does & fawns!!
Expect increased antler growth through nutritional genetic expression!



**Feed Minerals, Not Just Salt, Now For The Future...
 Feed OVER-160... More Robust Does & Fawns
 Which Will Be Your Future Target Buck!!**

- 7 Reasons To Consider Feeding Over 160 Minerals**
- ☞ Powerful Toxin Binder That Works Immediately to Flush Out Toxins & Parasites.
 - ☞ Sea-90 Trace Mineral Salt Containing Over 90 Sea Minerals for Maximum Health.
 - ☞ Humic Acids, Check Out The Research On How It Effects CWD.
 Bio Available Humic Acid Ingredient affects CWD. National library of medicine <https://www.ncbi.nlm.nih.gov/>
 - ☞ Not Just Salt, Highest Concentration of Vitamins & Minerals on the Market.
 - ☞ Expect Increased Antler Growth Through Nutritional Genetic Expression.
<https://extension.msstate.edu/publications/the-role-genetics-and-nutrition-deer-management>
 - ☞ Over 160 Daylight Contains a Proprietary Deer Activating Blend of Ingredients Formulated to Keep Bucks More Active During Daylight Hours.
 - ☞ Bottom Line is.... Stronger, Healthier, and More Robust Bucks, Does, and Fawns!!

ANOTHER BRUISER FOR THE WALL!!
Congratulations to Danny on landing this nice 8 point 144" MD Buck after feeding OVER-160 all summer!!



Disclaimer: Always check federal, state, and local hunting regulations before using this product. It is the user's responsibility to check by state regarding feeding or baiting of deer.

Dealer
 Inquires
 Welcome.

Oregon Ag LLC, 1150 E Oregon Rd., Lititz, Pa, 17543
 717-656-0067 info@oregonagllc.com

Available at
 Agri-Tonic
 Dealers



**At Midwest Sportsmen Classic
February 19th - 20th - 21st at the Mec!**

10% off

Off all 360° products!

**Plus! We will throw in Shelves,
Bow hanger and 360° 8oz.
Anti-fog Window Cleaner
per blind!**

Also, 360° is doing a 5 blind giveaway
To all 360° customers that buy in the
month of Feb. Get your name in the
Drawing! See you at the Mec!



Discounts on all Real World
products, including Giant Miscanthus.



CLOVERLEAF
Outdoors LLC

(269)-483-1314
18045 US 12
White Pigeon, MI

Closed Tuesdays-Sundays.
Monday-Wednesday-
Thursday-Friday 9:30-4:30.
Saturday 9:30-2:00pm

*Working together to
ensure the future of
wildlife habitat.*



**MICHIANA'S PREMIER OUTDOOR TRADE SHOW
FEB. 19TH-21ST, 2026**

THOUSANDS OF DOLLARS IN GIVEAWAYS. FUN FOR THE WHOLE FAMILY.

ADMISSION \$15.00 - KIDS 12 UNDER FREE

**NEW THIS YEAR:
ART SHOW & BAKING
CONTEST**

For More info visit our
website or call our hotline

**BACK AGAIN:
CHASING GIANTS**

Hosting a live podcast
and other exciting
events.

GUN AUCTION
Starts Saturday at 10 am

**Michiana Monsters Big
Buck Hall of Fame**

Visit the Michiana
Monsters Facebook Page for
more info.

Sponsored by:



"Into the Wilds" BRENT HENDERSON

Brent is a author and outdoorsman, has endured harrowing close-calls—from a 500-foot wall of ice calvin from Holgate Glacier to bear encounters, to being attacked by a bison, a rhino, a 400-pound Russian boar, a whitetail buck, and a red stag. Don't miss his on-stage stories Thursday and Friday.



Friday and Saturday
3 Shows Per Day



THE MEC - 455 E Farver Street Shipshewana, IN

Midwestsportsmenclassic.com 574.354.6030

charity@midwestsportsmenclassic.com

Robert A. Yoder

BENEFIT RAFFLE

On September 10 2025, Robert Yoder was diagnosed with AML leukemia. He spent the first 32 days at Cleveland Clinic undergoing chemotherapy. As of Christmas, he is in remission, but he still needs to complete two additional phases of chemotherapy.

Raffle tickets can be purchased by mail with check payable to "Carr Road Church" and send to 10435 Hacket Road Apple Creek, Ohio 44606, OR in person at Northeast Ohio Sportsman's show at the Mt. Hope Event Center, Jan 15-17.

Drawing will be February 20th 2026.

Winner will be notified by mail or by phone.

1st Garmin Livescope



2nd 6.5 Creedmoor



3rd Tenpoint crossbow



4th Vortex spotting scope



5th Yeti cooler & fishing package



Thank you for your donation, may God bless you!

GOD'S LOVE FOR THE MARGINALIZED



The Lord sees every person, even in their lowest moments.

Throughout Scripture, God shows a special concern for those pushed to the margins—people others avoided, judged, or forgot...

Whether it was the leper no one dared touch, the woman suffering alone, or the tax collector hated by his community, their stories all point to the same truth: no one is beyond God's reach. Time and again, Jesus stepped toward the outcasts when everyone else stepped away.

These accounts remind us that the Lord sees every person, even in their lowest and loneliest moments. Hagar in the wilderness, Leah in her heartache, the Samaritan woman with a painful past, and even the prodigal son who wandered by choice—each discovered that the Lord meets people right where they are and restores what others have dismissed. Their lives changed not because they were perfect, but because God's grace was greater than their circumstances.

That same hope belongs to the men and women behind bars today.

Prison walls do not hide anyone from God's eyes or love. Through prison ministry, we have the privilege of bringing this message of grace, dignity, and new beginnings to those who desperately need to hear it.

Join us in reaching the forgotten in prison, reminding them that their story is not over and that God still welcomes outcasts—because He came to restore us all.

DONATE TODAY TO HELP REACH PRISON OUTCASTS:



Mail: Christmas Behind Bars, PO Box 474, Bluffton, IN 46714

Credit Card: Call 260-827-8835

Online: Visit www.ChristmasBehindBars.org/donate

SHADY LANE CURTAINS AUTHORIZED DEALER



We are happy to introduce our latest dealer in the Michiana area covering the Michiana territory



SHADY LANE Curtains LLC



The Industry Leader in AG Curtains

Maximum protection in the Winter & Ventilation in the Summer.

MADE IN THE USA

**Most Durable
Longevity
7 Year Warranty**

**Call today for short lead time installations
michianaequipment.com | 547-642-4768**

THE BUSY BEAVER™ travels to over 16,610 Plain homes throughout Michigan and Indiana. It is a weekly publication, mailed FREE to Old Order Amish patrons as an advertising source to intertwine our communities. All others may subscribe to this publication for \$50.00 a year. This rate is to USA residents only.

Copyright © Busy Beaver Publications, LLC™ 2016-2026

FLOORING SALE

- 2 ¼" Or 3 ¼" Red Or White Oak
- ¾" Thick, Tongue & Groove, End-Matched
- #2 Common & Better, Very Nice Flooring
- \$2.10 Per Square Foot
- Delivery Must Take 2000 Sq. Ft. Or More For Quantity Discount

Also in stock:
 Very Nice Prefinished Hickory
 2 ¼" or 3 ¼" for
\$3.30
 Many other Choice Available

Benches, Chairs, Beds, Recliners-Rockers, Hutches, Desks, Hoosier Cabinets

Leave a message or write, for Oak, Gifts, Glassware and More!

Bender's Furniture

8241 Prattville Rd Pittsford MI 49271
517-554-8488

Swing-A-Round

TWO MODELS AVAILABLE

3 Arm: 8' high by 14' diameter

\$2500.00

6 Arm: 10' high by 20' diameter

\$3750.00

Powder coated steel, stainless steel bolts

ASSORTMENT OF COLORS AVAILABLE

Children really LOVE it!

Spins in a circle!

Indiana residents add 7% Sales Tax



Sales

9951 DICKEY ROAD MARYSVILLE, INDIANA 47141

812-289-1274



MICHIGAN FOOD PLOT SUPPLY
269-550-7974

Whitetail Consultation Plan Implementation

- Custom Planting Service
- Miscanthus Planting
- Soil Management
- Tillage & Weed Control



*Makita
ITEM #4101



Makita
ITEM #4101
\$75.00



DeWalt
ITEM #4102
\$75.00



Milwaukee
ITEM #4103
\$75.00

AVAILABLE IN:

Makita

Milwaukee

DEWALT

Niitzlicht Hanging Light

Transform YOUR HOME TODAY!

Questions or to place an Order

Anthony & Loretta Miller

PH#: 574-821-1520
10766 County Road 16
Middlebury, IN 46540



Homestead lights

Niitzlicht - \$54.00
Inverters - \$75.00

AVAILABLE IN:

Makita

DEWALT

* OFFERING REPAIRS ON LIGHTS

* UPS & USPS SHIPPING

* OPEN WHEN HOME

* CALL FOR A FREE CATALOG